

SITETALK WRESTLING WORLD CHAMPIONSHIPS



BUDAPEST (HUN)

2013-09-16 - 2013-09-22 2013

Résultats - Results

Lutte Libre - Free-Style



**Liste des arbitres / Referee list****Sitetalk Wrestling World Championships**

N°	Licence	Pays Country	Nom - Last Name	Prénom - First Name
	4675	AZE	JAFAROV	Azhdar
	4037	AZE	SHARIFOV	Hijran
	4696	BLR	BREL	Ihar
		BRA	CONCALVES	Eduardo
	2214	BUL	ALEXANDROV	Levon
		BUL	GOCHEV	Miroslav
	4633	BUL	GUETZOV	Valentin Dotchev
	3106	BUL	KOSTADINOV	Iantcho
		CAN	MACKAY	Lee
	4308	CHN	SUN	Jian
	3291	CHN	ZHANG	Xia
	2829	CRO	OCIC	Zvonko
	3364	CRO	PETANJEK	Davor
		CUB	MOLINA	Orestes
		CUB	RODRIGUEZ	Manuel
	4828	CZE	SCHEINER	Vaclav
		DEN	ATAY ZEYNEL	Lutfu
	4097	EGY	MOUSTAFA	Ibrahim Adel
	4177	ESP	GARCIA	Carlos
	2082	FIN	VEHVILÄ,INEN	Pertti
	2546	FRA	LEGLEUT	RÃ©gine
		FRA	MENU HRISTOV	Celine
	2513	GEO	MACHAIDZE	Edisher
		GER	MANZ	Uwe
		GRE	MIGIPI	Anastasia
	4357	HUN	BACSA	PÃ©ter
	3456	HUN	PÃ©TERI	LÃ©szlÃ© ³
	3051	IRI	RAMEZAN NEJAD	Ramezan Ali
		IRI	TALEBI	Bahman
	4112	IRQ	QASSIM	Ali
	4670	ISR	SHMUELY	Aviram
	4356	ITA	DÃ©ZSA	Edit
		ITA	MASI	Marco
	3218	JPN	ASHIDA	Takaharu
	4702	JPN	OKIYAMA	Isao
		JPN	SAITO	Osamu
	4697	KAZ	JAXYKULOV	Bakhytzhan
	3348	KGZ	AHMETOV	Meyrambek
	3349	KGZ	KULMATOV	Kochkor

**Liste des arbitres / Referee list****Sitetalk Wrestling World Championships**

N°	Licence	Pays Country	Nom - Last Name	Prénom - First Name
		KOR	CHUNG	Tong Kun
	2385	MAR	MOCHAFFAA	Noreddine
	4362	MGL	TUMURBAATAR	Baatar
	5034	NED	ABDOELAEV	Edmar
	3077	POL	BRUDZINSKI	Grzegorz
	3359	POL	LEBKOWSKI	Karol
	4150	ROU	GYARMATI	Ferenc
	2541	ROU	LAZAR	Ovidiu
	4729	RUS	ARUSTAMYAN	Noravard
	3749	RUS	KRIKOV	Andrey
	3267	RUS	NOVAKOVSKIY	Sergey
		SAM	VILLET	Charles
	3408	SLO	SERNEK	Stanislav
	4386	SVK	VOJKOVIC	Miroslav
		SWZ	PUTALLAZ	Alain
		TPE	JANG	Tsong Rong
	3520	TUR	CICIOGLU	Halil Ibrahim
	4433	TUR	SEN	Levent
	3623	TUR	YUCEL	Sadettin
	4192	USA	DAVIS	Stacey
	3924	USA	ERRETT	Zachary David
		USA	GOESSEL	Casey
		USA	JULIAN	Sam
	3284	UZB	GULAMOV	Tokhir
		UZB	KONSTANTIN	Mikhailov

Nombre d'arbitres - Number of Referee

64



Liste des nations / Countries List

Sitetalk Wrestling World Championships



STYLE FS

Pays - Country

	AFRIQUE DU SUD	RSA
	ALBANIE	ALB
	ALLEMAGNE	GER
	ARGENTINE	ARG
	ARMENIE	ARM
	AUSTRALIE	AUS
	AUTRICHE	AUT
	AZERBAIDJAN	AZE
	BELARUS	BLR
	BRESIL	BRA
	BULGARIE	BUL
	CANADA	CAN
	CHINE	CHN
	COLOMBIA	COL
	COREE	KOR
	COREE RDP	PRK
	CUBA	CUB
	DOMINICA	DOM
	EGYPTE	EGY
	ESPAGNE	ESP
	ESTONIE	EST
	FINLANDE	FIN
	FRANCE	FRA
	GEORGIE	GEO
	GREECE	GRE
	GUATEMALA	GUA
	GUINEE-BISSAU	GBS
	HONDURAS	HON
	HONGRIE	HUN
	INDIA	IND
	IRAK	IRQ
	IRAN R.I.	IRI
	ISRAEL	ISR
	JAPON	JPN
	KAZAKHSTAN	KAZ
	KIRGIZSTAN	KGZ
	LETTONIE	LAT
	LITHUANIA	LTU
	MACEDOINE ANC. R. YUG	MKD
	MADAGASCAR	MAD
	MAURITIUS	MRI
	MEXICO	MEX
	MOLDAVIE	MDA
	MONGOLIE	MGL
	NOUVELLE-ZELANDE	NZL
	OUZBEKISTAN	UZB
	PALAU	PLW
	PEROU	PER





















Liste des nations / Countries List

Sitetalk Wrestling World Championships

STYLE FS



	POLOGNE	POL
	PORTO RICO	PUR
	QATAR	QAT
	ROUMANIE	ROU
	RUSSIE	RUS
	SALVADOR	ESA
	SENEGAL	SEN
	SERBIA	SRB
	SLOVAQUIE	SVK
	SRI LANKA	SRI
	SUISSE	SUI
	TADJIKISTAN	TJK
	TCHAD	CHA
	TCHEQUE REP.	CZE
	TURQUIE	TUR
	UKRAINE	UKR
	UNITED STATES	USA
	VENEZUELA	VEN
	VIETNAM	VIE

Nombre de nations - Number of Countries 67

**Nombre d'engagés par nation / Number of Entries By Country****Sitetalk Wrestling World Championships**

STYLE FS



<i>Pays - Country</i>	<i>120 KG</i>	<i>55 KG</i>	<i>60 KG</i>	<i>66 KG</i>	<i>74 KG</i>	<i>84 KG</i>	<i>96 KG</i>	<i>TOTAL</i>
ALB			1				1	2
ARG							1	1
ARM		1	1	1	1	1	1	6
AUS					1			1
AUT					1			1
AZE	1	1	1	1	1	1	1	7
BLR	1	1	1	1	1	1	1	7
BRA	1					1	1	3
BUL	1	1	1	1	1	1	1	7
CAN	1	1	1	1	1	1	1	7
CHA		1						1
CHN	1	1	1	1	1	1	1	7
COL				1		1		2
CUB			1	1	1	1		4
CZE							1	1
DOM				1	1	1		3
EGY			1	1	1			3
ESA			1					1
ESP		1				1		2
EST			1			1		2
FIN				1				1
FRA		1			1			2
GBS					1			1
GEO	1	1	1	1	1	1	1	7
GER	1	1		1	1	1	1	6
GRE	1			1	1	1	1	5
GUA					1			1
HON		1						1
HUN	1	1	1	1	1	1	1	7
IND	1	1	1	1	1	1	1	7
IRI	1	1	1	1	1	1	1	7
IRQ	1							1
ISR				1		1		2



Nombre d'engagés par nation / Number of Entries By Country

Sitetalk Wrestling World Championships

STYLE FS



<i>Pays - Country</i>	120 KG	55 KG	60 KG	66 KG	74 KG	84 KG	96 KG	TOTAL
JPN	1	1	1	1	1	1	1	7
KAZ	1	1	1	1	1	1	1	7
KGZ	1	1	1	1	1		1	6
KOR	1	1	1	1	1	1	1	7
LAT						1	1	2
LTU		1					1	2
MAD		1			1			2
MDA	1	1	1	1	1	1	1	7
MEX	1		1					2
MGL	1	1	1	1	1	1	1	7
MKD				1		1		2
MRI			1					1
NZL					1	1		2
PER			1					1
PLW	1							1
POL			1	1	1	1	1	5
PRK		1	1	1				3
PUR	1		1	1		1		4
QAT				1				1
ROU	1	1	1	1		1	1	6
RSA		1	1					2
RUS	1	1	1	1	1	1	1	7
SEN			1					1
SRB					1			1
SRI		1	1	1	1		1	5
SUI				1		1		2
SVK			1	1	1		1	4
TJK			1		1			2
TUR	1	1	1	1	1	1	1	7
UKR	1	1	1	1	1	1	1	7
USA	1	1	1	1	1	1	1	7
UZB	1	1	1	1	1	1		6
VEN	1	1	1	1		1	1	6



Nombre d'engagés par nation / Number of Entries By Country

Sitetalk Wrestling World Championships

STYLE FS



<i>Pays - Country</i>	<i>120 KG</i>	<i>55 KG</i>	<i>60 KG</i>	<i>66 KG</i>	<i>74 KG</i>	<i>84 KG</i>	<i>96 KG</i>	<i>TOTAL</i>
 VIE		1		1	1			3
TOTAL	29	34	39	40	39	37	33	251

Nombre de nations - Number of Countries 67



Liste des Engagés par pays / Entry-List By Country

Sitetalk Wrestling World Championships



STYLE FS

ALBANIA (ALB)

Chef de délégation / Team Leader : BIBA, Martin
Entraîneur / Coach : BRAHI, Fuat
SHALA, Sylejman

Lutteur(s) / Wrestler(s) :

60 kg NDREGJONI, Vilson
96 kg SHALA, Egzon

ARGENTINA (ARG)

Entraîneur / Coach : LEON, Erik

Lutteur(s) / Wrestler(s) :

96 kg MAIER, Yuri Alexei Horacio

ARMENIA (ARM)

Chef de délégation / Team Leader : BAGHDADYAN, Arayik
YENOKYAN, Hrant

Entraîneur / Coach : HOVSEPYAN, Hovsep
HOVHANNISYAN, Zhirayr
MAGAMEDOV, Abdula

Médecin / Medical Staff : KARAPETYAN, Ara
HARUTYUNYAN, Zaven

Kiné / Medical Staff : SARGSYAN, Telman
PETROSYAN, Artur

Lutteur(s) / Wrestler(s) :

55 kg JABURYAN, Mihran
60 kg ARAKELYAN, Artur
66 kg SAFARYAN, Devid
74 kg GRIGORYAN, Grigor
84 kg MURTAZALIEV, Musa
96 kg YENOKYAN, Edgar

AUSTRALIA (AUS)

Chef de délégation / Team Leader : ZASLAVSKY, Leonid

Lutteur(s) / Wrestler(s) :

74 kg LAWRENCE, Jayden Alexander



Liste des Engagés par pays / Entry-List By Country

Sitetalk Wrestling World Championships



STYLE FS

AUSTRIA (AUT)

Chef de délégation / Team Leader : HELMDACH, JÄrg

Entraîneur / Coach : CIKEL, Lubos

Kiné / Medical Staff : KLAUS, Erich

Lutteur(s) / Wrestler(s) :

74 kg MARCHL, Georg

AZERBAIJAN (AZE)

Chef de délégation / Team Leader : EYVAZOV, Tofig

RZAYEV, Yashar

Entraîneur / Coach : CHTEREV, Semyov

ALIOMAROV, Magomed

KURTSIYA, David

UMUDOV, Firdovsi

Médecin / Medical Staff : ALIYEV, Rauf

Kiné / Medical Staff : ISMAYILOV, Seymur

Lutteur(s) / Wrestler(s) :

120 kg MAGOMEDOV, Jamaladdin

55 kg ALIYEV, Yashar

60 kg ALIYEV, Haji

66 kg MUSTAFAYEV, Aghahuseyn

74 kg HASSANOV, Jabrayil

84 kg GOSTIEV, Alexander Taymurazovic

96 kg GAZYUMOV, Khetag

BELARUS (BLR)

Chef de délégation / Team Leader : KAZAUSKI, Aliaksandr

MEDVED, Aleksandr

Entraîneur / Coach : CHANKO, Ivan

SHEIKHAU, Ruslan

BELOGLAZOV, Anatoly

SHUBAYEU, Zhumatai

PANSTWA, Schengen

SCHENGENER, Staaten

SENGENO, VALSTYBES

YERMAK, Anatoli

MURZINKOU, Valiantsin

Médecin / Medical Staff : YAKAULEU, Aliaksandr

ZHUKOUSKI, Aliaksandr



Liste des Engagés par pays / Entry-List By Country

Sitetalk Wrestling World Championships



STYLE FS

Kiné / Medical Staff : MIKHAILOUSKI, Aliaksandr
HASPADARYK, Aliaksei

Lutteur(s) / Wrestler(s) :

120 kg	JALILAU, Yusup
55 kg	ANDREYEU, Uladzislau
60 kg	LACHINAU, Asadulla
66 kg	KONTOYEV, Alexandr
74 kg	SHABANAU, Ali
84 kg	GAIDAROV, Murad
96 kg	YANKOUSKI, Ivan

BRAZIL (BRA)

Chef de délégation / Team Leader : LEITAO, Roberto

Entraîneur / Coach : MALVINO, Daniel

Lutteur(s) / Wrestler(s) :

120 kg	JAOUDE, Antonie
84 kg	ABOU JAOUDE, Antoine
96 kg	IZIDORO BITTENCOURT, Juan Felipe

BULGARIA (BUL)

Entraîneur / Coach : RAYCHEV, Valentin
YANCHEV, Georgi
SUKRA, Rahmat
MIN CHEV, Nikolaz Georgiev
MIN CHEV, Nikolay Georgiev
KARADUSHEV, Georgi
SOFIADI, Rahmat

Médecin / Medical Staff : BORISOV, Boris
STRUGAROV, Stefan

Kiné / Medical Staff : TONCHEV, Marin
BORISOV, Emil

Lutteur(s) / Wrestler(s) :

120 kg	KUMCHEV, Dimitar Angelov
55 kg	DJOREV, Ivan
60 kg	DUBOV, Vladimir Vladimirov
66 kg	NOVACHKOV, Borislav Stefanov
74 kg	TERZIEV, Kiril Stoychev
84 kg	PASLAR, Nicolai Ivanovitch



Liste des Engagés par pays / Entry-List By Country

Sitetalk Wrestling World Championships



STYLE FS

96 kg

ILIEV, Lyuben Borisov

CANADA (CAN)

Chef de délégation / Team Leader : HOGARTH, Bill
Entraîneur / Coach : SISSAOURI, Gia
MCKAY, Dave
KIM, Kimin
Médecin / Medical Staff : BUDWAL, Surinder
CLEARLY, Victoria
Kiné / Medical Staff : TKACH, Rick

Lutteur(s) / Wrestler(s) :

120 kg	JARVIS, Korey
55 kg	PALANI, Aso
60 kg	PINEDA, John Manuel
66 kg	GARCIA, Haislan
74 kg	MACDONALD, Evan James
84 kg	TAGZIEV, Tamerlan
96 kg	SANDHU, Manjot

CHAD (CHA)

Lutteur(s) / Wrestler(s) :

55 kg	HERE, Hel
-------	-----------

CHINA (CHN)

Chef de délégation / Team Leader : XUE, Lian
Entraîneur / Coach : WANG, Keqin
LIANG, Dejin

Lutteur(s) / Wrestler(s) :

120 kg	DENG, Zhiwei
55 kg	HONG, Xiaobin
60 kg	MA, Cunjun
66 kg	ZHANG, Jianfu
74 kg	ZHANG, Chongyao
84 kg	ZHANG, Feng
96 kg	ZHANG, Xueyi

COLOMBIA (COL)



Liste des Engagés par pays / Entry-List By Country

Sitetalk Wrestling World Championships



STYLE FS

Entraîneur / Coach : GUTIERREZ, David
Médecin / Medical Staff : CHICA, Catalina
RIOS, Fernando

Lutteur(s) / Wrestler(s) :

66 kg	GUZMAN IPUZ, Hernan Dario
84 kg	MARTINEZ IBARGUEN, Juan Esteban

CUBA (CUB)

Chef de délégation / Team Leader : TELLEZ, Eduardo Perez
Entraîneur / Coach : CUELLAR, Julio Mendieta
Médecin / Medical Staff : CHACON, Siggilfredo Acosta

Lutteur(s) / Wrestler(s) :

60 kg	TABIER VALDES, Alejandro
66 kg	LOPEZ AZCUY, Livan
74 kg	BLANCO MORA, Yunierki
84 kg	SALAS PEREZ, Reineris

CZECH REPUBLIC (CZE)

Chef de délégation / Team Leader : VARGA, Ervin

Lutteur(s) / Wrestler(s) :

96 kg	CHOTAS, Vratislav
-------	-------------------

DOMINICA (DOM)

Chef de délégation / Team Leader : SABUA, Olgui
Entraîneur / Coach : MARTINEZ, Ramades

Lutteur(s) / Wrestler(s) :

66 kg	AVILA, Jeffry Manuel
74 kg	VALDEZ JEAN, Billy
84 kg	PEREZ SOSA, Luis Miguel

EGYPT (EGY)

Chef de délégation / Team Leader : EL-HADAD, Hassan
Entraîneur / Coach : MAHMOUD, Moustafa

Lutteur(s) / Wrestler(s) :

60 kg	IBRAHIM, Farg
66 kg	IBRAHIM, Ayad Ibrahim Khalil



Liste des Engagés par pays / Entry-List By Country

Sitetalk Wrestling World Championships



STYLE FS

74 kg

ABDOU, Omar

EL SALVADOR (ESA)

Lutteur(s) / Wrestler(s) :

60 kg

PORTILLO MEJIA, Luis Isaias

ESTONIA (EST)

Chef de délégation / Team Leader : PÄ-LLUSTE, Henn

Entraîneur / Coach : HAPOV, Aleksei

Médecin / Medical Staff : JAIRUS, Aleksander

Lutteur(s) / Wrestler(s) :

60 kg

BASKAKOV, Aleksei

84 kg

SOLTRUK , Jevgeni

FINLAND (FIN)

Chef de délégation / Team Leader : RAUHALA, Jukka

Médecin / Medical Staff : LEHTO, Mika

Kiné / Medical Staff : KURONEN, Hannu

Lutteur(s) / Wrestler(s) :

66 kg

HONKANEN, Tapani

FRANCE (FRA)

Chef de délégation / Team Leader : LAFON, Michel

BERTHOLOM, Alain

Entraîneur / Coach :

GONZALES AGUILERA, Daniel

VITALI, Eric

Médecin / Medical Staff :

VITALI, Eric

AISENBERG, Charles

Kiné / Medical Staff :

LASSUYE, Francois

MARTINEZ PACHECO, Lorenzo

Lutteur(s) / Wrestler(s) :

55 kg

EL OUARRAQE, Zoheir

74 kg

LAMPIS, Luca

GEORGIA (GEO)

Chef de délégation / Team Leader : KURTANIDZE, Luka-Eldar



Liste des Engagés par pays / Entry-List By Country

Sitetalk Wrestling World Championships



STYLE FS

Entraîneur / Coach :	POGOSIANI, Davit MINDORASHVILI, Revaz KAKHNIASHVILI, Aleksandre SKHIRELI, Nuozar
Médecin / Medical Staff :	KAKHABRISHVILI, Zurab
Kiné / Medical Staff :	PURTSELADZE, Mikheil KELIKHASHVILI, Jemal
Lutteur(s) / Wrestler(s) :	
120 kg	PETRIASHVILI, Geno
55 kg	EDISHERASHVILI, Giorgi
60 kg	KHINCHEGASHVILI, Vladimer
66 kg	KELEKHSASHVILI, Levan
74 kg	MAKARASHVILI, Jakob
84 kg	MARSAGISHVILI, Dato
96 kg	KERASHVILI, Dato

GERMANY (GER)

Chef de délégation / Team Leader :	SCHEIBE, Juergen ZAMANDURIDIS, Jannis
Entraîneur / Coach :	KAMM, Rainer THIELE, Sven GALWAS, Waldemar WALDERMAR, Galwas
Médecin / Medical Staff :	TRAGESER, Steffen GSTÄ-TTNER, Hans KLOTZ, Christian
Kiné / Medical Staff :	SCHRENKER, Klaus
Lutteur(s) / Wrestler(s) :	
120 kg	KESSEL, Johannes
55 kg	EWALD, Marcel
66 kg	BOLAGHI, Saba
74 kg	SHYYKA, Andriy
84 kg	SEREGELYI, Georg Gabriel
96 kg	HARTH, William

GREECE (GRE)

Entraîneur / Coach :	XENIDIS, Christoforos
Lutteur(s) / Wrestler(s) :	



Liste des Engagés par pays / Entry-List By Country

Sitetalk Wrestling World Championships



STYLE FS

120 kg	NYFADOPOYLOS, Christos
66 kg	TRIANATAYLLIDIS, Andreas
74 kg	SAVVOULIDIS, Georgios
84 kg	XENIDIS, Timofei
96 kg	TSIKOVANI, Micheil

GUATEMALA (GUA)

Lutteur(s) / Wrestler(s) :

74 kg	MARTINEZ CHEN, Pedro Orlando
-------	------------------------------

GUINEA-BISSAU (GBS)

Chef de délégation / Team Leader : SOARES DA GAMA, Aristoteles N.A.

Entraîneur / Coach : SOARES DA GAMA, Aristoteles N.A.

Lutteur(s) / Wrestler(s) :

74 kg	INTIPE, Quintina
-------	------------------

HONDURAS (HON)

Entraîneur / Coach : RODRIGUEZ, Osvel

Lutteur(s) / Wrestler(s) :

55 kg	ESCOBAR AMADOR, Brandon Jesus
-------	-------------------------------

HUNGARY (HUN)

Chef de délégation / Team Leader : MAROTHY, Istvan

Entraîneur / Coach : GULYAS, Istvan

Médecin / Medical Staff : BAKANEK, Gyorgy
DR. TEMESI, Laszlo

Kiné / Medical Staff : HADI, Gergely
GULYAS, Zsombor

Lutteur(s) / Wrestler(s) :

120 kg	LIGETI, Daniel
55 kg	KARDOS, Robert
60 kg	MOLNAR, Jozsef
66 kg	WOLLER, Gergo
74 kg	HATOS, Gabor
84 kg	VEREB, Istvan
96 kg	SZMIK, Attila



Liste des Engagés par pays / Entry-List By Country

Sitetalk Wrestling World Championships

STYLE FS



INDIA (IND)

Entraîneur / Coach :	VINOD, Kumar KUMAR, Virender MESTVIRISHVILI, Vladimer
Médecin / Medical Staff :	VIJAY, Vijay VIKAS, Vikas
Kiné / Medical Staff :	SHARMA, Rahul
Lutteur(s) / Wrestler(s) :	
120 kg	HITENDER, Hitender
55 kg	KUMAR, Amit
60 kg	BARJANG, Barjang
66 kg	KUMAR, Arun
74 kg	YADAV, Narsingh Pancham
84 kg	KUMAR, Pawan
96 kg	KADAYAN, Satywart

IRAN R.I. (IRI)

Chef de délégation / Team Leader :	BAYAT, Ali
Entraîneur / Coach :	TALAEI, Mohammad LAYEGH, Reza MOHAMMADI, Gholamreza ESMAEILPOUR, Mahmoud REZAEI, Alireza MAHBOUBI, SADEGH TAVAKOLIAN, Amir KHADEM, RASOUL
Médecin / Medical Staff :	AMIRSASAN, Ramin RASHIDLAMIR, Amir AZADBAKHT, Davood
Kiné / Medical Staff :	KOVARI, Mohammad
Lutteur(s) / Wrestler(s) :	
120 kg	GHASEMI, Komeil Nemat
55 kg	RAHIMI, Hassan Farman
60 kg	ESMAEILPOORJOUYBARI, Masoud Mahmoud
66 kg	TAGHAVI KERMANI, Mehdi Sadegh
74 kg	AKBARIZARINKOLAEI, Ezzatollah Abbas
84 kg	LASHGARI, Ehsan Naser
96 kg	YAZDANY, Reza



Liste des Engagés par pays / Entry-List By Country

Sitetalk Wrestling World Championships

STYLE FS



IRAQ (IRQ)

Entraîneur / Coach : HASSOON, Jamal Naser

Lutteur(s) / Wrestler(s) :

120 kg SAKLAWI, Mohammed Sabah Abdulmalek

ISRAEL (ISR)

Chef de délégation / Team Leader : SHULMAN, Leonid

Entraîneur / Coach : SHULMAN, Leonid

Lutteur(s) / Wrestler(s) :

66 kg GERTNER, Igor

84 kg TSOTSELASHVILI, Michael

JAPAN (JPN)

Chef de délégation / Team Leader : MARUYAMA, Hideji

HASE, Hiroshi

TANIOKA, Kuniko

Entraîneur / Coach : TAKADA, Yuji

OSAWA, Tomohiro

TANABE, Chikara

MATSUNAGA, Tomohiro

SUZUKI, Yutaka

KODAIRA, Kiyotaka

WADA, Takahiro

SAITO, Masashi

Médecin / Medical Staff : NAGAO, Shigeno

MASUJIMA, Atsushi

NAKAJIMA, Kohei

Kiné / Medical Staff : TAKAHASHI, Asuka

KAWASAKI, Atsushi

Lutteur(s) / Wrestler(s) :

120 kg ANOBUYOSHI, Arakida

55 kg INABA, Yasuhiro

60 kg MAEDA, Shogo

66 kg INOUE, Takahiro

74 kg TAKATANI, Sohuke

84 kg MATSUMOTO, Shinya

96 kg YAMAGUCHI, Takeshi



Liste des Engagés par pays / Entry-List By Country

Sitetalk Wrestling World Championships



STYLE FS

KAZAKHSTAN (KAZ)

Chef de délégation / Team Leader :	UMRALIYEV, Ruslan
Entraîneur / Coach :	ZHOLAMANOV, Kuandyk AMANOV, Abutalip ABDRASHEV, Askar ONGGARBAIUY, Altay UNDEMESEV, Ungarbay
Médecin / Medical Staff :	KLIPAN, Andrey
Kiné / Medical Staff :	KLIPAN, Sairan
Lutteur(s) / Wrestler(s) :	
120 kg	SHABANBAY, Daulet
55 kg	KALIYEV, Rassul
60 kg	NIYAZBEKOV, Daulet
66 kg	ZHUMAGAZYEV, Dauren
74 kg	TANATAROV, Akzhurek
84 kg	KAKHIDZE, Aslan
96 kg	TIGIYEV, Taimuraz

KYRGYZSTAN (KGZ)

Chef de délégation / Team Leader :	USHAKOV, Vadim
Entraîneur / Coach :	TABALDY UULU, Suimonkul MADZHINOV, Ruslanbek MUSAEV, Magomed IAKOVLEV, Budimir SIVTCEV, Ivan
Médecin / Medical Staff :	ALISHEVA, Baktygul
Lutteur(s) / Wrestler(s) :	
120 kg	LAZAREV, Aiaal
55 kg	ALYMBAEV, Altynbek
60 kg	BAZARGUREV, Bazar
66 kg	MAMATOV, Ulukman
74 kg	INNOKENTEV, Innokentii
96 kg	KRUPNYAKOV, Alexey

LATVIA (LAT)

Chef de délégation / Team Leader :	URBANCIKS, Dzintars
Entraîneur / Coach :	KURSITIS, Sergejs
Lutteur(s) / Wrestler(s) :	



Liste des Engagés par pays / Entry-List By Country

Sitetalk Wrestling World Championships



STYLE FS

84 kg ZVIRBULIS, Armands
96 kg LAGODSKIS, Imants

LITHUANIA (LTU)

Entraîneur / Coach : KASIMOVAS, Segejus

Lutteur(s) / Wrestler(s) :

55 kg SARUNAS, Jurcys
96 kg SIMAS, Asaciovas

MACEDONIA ANC. R. YUG (MKD)

Chef de délégation / Team Leader : NIKOLOVSKI, Cedo

Entraîneur / Coach : VRENEZI, Ljulzim

Lutteur(s) / Wrestler(s) :

66 kg MITROV, Dejan
84 kg BOGDANOV, Dejan

MADAGASCAR (MAD)

Chef de délégation / Team Leader : SARR, Ibrahima

Entraîneur / Coach : MIN CHEV, Nikolay Georgiev

Lutteur(s) / Wrestler(s) :

55 kg ANDRIAMALALA, Bienvenu
74 kg RATOLOJANAHRY, Todison

MAURITIUS (MRI)

Lutteur(s) / Wrestler(s) :

60 kg GUILLAUME, Joseph Jockenson

MEXICO (MEX)

Lutteur(s) / Wrestler(s) :

120 kg RUIZ FLORES, Jesse Prudente
60 kg DIAZ, Brandon

MOLDOVA (MDA)

Chef de délégation / Team Leader : PEICOV, Victor

Entraîneur / Coach : BODISTEANU, Ruslan



Liste des Engagés par pays / Entry-List By Country

Sitetalk Wrestling World Championships



STYLE FS

BUIUCLI, Piotr

Lutteur(s) / Wrestler(s) :

120 kg	ROMANOV, Andrei
55 kg	GREC, Clim
60 kg	PERPELITA, Andrei
66 kg	SAVA, Mihail
74 kg	BURCA, Alexandru
84 kg	IANULOV, Piotr
96 kg	CEBAN, Nicolai

MONGOLIA (MGL)

Chef de délégation / Team Leader :	DOLGORSUREN, Dagvadorj
Entraîneur / Coach :	TSERENBAATAR, Tsogtbayar BYAMBARINCHIN, Bayaraa AVIRMED, Enkhee OYUNBILEG, Purevbaatar LUVSANDAMBA, Enkhbayar
Médecin / Medical Staff :	CHULUUN, Nasanbat
Kiné / Medical Staff :	MANDUUL, Tuvshintur MYAGMARSUREN, Sarantsatsral

Lutteur(s) / Wrestler(s) :

120 kg	JARGALSAIKHAN, Chuluunbat
55 kg	ERDENEBAT, Bekhbayar
60 kg	ENKHSAIKHAN, Nyam-Ochir
66 kg	GANZORIG, Mandakhnaran
74 kg	BATCHULUUN, Ankhbayar
84 kg	ORGODOL, Uitumen
96 kg	DORJKHAND, Khuderbulga

NEW ZEALAND (NZL)

Chef de délégation / Team Leader :	GRAYLING, Mark
Kiné / Medical Staff :	DAVIES, Andrea
Lutteur(s) / Wrestler(s) :	
74 kg	DAVIES, Clinton Richard Peter
84 kg	KELVIN, Joseph

NORTH KOREA (PRK)

Chef de délégation / Team Leader :	KIM, Il
---	---------



Liste des Engagés par pays / Entry-List By Country

Sitetalk Wrestling World Championships



STYLE FS

Entraîneur / Coach : RI, Chang Jong

Lutteur(s) / Wrestler(s) :

55 kg	YANG, Kyong Il
60 kg	HWANG, Ryon Ghak
66 kg	KANG, Jin Hyok

PALAU (PLW)

Chef de délégation / Team Leader : TEMENGIL, Florian

Lutteur(s) / Wrestler(s) :

120 kg	TEMENGIL, Florian Skilang
--------	---------------------------

PERU (PER)

Lutteur(s) / Wrestler(s) :

60 kg	HERRERA PASTOR, Abel Gerald
-------	-----------------------------

POLAND (POL)

Chef de délégation / Team Leader : WRONSKI, Andrzej
ZBIGNIEW, Grudzien
ORDACK, Artur

Entraîneur / Coach : GARMULEWICZ, Marek
ABDUSALAMOV, Yusup

Médecin / Medical Staff : JAKUBOWSKI, Adam

Kiné / Medical Staff : MARCIN, Krzysztozek

Lutteur(s) / Wrestler(s) :

60 kg	BIENKOWSKI, Krzysztof
66 kg	STATKIEWICZ, Rafal
74 kg	BRZOZOWSKI, Krystian
84 kg	BALAWENDER, Maciej Michal
96 kg	SKASKIEWICZ, Kamil Stanislaw

PUERTO RICO (PUR)

Chef de délégation / Team Leader : GARCIA, Manuel

Entraîneur / Coach : ROJAS, Pedro
SANDERSON, Cody

Médecin / Medical Staff : CARLSON, Jon

Lutteur(s) / Wrestler(s) :



Liste des Engagés par pays / Entry-List By Country

Sitetalk Wrestling World Championships



STYLE FS

120 kg	LOPEZ MORELL, Edgardo Juan
60 kg	GOMEZ MATOS, Franklin
66 kg	SOTO CORDERO, Pedro
84 kg	ESPINAL, Jaime Yusept

QATAR (QAT)

Entraîneur / Coach : ZYAR, Mohamad

Lutteur(s) / Wrestler(s) :

66 kg	IBRAHIM, Abdullrahman Ibrahim A.
-------	----------------------------------

ROMANIA (ROU)

Chef de délégation / Team Leader : RAZVAN LUCIAN, Pircalabu

Entraîneur / Coach : CIMPOERU, Aurel

Lutteur(s) / Wrestler(s) :

120 kg	CHINTOAN, Rares Daniel
55 kg	DUKOV, Andrei
60 kg	GUIDEA, Ivan
66 kg	BUCUR, George
84 kg	STEFAN, Gheorghita
96 kg	MANEA, Michael

RUSSIA (RUS)

Chef de délégation / Team Leader : FADZAEV, Arsen

ALEXANDRIDIS, Christakis

Entraîneur / Coach :

TEDEEV, Malik

GUSEYNOV, Magomed

YUSUPOV, Mairbek

ALEXANDRIDI, Christakis

BAZAEV, Artur

MODOSIAN, Vladimir

AZIZOV, Magomed

MUSULBES, David

TSEBOEV, Vladislav

MAGONEDOV, Khadzimurad

BAGAEV, Slavik

UMAROV, Zhaa

SAZHIDOV, Sazhid

TEDEEV, Dzambolat



Liste des Engagés par pays / Entry-List By Country

Sitetalk Wrestling World Championships



STYLE FS

	ZIRATOV, Rasid
	MARGIEV, Anatolii
	MINTULAEV, Olkhuzur
	RASHIDOV, Shamil
	MAGOMEDOV, Magomed
Médecin / Medical Staff :	TEBIEV, Umar
Kiné / Medical Staff :	KOROLIOV, Evgeny
	BESTAEV, Gvineriy
Lutteur(s) / Wrestler(s) :	
120 kg	GATCALOV, Khadzhimurat
55 kg	ISRAPILOV, Nariman
60 kg	GOIGEREEV, Bekhan Salavdinovitch
66 kg	KURBANALIEV, Magomed
74 kg	KHUBEZHTY, Kakhaber
84 kg	KUDIAMAGOMEDOV, Shamil
96 kg	BOLTUKAEV, Anzor

SENEGAL (SEN)

Chef de délégation / Team Leader :	SARR, Ibrahima
Lutteur(s) / Wrestler(s) :	
60 kg	DIATTA, Jean Bernard Diadia

SERBIA (SRB)

Médecin / Medical Staff :	DR. SIKIMIC, Steven
Lutteur(s) / Wrestler(s) :	
74 kg	EFENDIEV, Zaur

SLOVAKIA (SVK)

Entraîneur / Coach :	KOLLAR, Roman
	HIRJAK, Peter
Lutteur(s) / Wrestler(s) :	
60 kg	BOLOTNJUK, Mykola
66 kg	OBZERA, Peter
74 kg	PALINKAS, Dan
96 kg	JALOVJAR, Jozef



Liste des Engagés par pays / Entry-List By Country

Sitetalk Wrestling World Championships



STYLE FS

SOUTH AFRICA (RSA)

Chef de délégation / Team Leader : COETZEE, Nico
Entraîneur / Coach : COETZEE, Nico
Lutteur(s) / Wrestler(s) :
55 kg COETZEE, Marco
60 kg PLAATJIES, Marno Roaun Ronald

SOUTH KOREA (KOR)

Chef de délégation / Team Leader : KIM, Kyunghwan
CHUNG, Nakkyu
Entraîneur / Coach : PARK, Jangsoon
JUNG, Jinhyuk
JUNG, Soonwon
Médecin / Medical Staff : KIM, Deokwon
Kiné / Medical Staff : KIM, Youngil
Lutteur(s) / Wrestler(s) :
120 kg NAM, Kougjin
55 kg KIM , Sunggwon
60 kg LEE , Seung-Chul
66 kg JUNG , Youngho
74 kg LEE , Yunseok
84 kg LEE, Jae-Sung
96 kg KIM , Jaegang

SPAIN (ESP)

Chef de délégation / Team Leader : IGLESIAS, Francisco Javier
Entraîneur / Coach : CASTRO, Nicolas
Lutteur(s) / Wrestler(s) :
55 kg METREVELI VARTANOV, Levan
84 kg FRIEV NASKIDAEVA, Talmuraz

SRI LANKA (SRI)

Chef de délégation / Team Leader : GUNAWARDENA P., Erandika
Kiné / Medical Staff : RAIGAMA VIDANA, Arachchige Perera
Lutteur(s) / Wrestler(s) :
55 kg ASITHA MADUSANKA PEIRIS, Manuwel Peiris Waduge
60 kg EKANAYAKE MUDIYANSELAGE, Samitha Priyankara



Liste des Engagés par pays / Entry-List By Country

Sitetalk Wrestling World Championships



STYLE FS

66 kg	LIYANAGE, Roshan Indika
74 kg	NALIGAMAGE, Ishan Dammika Abeyrathna
96 kg	MADASING ACHCHILLAGE, Gamini

SWITZERLAND (SUI)

Chef de délégation / Team Leader : KUNG, Ludwig
KUNG, Ludwig

Lutteur(s) / Wrestler(s) :

66 kg	GRAF, Steven
84 kg	RIESEN, Marco Lukas

TAJIKISTAN (TJK)

Chef de délégation / Team Leader : SALAMSHO, Mukhabbatov
Entraîneur / Coach : SISOLYATIN, Ignat
Kiné / Medical Staff : SIRODJEV, Eshon

Lutteur(s) / Wrestler(s) :

60 kg	NOEV, Nikolay
74 kg	DZHALILOV, Gamid

TURKEY (TUR)

Chef de délégation / Team Leader : YERLIKAYA, Hamza
AKBAS, Oktay
YAVUZ, Hasan Ulas
YASAR, Hasan Huseyin

Entraîneur / Coach : SANLI, Yuksel
BEREKET, Adem
GULHAN, Ahmet
NASRULLAH, Baysal
CAKMAR, Abdullah
BAYSAL, Nasrullah

Médecin / Medical Staff : YAYUZ, Hasun Ulas

Kiné / Medical Staff : KISACIK, Tamer

Lutteur(s) / Wrestler(s) :

120 kg	AKGUL, Taha
55 kg	AKGUL, Sezar
60 kg	BAKIR, Erhan
66 kg	GOR, Yakup
74 kg	DEMIRTAS, Soner



Liste des Engagés par pays / Entry-List By Country

Sitetalk Wrestling World Championships

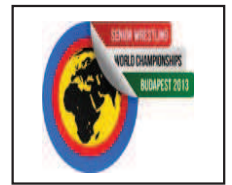

STYLE FS

84 kg BOKE, Serdar
96 kg YILDIRIM, Riza Ziyaettin

UKRAINE (UKR)

Chef de délégation / Team Leader : KHARENKO, Dina
Entraîneur / Coach : NAZARENKO, Yurii
SAVLOKHOV, Ruslan
DANKO, Grygorii
Médecin / Medical Staff : SHVANGYRADZE, Merab
Kiné / Medical Staff : BORODKOV, Sergiy
Lutteur(s) / Wrestler(s) :
120 kg ZASIEIEV, Alen
55 kg ARAKELIAN, Armen
60 kg AIVAZIAN, Mykola
66 kg RADULOV, Semen
74 kg CHYKHLADZE, Giya
84 kg ALDATOV, Ibragim
96 kg OLIINYK, Pavlo

UNITED STATES (USA)

Chef de délégation / Team Leader : KIEBLESZ, Paul
KELLEY, Christina
Entraîneur / Coach : MANNING, Mark
ROSSELLI, Lou
SANDERSON, Cael
SLAY, Brandon
JONES, Zeke
BRANDS, Tom
DUROE, Mike
DAKE, Kyle
Médecin / Medical Staff : ROBERTO, Fred
BOSWELL, Randy
WHIREN, Tony
RICE, Erika
DR. FELDMANN, Bernie
Kiné / Medical Staff : POITIER, Cyrus
Lutteur(s) / Wrestler(s) :
120 kg DLAGNEV, Tervel Ivaylov
55 kg ESCOBEDO, Angel Alesmo



Liste des Engagés par pays / Entry-List By Country

Sitetalk Wrestling World Championships



STYLE FS

60 kg	HUMPHREY, Reece Weslee
66 kg	METCALF, Brent Harold
74 kg	BURROUGHS, Jordan Ernest
84 kg	GAVIN, Keith Michael
96 kg	BERGMAN, James Daniel

UZBEKISTAN (UZB)

Entraîneur / Coach :	TAIROV, Ubaydulla NEDOREZOV, Aleksandr RUZIEV, Mamurjan
Médecin / Medical Staff :	ABAEVA, Elena

Lutteur(s) / Wrestler(s) :

120 kg	KURBANOV, Kurban
55 kg	SAFAROV, Nodirjon
60 kg	QURBANOV, Nasibullo
66 kg	PLIEV, Ruslan
74 kg	KURBANOV, Rashid
84 kg	SOKHIEV, Zaurbek

VENEZUELA (VEN)

Chef de délégation / Team Leader :	VALBUANA, Norman
Entraîneur / Coach :	DIAZ, Jose VAZQUEZ, Alberto DIAZ, Edward
Médecin / Medical Staff :	VASQUEZ MAIZO, Jhony Sneidel

Lutteur(s) / Wrestler(s) :

120 kg	VIVENES URBANEJA, Luis Felipe
55 kg	MEJIAS RODRIGUEZ, Pedro Jesus
60 kg	AGUILAR CANIZALEZ, Ibsen Antonio
66 kg	ROBERTTY MORENO, Cesar Augusto
84 kg	DIAZ ROBERTTI, Jose Daniel
96 kg	GONZALEZ ALVAREZ, Jhossier Enrique

VIETNAM (VIE)

Chef de délégation / Team Leader :	NGUYEN, The Long
Entraîneur / Coach :	DOI, Dang Hy TRAN, Van Son

Lutteur(s) / Wrestler(s) :



Liste des Engagés par pays / Entry-List By Country

Sitetalk Wrestling World Championships

STYLE FS



55 kg	NGUYEN, Huy Ha
66 kg	BUI, Tuan Anh
74 kg	CAN, Tat Du



Feuille de compétition / Competition Sheet

Sitetalk Wrestling World Championships



STYLE : FS 120 kg

QUALIFICATION			1/8 FINALE			1/4 FINALE			1/2 FINALE			FINALE		
1		HITENDER Hitender (IND)				1	0	IND	P1	P2	P3			
							0		0	0	0			
2		PETRIASHVILI Geno (GEO)				2	4	GEO	P1	P2	P3			
							8		8	0	0			
3		JALILAU Yusup (BLR)				3	0	BLR	P1	P2	P3			
							7		7	0	0			
4	3	CHINTOAN R. (ROU)	P1	P2	P3	4	5	ROU	P1	P2	P3			
	3		1	2	0		3		3	0	0			
5	0	KUMCHEV D. (BUL)	P1	P2	P3									
	0		0	0	0									
6	3	GATCALOV K. (RUS)	P1	P2	P3	6	4	RUS	P1	P2	P3			
	3		3	0	0		8		8	0	0			
7	1	KURBANOV Kurban (UZB)	P1	P2	P3									
	2		2	0	0									
8	1	SAKLAWI M. (IRQ)	P1	P2	P3	9	0	CAN	P1	P2	P3			
	2		0	2	0		0		0	0	0			
9	3	JARVIS Korey (CAN)	P1	P2	P3									
	3		2	1	0									
10	4	DENG Zhiwei (CHN)	P1	P2	P3	10	3	CHN	P1	P2	P3			
	10		6	4	0		7		7	0	0			
11	1	NAM Koungjin (KOR)	P1	P2	P3									
	3		1	2	0									
12	0	LOPEZ MORELL E. (PUR)	P1	P2	P3	13	1	HUN	P1	P2	P3			
	0		0	0	0		2		2	0	0			
13	5	LIGETI Daniel (HUN)	P1	P2	P3									
	3		3	0	0									
14	0	ROMANOV Andrei (MDA)	P1	P2	P3	15	1	MGL	P1	P2	P3			
	0		0	0	0		3		3	0	0			
15	4	JARGALSAIKHAN C. (MGL)	P1	P2	P3									
	7		3	4	0									
16	1	RUIZ FLORES J. (MEX)	P1	P2	P3	17	0	AZE	P1	P2	P3			
	2		2	0	0		0		0	0	0			
17	4	MAGOMEDOV J. (AZE)	P1	P2	P3	17	3	AZE	P1	P2	P3			
	10		4	6	0		4		4	0	0			
18	0	TEMENGIL F. (PLW)	P1	P2	P3	19	4	UKR	P1	P2	P3			
	0		0	0	0		7		7	0	0			
19	4	ZASIEIEV Alen (UKR)	P1	P2	P3									
	9		9	0	0									
20	0	NYFADOPOYLOS C. (GRE)	P1	P2	P3	21	0	TUR	P1	P2	P3			
	0		0	0	0		0		0	0	0			
21	4	AKGUL Taha (TUR)	P1	P2	P3									
	8		8	0	0									
22	4	ANOBUYOSHI arakida (JPN)	P1	P2	P3	22	0	JPN	P1	P2	P3			
	8		6	2	0		0		0	0	0			
23	0	VIVENES URBANEJA L. (VEN)	P1	P2	P3	24	4	USA	P1	P2	P3			
	0		0	0	0		7		7	0	0			
24	4	DLAGNEV T. (USA)	P1	P2	P3									
	9		9	0	0									
25	0	JAOUDE Antonie (BRA)	P1	P2	P3	25	0	USA	P1	P2	P3			
	0		0	0	0		7		7	0	0			
26	0	KESSEL Johannes (GER)	P1	P2	P3	27	1	KGZ	P1	P2	P3			
	0		0	0	0		1		1	0	0			
27	3	LAZAREV Aiaal (KGZ)	P1	P2	P3									
	4		1	3	0									
28	1	SHABANBAY Daulet (KAZ)	P1	P2	P3	28	1	IRI	P1	P2	P3			
	2		0	2	0		3		3	0	0			
29	3	GHASEMI K. (IRI)	P1	P2	P3									
	6		6	0	0									

6 GATCALOV K. (RUS)

Classement

Cl	Pays	Nom
1	RUS	GATCALOV Khadzhimurat
2	UKR	ZASIEIEV Alen
3	GEO	PETRIASHVILI Geno
3	TUR	AKGUL Taha
5	CHN	DENG Zhiwei
5	USA	DLAGNEV Tervel Ivaylov
7	ROU	CHINTOAN Rares Daniel
8	AZE	MAGOMEDOV Jamaladdin
9	HUN	LIGETI Daniel
10	IRI	GHASEMI Komeil Nemat
11	MGL	JARGALSAIKHAN Chuluunbat
12	JPN	ANOBUYOSHI arakida
13	UZB	KURBANOV Kurban
14	KGZ	LAZAREV Aiaal
15	CAN	JARVIS Korey
16	KOR	NAM Koungjin
17	IRQ	SAKLAWI Mohammed Sabah Abdur
18	KAZ	SHABANBAY Daulet
19	MEX	RUIZ FLORES Jesse Prudente
20	BLR	JALILAU Yusup
21	PUR	LOPEZ MORELL Edgardo Juan
21	BUL	KUMCHEV Dimitar Angelov
23	GER	KESSEL Johannes
24	MDA	ROMANOV Andrei
25	GRE	NYFADOPOYLOS Christos
25	VEN	VIVENES URBANEJA Luis Felipe
25	IND	HITENDER Hitender
28	BRA	JAOUDE Antonie
29	PLW	TEMENGIL Florian Skilang

REPECHAGE

REPECHAGE FINALISTE 1

7	3	UZB	P1	P2	P3	7	0	UZB	P1	P2	P3			
	7		7	0	0		2		2	0	0			
9	1	CAN	P1	P2	P3	10	5	CHN	P1	P2	P3			
	2		2	0	0		3		3	0	0			

2 | PETRIASHVILI Geno (GEO)

Mdaille de Bronze

REPECHAGE FINALISTE 2

18	0	PLW	P1	P2	P3	21	5	TUR	P1	P2	P3			
	0		0	0	0		7		7	0	0			
21	4	TUR	P1	P2	P3	17	0	AZE	P1	P2	P3			
	8		8	0	0		3		3	0	0			

21 | AKGUL Taha (TUR)

Mdaille de Bronze

**Classement****Sitetalk Wrestling World Championships**

STYLE : FS 120 kg

**1 - Or / Gold**

GATCALOV Khadzhimurat

2 - Argent / Silver

ZASIEIEV Alen

3 - Bronze

PETRIASHVILI Geno

AKGUL Taha

Classement	Nom - Name	Pays - Country
1	GATCALOV K.	RUS
2	ZASIEIEV Alen	UKR
3	PETRIASHVILI Geno	GEO
3	AKGUL Taha	TUR
5	DENG Zhiwei	CHN
5	DLAGNEV T.	USA
7	CHINTOAN R.	ROU
8	MAGOMEDOV J.	AZE
9	LIGETI Daniel	HUN
10	GHA SEMI K.	IRI
11	JARGALSAIKHAN C.	MGL
12	ANOBUYOSHI arakida	JPN
13	KURBANOV Kurban	UZB
14	LAZAREV Aiaal	KGZ
15	JARVIS Korey	CAN
16	NAM Koungjin	KOR
17	SAKLAW E M.	IRQ
18	SHABANBAY Daulet	KAZ
19	RUIZ FLORES J.	MEX
20	JALILAU Yusup	BLR
21	LOPEZ MORELL E.	PUR
21	KUMCHEV D.	BUL
23	KESSEL Johannes	GER
24	ROMANOV Andrei	MDA
25	NYFADOPOYLOS C.	GRE
25	VIVENES URBANEJA L.	VEN
25	HITENDER Hitender	IND
28	JAOUDE Antonie	BRA
29	TEMENGIL F.	PLW



Feuille de compétition / Competition Sheet

Sitetalk Wrestling World Championships



STYLE : FS 55 kg

QUALIFICATION				1/16 Finale				1/8 FINALE						
1	0	0	0	EL OUARRAQE Zoheir (FRA)	P1	P2	P3	0	0	0				
	0	0	0		P1	P2	P3	0	0	0				
2	0	0	0	HONG Xiaobin (CHN)	P1	P2	P3	0	0	0				
	0	0	0		P1	P2	P3	0	0	0				
3	0	0	0	KUMAR Amit (IND)	P1	P2	P3	0	0	0				
	0	0	0		P1	P2	P3	0	0	0				
4	0	0	0	INABA Yasuhiro (JPN)	P1	P2	P3	0	0	0				
	0	0	0		P1	P2	P3	0	0	0				
5	0	0	0	KARDOS Robert (HUN)	P1	P2	P3	0	0	0				
	0	0	0		P1	P2	P3	0	0	0				
6	0	0	0	SARUNAS Jurcys (LTU)	P1	P2	P3	0	0	0				
	0	0	0		P1	P2	P3	0	0	0				
7	0	0	0	ESCOBEDO A. (USA)	P1	P2	P3	0	0	0				
	0	0	0		P1	P2	P3	0	0	0				
8	0	0	0	DUKOV Andrei (ROU)	P1	P2	P3	0	0	0				
	0	0	0		P1	P2	P3	0	0	0				
9	0	0	0	ERDENEBAT B. (MGL)	P1	P2	P3	0	0	0				
	0	0	0		P1	P2	P3	0	0	0				
10	0	0	0	ALIYEV Yashar (AZE)	P1	P2	P3	0	0	0				
	0	0	0		P1	P2	P3	0	0	0				
11	0	0	0	MEJIAS RODRIGUEZ P. (VEN)	P1	P2	P3	0	0	0				
	0	0	0		P1	P2	P3	0	0	0				
12	0	0	0	PALANI Aso (CAN)	P1	P2	P3	0	0	0				
	0	0	0		P1	P2	P3	0	0	0				
13	0	0	0	SAFAROV Nodirjon (UZB)	P1	P2	P3	0	0	0				
	0	0	0		P1	P2	P3	0	0	0				
14	0	0	0	AKGUL Sezar (TUR)	P1	P2	P3	0	0	0				
	0	0	0		P1	P2	P3	0	0	0				
15	0	0	0	ASTHA MADUSANKA PEIRIS M. (SRI)	P1	P2	P3	0	0	0				
	0	0	0		P1	P2	P3	0	0	0				
16	0	0	0	GREC Clim (MDA)	P1	P2	P3	0	0	0				
	0	0	0		P1	P2	P3	0	0	0				
17	0	0	0	KALIYEV Rassul (KAZ)	P1	P2	P3	0	0	0				
	0	0	0		P1	P2	P3	0	0	0				
18	0	0	0	RAHIMI H. (IRI)	P1	P2	P3	0	0	0				
	0	0	0		P1	P2	P3	0	0	0				
19	0	0	0	ANDREYEU U. (BLR)	P1	P2	P3	0	0	0				
	0	0	0		P1	P2	P3	0	0	0				
20	0	0	0	KIM Sunggwon (KOR)	P1	P2	P3	0	0	0				
	0	0	0		P1	P2	P3	0	0	0				
21	0	0	0	ALYMBAEV Altynbek (KGZ)	P1	P2	P3	0	0	0				
	0	0	0		P1	P2	P3	0	0	0				
22	0	0	0	ESCOBAR AMADOR B. (HON)	P1	P2	P3	0	0	0				
	0	0	0		P1	P2	P3	0	0	0				
23	0	0	0	ANDRIAMALALA B. (MAD)	P1	P2	P3	0	0	0				
	0	0	0		P1	P2	P3	0	0	0				
24	0	0	0	ARAKELIAN Armen (UKR)	P1	P2	P3	0	0	0				
	0	0	0		P1	P2	P3	0	0	0				
25	0	0	0	NGUYEN Huy Ha (VIE)	P1	P2	P3	0	0	0				
	0	0	0		P1	P2	P3	0	0	0				
26	0	0	0	METREVELI VARTANOV L. (ESP)	P1	P2	P3	0	0	0				
	0	0	0		P1	P2	P3	0	0	0				
27	0	0	0	JABURYAN Mihran (ARM)	P1	P2	P3	0	0	0				
	0	0	0		P1	P2	P3	0	0	0				
28	0	0	0	EDISHERASHVILI G. (GEO)	P1	P2	P3	0	0	0				
	0	0	0		P1	P2	P3	0	0	0				
29	0	0	0	ISRAPILOV Nariman (RUS)	P1	P2	P3	0	0	0				
	0	0	0		P1	P2	P3	0	0	0				
30	0	0	0	YANG Kyong Il (PRK)	P1	P2	P3	0	0	0				
	0	0	0		P1	P2	P3	0	0	0				
31	4	8	0	DJOREV Ivan (BUL)	P1	P2	P3	8	0	0				
	0	0	0		P1	P2	P3	0	0	0				
32	0	0	0	HERE Hel (CHA)	P1	P2	P3	0	0	0				
	0	0	0		P1	P2	P3	0	0	0				
33	3	6	0	EWALD Marcel (GER)	P1	P2	P3	6	0	0				
	0	0	0		P1	P2	P3	0	0	0				
34	1	2	0	COETZEE Marco (RSA)	P1	P2	P3	2	0	0				
	0	0	0		P1	P2	P3	0	0	0				



Feuille de compétition / Competition Sheet

Sitetalk Wrestling World Championships

STYLE : FS 55 kg



Classement

Cl	Pays	Nom
1	IRI	RAHIMI Hassan Farman
2	IND	KUMAR Amit
3	TUR	AKGUL Sezar
3	RUS	ISRAPILOV Nariman
5	USA	ESCOBEDO Angel Alesmo
5	KAZ	KALIYEV Rassul
7	FRA	EL OUARRAQE Zoheir
8	KGZ	ALYMBAEV Altynbek
9	MGL	ERDENEBAT Bekhbayar
10	GEO	EDISHERASHVILI Giorgi
11	GER	EWALD Marcel
12	BUL	DJOREV Ivan
13	ESP	METREVELI VARTANOV Levan
14	UKR	ARAKELIAN Armen
15	MDA	GREC Clim
16	VEN	MEJIAS RODRIGUEZ Pedro Jesus
17	KOR	KIM Sunggwon
18	HUN	KARDOS Robert
19	PRK	YANG Kyong Il
20	JPN	INABA Yasuhiro

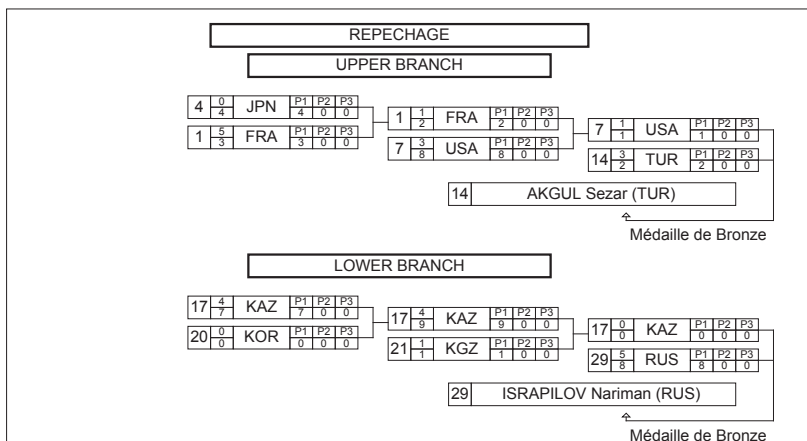

**Classement****Sitetalk Wrestling World Championships**

STYLE : FS 55 kg

**1 - Or / Gold**

RAHIMI Hassan Farman

2 - Argent / Silver

KUMAR Amit

3 - Bronze

AKGUL Sezar

ISRAPILOV Nariman

Classement	Nom - Name	Pays - Country
1	RAHIMI H.	IRI
2	KUMAR Amit	IND
3	AKGUL Sezar	TUR
3	ISRAPILOV Nariman	RUS
5	ESCOBEDO A.	USA
5	KALIYEV Rassul	KAZ
7	EL OUARRAQE Zoheir	FRA
8	ALYMBAEV Altynbek	KGZ
9	ERDENEBAT Bekhbayar	MGL
10	EDISHERASHVILI G.	GEO
11	EWALD Marcel	GER
12	DJOREV Ivan	BUL
13	METREVELI VARTANOV L.	ESP
14	ARAKELIAN Armen	UKR
15	GREC Clim	MDA
16	MEJIAS RODRIGUEZ P.	VEN
17	KIM Sunggwon	KOR
18	KARDOS Robert	HUN
19	YANG Kyong Il	PRK
20	INABA Yasuhiro	JPN
21	ANDRIAMALALA B.	MAD
22	SARUNAS Jurcys	LTU
23	ESCOBAR AMADOR B.	HON
24	ANDREYEU Uladzislau	BLR
25	ALIYEV Yashar	AZE
26	COETZEE Marco	RSA
26	JABURYAN Mihran	ARM
28	SAFAROV Nodirjon	UZB
28	HONG Xiaobin	CHN
30	DUKOV Andrei	ROU



Classement

Sitetalk Wrestling World Championships

STYLE : FS 55 kg



Classement	Nom - Name	Pays - Country
31	NGUYEN Huy Ha	VIE
31	PALANI Aso	CAN
31	ASITHA MADUSANKA PEIRIS M.	SRI
34	HERE Hel	CHA



Feuille de compétition / Competition Sheet

Sitetalk Wrestling World Championships

STYLE : FS 60 kg



Classement

Cl	Pays	Nom
1	RUS	GOIGEREEV Bekhan Salavdinovitch
2	BUL	DUBOV Vladimir Vladimirov
3	IND	BARJANG Barjang
3	IRI	ESMAELPOORJOUYBARI Masoud Mahmou
5	MGL	ENKHTSAIKHAN Nyam-Ochir
5	ARM	ARAKELIAN Artur
7	PUR	GOMEZ MATOS Franklin
8	USA	HUMPHREY Reece Weslee
9	ROU	GUIDEA Ivan
10	GEO	KHINCHEGASHVILI Vladimer
11	MDA	PERPELITA Andrei
12	SVK	BOLOTNJUK Mykola
13	CAN	PINEDA John Manuel
14	EST	BASKAKOV Aleksei
15	PRK	HWANG Ryon Ghak
16	KOR	LEE Seung-Chul
17	JPN	MAEDA Shogo
18	TUR	BAKIR Erhan
19	POL	BIENKOWSKI Krzysztof
20	BLR	LACHINAU Asadulla

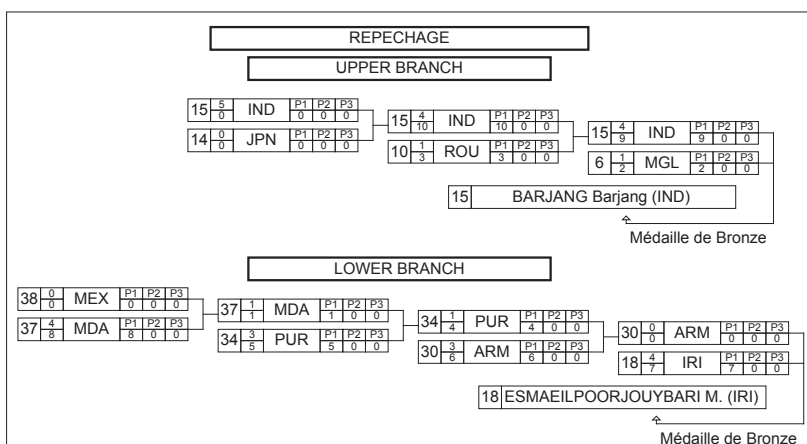

**Classement****Sitetalk Wrestling World Championships**

STYLE : FS 60 kg

**1 - Or / Gold**

GOIGEREEV Bekhan Salavdinovitch

2 - Argent / Silver

DUBOV Vladimir Vladimirov

3 - Bronze

BARJANG Barjang ESMAEILPOORJOUYBARI Masoud Mahmoud

Classement	Nom - Name	Pays - Country
1	GOIGEREEV B.	RUS
2	DUBOV V.	BUL
3	BARJANG Barjang	IND
3	ESMAEILPOORJOUYBARI M.	IRI
5	ENKHSAIKHAN N.	MGL
5	ARAKELIAN Artur	ARM
7	GOMEZ MATOS F.	PUR
8	HUMPHREY R.	USA
9	GUIDEA Ivan	ROU
10	KHINCHEGASHVILI V.	GEO
11	PERPELITA Andrei	MDA
12	BOLOTNJUK Mykola	SVK
13	PINEDA John Manuel	CAN
14	BASKAKOV Aleksei	EST
15	HWANG Ryon Ghak	PRK
16	LEE Seung-Chul	KOR
17	MAEDA Shogo	JPN
18	BAKIR Erhan	TUR
19	BIENKOWSKI K.	POL
20	LACHINAU Asadulla	BLR
21	NIYAZBEKOV Daulet	KAZ
22	HERRERA PASTOR A.	PER
23	TABIER VALDES A.	CUB
24	MOLNAR Jozsef	HUN
25	AGUILAR CANIZALEZ I.	VEN
26	NOEV Nikolay	TJK
27	NDREGJONI Vilson	ALB
28	MA Cunjun	CHN
29	PLAATJIES M.	RSA
30	ALIYEV Haji	AZE

**Classement****Sitetalk Wrestling World Championships**

STYLE : FS 60 kg



<i>Classement</i>	<i>Nom - Name</i>	<i>Pays - Country</i>
31	QURBANOV Nasibullo	UZB
32	AIVAZIAN Mykola	UKR
33	DIATTA J.	SEN
34	BAZARGUREV Bazar	KGZ
35	PORTILLO MEJIA L.	ESA
35	IBRAHIM Farg	EGY
37	GUILLAUME J.	MRI
37	EKANAYAKE MUDIYANSELAGE S.	SRI
39	DIAZ Brandon	MEX



Feuille de compétition / Competition Sheet

Sitetalk Wrestling World Championships



STYLE : FS 66 kg

QUALIFICATION			1/16 Finale			1/8 FINALE							
1	$\frac{4}{7}$	BUCUR George (ROU)	P1	P2	P3	7	0	0	1	MEJIA SAMBULA J. (HON)			
	$\frac{4}{7}$		P1	P2	P3	7	0	0					
2	$\frac{4}{7}$	SAFARYAN Devid (ARM)	P1	P2	P3	7	0	0	2	KAO Shih-Min (TPE)			
	$\frac{4}{7}$		P1	P2	P3	7	0	0					
3	$\frac{4}{7}$	AVILA J. (DOM)	P1	P2	P3	7	0	0	3	AVILA J. (DOM)			
	$\frac{4}{7}$		P1	P2	P3	7	0	0					
4	$\frac{4}{7}$	STATKIEWICZ Rafal (POL)	P1	P2	P3	7	0	0	4	STATKIEWICZ Rafal (POL)			
	$\frac{4}{7}$		P1	P2	P3	7	0	0					
5	$\frac{4}{7}$	GRAF Steven (SUI)	P1	P2	P3	7	0	0	5	GRAF Steven (SUI)			
	$\frac{4}{7}$		P1	P2	P3	7	0	0					
6	$\frac{4}{7}$	GOR Yakup (TUR)	P1	P2	P3	7	0	0	6	GOR Yakup (TUR)			
	$\frac{4}{7}$		P1	P2	P3	7	0	0					
7	$\frac{4}{7}$	KURBANALIEV M. (RUS)	P1	P2	P3	7	0	0	7	KURBANALIEV M. (RUS)			
	$\frac{4}{7}$		P1	P2	P3	7	0	0					
8	$\frac{4}{7}$	JUNG Youngho (KOR)	P1	P2	P3	7	0	0	8	JUNG Youngho (KOR)			
	$\frac{4}{7}$		P1	P2	P3	7	0	0					
9	$\frac{4}{7}$	TAGHAVI KERMANI M. (IRI)	P1	P2	P3	7	0	0	9	TAGHAVI KERMANI M. (IRI)			
	$\frac{4}{7}$		P1	P2	P3	7	0	0					
10	$\frac{4}{7}$	METCALF B. (USA)	P1	P2	P3	7	0	0	10	METCALF B. (USA)			
	$\frac{4}{7}$		P1	P2	P3	7	0	0					
11	$\frac{4}{7}$	IBRAHIM A. (QAT)	P1	P2	P3	7	0	0	11	IBRAHIM A. (QAT)			
	$\frac{4}{7}$		P1	P2	P3	7	0	0					
12	$\frac{4}{7}$	KONTOYEV Alexandr (BLR)	P1	P2	P3	7	0	0	12	KONTOYEV Alexandr (BLR)			
	$\frac{4}{7}$		P1	P2	P3	7	0	0					
13	$\frac{4}{7}$	IBRAHIM A. (EGY)	P1	P2	P3	7	0	0	13	IBRAHIM A. (EGY)			
	$\frac{4}{7}$		P1	P2	P3	7	0	0					
14	$\frac{4}{7}$	LIYANAGE R. (SRI)	P1	P2	P3	7	0	0	14	LIYANAGE R. (SRI)			
	$\frac{4}{7}$		P1	P2	P3	7	0	0					
15	$\frac{4}{7}$	KUMAR Arun (IND)	P1	P2	P3	7	0	0	15	KUMAR Arun (IND)			
	$\frac{4}{7}$		P1	P2	P3	7	0	0					
16	$\frac{4}{7}$	KELEKHSASHVILI L. (GEO)	P1	P2	P3	7	0	0	16	KELEKHSASHVILI L. (GEO)			
	$\frac{4}{7}$		P1	P2	P3	7	0	0					
17	$\frac{4}{7}$	TRIANAFYLLIDIS A. (GRE)	P1	P2	P3	7	0	0	17	TRIANAFYLLIDIS A. (GRE)			
	$\frac{4}{7}$		P1	P2	P3	7	0	0					
18	$\frac{4}{7}$	GUZMAN IPUZ H. (COL)	P1	P2	P3	7	0	0	18	GUZMAN IPUZ H. (COL)			
	$\frac{4}{7}$		P1	P2	P3	7	0	0					
19	$\frac{4}{7}$	MAMATOV Ulukman (KGZ)	P1	P2	P3	7	0	0	19	MAMATOV Ulukman (KGZ)			
	$\frac{4}{7}$		P1	P2	P3	7	0	0					
20	$\frac{4}{7}$	SAVA Mihail (MDA)	P1	P2	P3	7	0	0	20	SAVA Mihail (MDA)			
	$\frac{4}{7}$		P1	P2	P3	7	0	0					
21	$\frac{4}{7}$	ROBERTTY MORENO C. (VEN)	P1	P2	P3	7	0	0	21	ROBERTTY MORENO C. (VEN)			
	$\frac{4}{7}$		P1	P2	P3	7	0	0					
22	$\frac{4}{7}$	WOLLER Gergo (HUN)	P1	P2	P3	7	0	0	22	WOLLER Gergo (HUN)			
	$\frac{4}{7}$		P1	P2	P3	7	0	0					
23	$\frac{4}{7}$	GANZORIG M. (MGL)	P1	P2	P3	7	0	0	23	GANZORIG M. (MGL)			
	$\frac{4}{7}$		P1	P2	P3	7	0	0					
24	$\frac{4}{7}$	RADULOV Semen (UKR)	P1	P2	P3	7	0	0	24	RADULOV Semen (UKR)			
	$\frac{4}{7}$		P1	P2	P3	7	0	0					
25	$\frac{0}{0}$	MITROV Dejan (MKD)	P1	P2	P3	0	0	0	25	MITROV Dejan (MKD)			
	$\frac{0}{0}$		P1	P2	P3	0	0	0					
26	$\frac{4}{7}$	PLIEV Ruslan (UZB)	P1	P2	P3	7	0	0	26	PLIEV Ruslan (UZB)			
	$\frac{4}{7}$		P1	P2	P3	7	0	0					
27	$\frac{4}{8}$	BOLAGHI Saba (GER)	P1	P2	P3	8	0	0	27	BOLAGHI Saba (GER)			
	$\frac{4}{8}$		P1	P2	P3	8	0	0					
28	$\frac{0}{0}$	HONKANEN tapani (FIN)	P1	P2	P3	0	0	0	28	HONKANEN tapani (FIN)			
	$\frac{0}{0}$		P1	P2	P3	0	0	0					
29	$\frac{3}{3}$	GARCIA Haislan (CAN)	P1	P2	P3	3	0	0	29	GARCIA Haislan (CAN)			
	$\frac{3}{3}$		P1	P2	P3	3	0	0					
30	$\frac{1}{2}$	MUSTAFAYEV A. (AZE)	P1	P2	P3	2	0	0	30	MUSTAFAYEV A. (AZE)			
	$\frac{1}{2}$		P1	P2	P3	2	0	0					
31	$\frac{4}{8}$	ZHUMAGAZYEV D. (KAZ)	P1	P2	P3	8	0	0	31	ZHUMAGAZYEV D. (KAZ)			
	$\frac{4}{8}$		P1	P2	P3	8	0	0					
32	$\frac{0}{0}$	ZHANG Jianfu (CHN)	P1	P2	P3	0	0	0	32	ZHANG Jianfu (CHN)			
	$\frac{0}{0}$		P1	P2	P3	0	0	0					
33	$\frac{3}{5}$	INOUE Takahiro (JPN)	P1	P2	P3	5	0	0	33	INOUE Takahiro (JPN)			
	$\frac{3}{5}$		P1	P2	P3	5	0	0					
34	$\frac{1}{5}$	NOVACHKOV B. (BUL)	P1	P2	P3	5	0	0	34	NOVACHKOV B. (BUL)			
	$\frac{1}{5}$		P1	P2	P3	5	0	0					
35	$\frac{4}{8}$	LOPEZ AZCUY Livan (CUB)	P1	P2	P3	8	0	0	35	LOPEZ AZCUY Livan (CUB)			
	$\frac{4}{8}$		P1	P2	P3	8	0	0					
36	$\frac{0}{0}$	BUI Tuan Anh (VIE)	P1	P2	P3	0	0	0	36	BUI Tuan Anh (VIE)			
	$\frac{0}{0}$		P1	P2	P3	0	0	0					
37	$\frac{1}{1}$	SOTO CORDERO Pedro (PUR)	P1	P2	P3	1	0	0	37	SOTO CORDERO Pedro (PUR)			
	$\frac{1}{1}$		P1	P2	P3	1	0	0					
38	$\frac{3}{4}$	KANG Jin Hyok (PRK)	P1	P2	P3	4	0	0	38	KANG Jin Hyok (PRK)			
	$\frac{3}{4}$		P1	P2	P3	4	0	0					
39	$\frac{1}{1}$	OBZERA Peter (SVK)	P1	P2	P3	1	0	0	39	OBZERA Peter (SVK)			
	$\frac{1}{1}$		P1	P2	P3	1	0	0					
40	$\frac{3}{8}$	GERTNER Igor (ISR)	P1	P2	P3	8	0	0	40	GERTNER Igor (ISR)			
	$\frac{3}{8}$		P1	P2	P3	8	0	0					



Feuille de compétition / Competition Sheet

Sitetalk Wrestling World Championships

STYLE : FS 66 kg



Classement

Cl	Pays	Nom
1	ARM	SAFARYAN Devid
2	CUB	LOPEZ AZCUY Livan
3	RUS	KURBANALIEV Magomed
3	MGL	GANZORIG Mandakhnaran
5	PRK	KANG Jin Hyok
5	GEO	KELEKHSASHVILI Levan
7	GER	BOLAGHI Saba
8	CAN	GARCIA Haislan
9	JPN	INOUE Takahiro
10	BLR	KONTOYEV Alexandr
11	GRE	TRIANAFYLLIDIS Andreas
12	ROU	BUCUR George
13	TUR	GOR Yakup
14	KAZ	ZHUMAGAZYEV Dauren
15	EGY	IBRAHIM Ayad Ibrahim Khalil
16	UZB	PLIEV Ruslan
17	POL	STATKIEWICZ Rafal
18	KGZ	MAMATOV Ulukman
19	ISR	GERTNER Igor
20	HUN	WOLLER Gergo

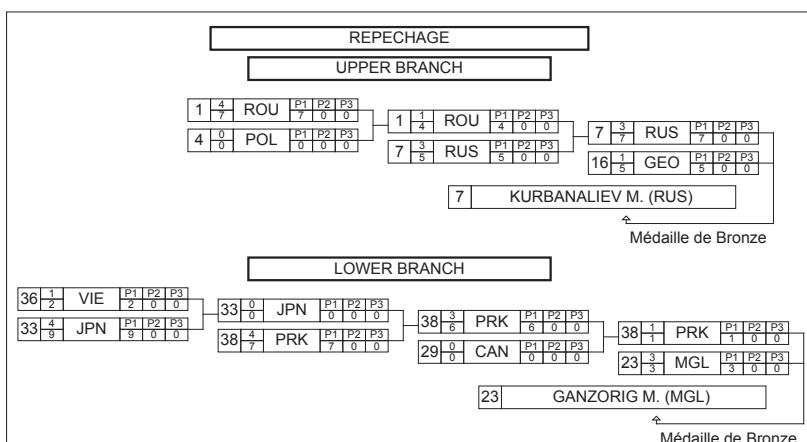

**Classement****Sitetalk Wrestling World Championships**

STYLE : FS 66 kg

**1 - Or / Gold**

SAFARYAN Devid

2 - Argent / Silver

LOPEZ AZCUY Livan

3 - Bronze

KURBANALIEV Magomed GANZORIG Mandakhnaran

Classement	Nom - Name	Pays - Country
1	SAFARYAN Devid	ARM
2	LOPEZ AZCUY Livan	CUB
3	KURBANALIEV Magomed	RUS
3	GANZORIG M.	MGL
5	KANG Jin Hyok	PRK
5	KELEKHSASHVILI L.	GEO
7	BOLAGHI Saba	GER
8	GARCIA Haislan	CAN
9	INOUE Takahiro	JPN
10	KONTOYEV Alexandr	BLR
11	TRANTAFYLLIDIS A.	GRE
12	BUCUR George	ROU
13	GOR Yakup	TUR
14	ZHUMAGAZYEV Dauren	KAZ
15	IBRAHIM A.	EGY
16	PLIEV Ruslan	UZB
17	STATKIEWICZ Rafal	POL
18	MAMATOV Ulukman	KGZ
19	GERTNER Igor	ISR
20	WOLLER Gergo	HUN
21	TAGHAVI KERMANI M.	IRI
22	SAVA Mihail	MDA
23	NOVACHKOV B.	BUL
24	GUZMAN IPUZ H.	COL
25	RADULOV Semen	UKR
26	MUSTAFAYEV A.	AZE
27	METCALF B.	USA
28	BUI Tuan Anh	VIE
29	SOTO CORDERO Pedro	PUR
30	OBZERA Peter	SVK

Classement**Sitetalk Wrestling World Championships**

STYLE : FS 66 kg



Classement	Nom - Name	Pays - Country
30	ROBERTTY MORENO C.	VEN
32	JUNG Youngho	KOR
33	IBRAHIM A.	QAT
33	MITROV Dejan	MKD
33	AVILA Jeffry Manuel	DOM
33	LIYANAGE R.	SRI
37	ZHANG Jianfu	CHN
37	GRAF Steven	SUI
37	KUMAR Arun	IND
37	HONKANEN tapani	FIN



Feuille de compétition / Competition Sheet

Sitetalk Wrestling World Championships



STYLE : FS 74 kg

QUALIFICATION			1/16 Finale			1/8 FINALE					
1	$\frac{3}{3}$	BATCHULUUN A. (MGL)	P1	P2	P3	3	0	0			
	$\frac{3}{3}$		P1	P2	P3	3	0	0	1	MEJIA SAMBULA J. (HON)	
2	$\frac{3}{3}$	HASSANOV Jabrayil (AZE)	P1	P2	P3	3	0	0			
	$\frac{3}{3}$		P1	P2	P3	3	0	0	2	KAO Shih-Min (TPE)	
3	$\frac{3}{3}$	TERZIEV K. (BUL)	P1	P2	P3	3	0	0			
	$\frac{3}{3}$		P1	P2	P3	3	0	0	3	TERZIEV K. (BUL)	
4	$\frac{3}{3}$	LAMPIS Luca (FRA)	P1	P2	P3	3	0	0			
	$\frac{3}{3}$		P1	P2	P3	3	0	0	4	LAMPIS Luca (FRA)	
5	$\frac{3}{3}$	KHUBEZHITY Kakhaber (RUS)	P1	P2	P3	3	0	0			
	$\frac{3}{3}$		P1	P2	P3	3	0	0	5	KHUBEZHITY Kakhaber (RUS)	
6	$\frac{3}{3}$	YADAV N. (IND)	P1	P2	P3	3	0	0			
	$\frac{3}{3}$		P1	P2	P3	3	0	0	6	YADAV N. (IND)	
7	$\frac{3}{3}$	DZHALILOV Gamid (TJK)	P1	P2	P3	3	0	0			
	$\frac{3}{3}$		P1	P2	P3	3	0	0	7	DZHALILOV Gamid (TJK)	
8	$\frac{3}{3}$	BURROUGHS J. (USA)	P1	P2	P3	3	0	0			
	$\frac{3}{3}$		P1	P2	P3	3	0	0	8	BURROUGHS J. (USA)	
9	$\frac{3}{3}$	SHYYKA Andriy (GER)	P1	P2	P3	3	0	0			
	$\frac{3}{3}$		P1	P2	P3	3	0	0	9	SHYYKA Andriy (GER)	
10	$\frac{3}{3}$	DEMIRTAS Soner (TUR)	P1	P2	P3	3	0	0			
	$\frac{3}{3}$		P1	P2	P3	3	0	0	10	DEMIRTAS Soner (TUR)	
11	$\frac{3}{3}$	MARCHL Georg (AUT)	P1	P2	P3	3	0	0			
	$\frac{3}{3}$		P1	P2	P3	3	0	0	11	MARCHL Georg (AUT)	
12	$\frac{3}{3}$	SHABANAU Ali (BLR)	P1	P2	P3	3	0	0			
	$\frac{3}{3}$		P1	P2	P3	3	0	0	12	SHABANAU Ali (BLR)	
13	$\frac{3}{3}$	VALDEZ JEAN Billy (DOM)	P1	P2	P3	3	0	0			
	$\frac{3}{3}$		P1	P2	P3	3	0	0	13	VALDEZ JEAN Billy (DOM)	
14	$\frac{3}{3}$	MARTINEZ CHEN P. (GUA)	P1	P2	P3	3	0	0			
	$\frac{3}{3}$		P1	P2	P3	3	0	0	14	MARTINEZ CHEN P. (GUA)	
15	$\frac{3}{3}$	GRIGORYAN Grigor (ARM)	P1	P2	P3	3	0	0			
	$\frac{3}{3}$		P1	P2	P3	3	0	0	15	GRIGORYAN Grigor (ARM)	
16	$\frac{3}{3}$	RATOLOJANAHRY T. (MAD)	P1	P2	P3	3	0	0			
	$\frac{3}{3}$		P1	P2	P3	3	0	0	16	RATOLOJANAHRY T. (MAD)	
17	$\frac{3}{3}$	SAVOULIDIS G. (GRE)	P1	P2	P3	3	0	0			
	$\frac{3}{3}$		P1	P2	P3	3	0	0	17	SAVOULIDIS G. (GRE)	
18	$\frac{3}{3}$	HATOS Gabor (HUN)	P1	P2	P3	3	0	0			
	$\frac{3}{3}$		P1	P2	P3	3	0	0	18	HATOS Gabor (HUN)	
19	$\frac{3}{3}$	CAN Tat Du (VIE)	P1	P2	P3	3	0	0			
	$\frac{3}{3}$		P1	P2	P3	3	0	0	19	CAN Tat Du (VIE)	
20	$\frac{3}{3}$	ZHANG Chongyao (CHN)	P1	P2	P3	3	0	0			
	$\frac{3}{3}$		P1	P2	P3	3	0	0	20	ZHANG Chongyao (CHN)	
21	$\frac{3}{3}$	ABDOU Omar (EGY)	P1	P2	P3	3	0	0			
	$\frac{3}{3}$		P1	P2	P3	3	0	0	21	ABDOU Omar (EGY)	
22	$\frac{3}{3}$	LEE Yunseok (KOR)	P1	P2	P3	3	0	0			
	$\frac{3}{3}$		P1	P2	P3	3	0	0	22	LEE Yunseok (KOR)	
23	$\frac{3}{3}$	EFENDIEV Zaur (SRB)	P1	P2	P3	3	0	0			
	$\frac{3}{3}$		P1	P2	P3	3	0	0	23	EFENDIEV Zaur (SRB)	
24	$\frac{3}{3}$	KURBANOV Rashid (UZB)	P1	P2	P3	3	0	0			
	$\frac{3}{3}$		P1	P2	P3	3	0	0	24	KURBANOV Rashid (UZB)	
25	$\frac{3}{3}$	TAKATANI Sohsume (JPN)	P1	P2	P3	3	0	0			
	$\frac{3}{3}$		P1	P2	P3	3	0	0	25	TAKATANI Sohsume (JPN)	
26	$\frac{0}{0}$	NALIGAMAGE I. (SRI)	P1	P2	P3	0	0	0			
	$\frac{0}{0}$		P1	P2	P3	0	0	0	26	NALIGAMAGE I. (SRI)	
27	$\frac{4}{7}$	CHYKHLADZE Giya (UKR)	P1	P2	P3	7	0	0			
	$\frac{4}{7}$		P1	P2	P3	7	0	0	27	CHYKHLADZE Giya (UKR)	
28	$\frac{4}{7}$	INTIPE Quintina (GBS)	P1	P2	P3	7	0	0			
	$\frac{4}{7}$		P1	P2	P3	7	0	0	28	INTIPE Quintina (GBS)	
29	$\frac{0}{0}$	DAVIES C. (NZL)	P1	P2	P3	0	0	0			
	$\frac{0}{0}$		P1	P2	P3	0	0	0	29	DAVIES C. (NZL)	
30	$\frac{4}{4}$	BRZOZOWSKI K. (POL)	P1	P2	P3	4	0	0			
	$\frac{4}{4}$		P1	P2	P3	4	0	0	30	BRZOZOWSKI K. (POL)	
31	$\frac{3}{5}$	TANATAROV Akzhurek (KAZ)	P1	P2	P3	5	0	0			
	$\frac{3}{5}$		P1	P2	P3	5	0	0	31	TANATAROV Akzhurek (KAZ)	
32	$\frac{4}{8}$	BLANCO MORA Y. (CUB)	P1	P2	P3	8	0	0			
	$\frac{4}{8}$		P1	P2	P3	8	0	0	32	BLANCO MORA Y. (CUB)	
33	$\frac{0}{0}$	LAWRENCE J. (AUS)	P1	P2	P3	0	0	0			
	$\frac{0}{0}$		P1	P2	P3	0	0	0	33	LAWRENCE J. (AUS)	
34	$\frac{4}{8}$	INNOKENTEV I. (KGZ)	P1	P2	P3	8	0	0			
	$\frac{4}{8}$		P1	P2	P3	8	0	0	34	INNOKENTEV I. (KGZ)	
35	$\frac{0}{0}$	PALINKAS Dan (SVK)	P1	P2	P3	0	0	0			
	$\frac{0}{0}$		P1	P2	P3	0	0	0	35	PALINKAS Dan (SVK)	
36	$\frac{1}{5}$	MACDONALD E. (CAN)	P1	P2	P3	5	0	0			
	$\frac{1}{5}$		P1	P2	P3	5	0	0	36	MACDONALD E. (CAN)	
37	$\frac{3}{8}$	MAKARASHVILI Jakob (GEO)	P1	P2	P3	8	0	0			
	$\frac{3}{8}$		P1	P2	P3	8	0	0	37	MAKARASHVILI Jakob (GEO)	
38	$\frac{1}{2}$	BURCA Alexandru (MDA)	P1	P2	P3	2	0	0			
	$\frac{1}{2}$		P1	P2	P3	2	0	0	38	BURCA Alexandru (MDA)	
39	$\frac{4}{10}$	AKBARIZARINKOLAEI E. (IRI)	P1	P2	P3	10	0	0			
	$\frac{4}{10}$		P1	P2	P3	10	0	0	39	AKBARIZARINKOLAEI E. (IRI)	



Feuille de compétition / Competition Sheet

Sitetalk Wrestling World Championships

STYLE : FS 74 kg



Classement

Cl	Pays	Nom
1	USA	BURROUGHS Jordan Ernest
2	IRI	AKBARIZARINKOLAEI Ezzatollah Abbas
3	BLR	SHABANAU Ali
3	UZB	KURBANOV Rashid
5	IND	YADAV Narsingh Panoram
5	GEO	MAKARASHVILI Jakob
7	JPN	TAKATANI Sohsuke
8	AZE	HASSANOV Jabrayil
9	ARM	GRIGORYAN Grigor
10	CUB	BLANCO MORA Yunierki
11	KAZ	TANATAROV Akzhurek
12	HUN	HATOS Gabor
13	KGZ	INNOKENTEV Innokentii
14	KOR	LEE Yunseok
15	GBS	INTIPE Quintina
16	UKR	CHYKHLADZE Giya
17	CHN	ZHANG Chongyao
18	GUA	MARTINEZ CHEN Pedro Orlando
19	TUR	DEMIRTAS Soner
20	FRA	LAMPIS Luca

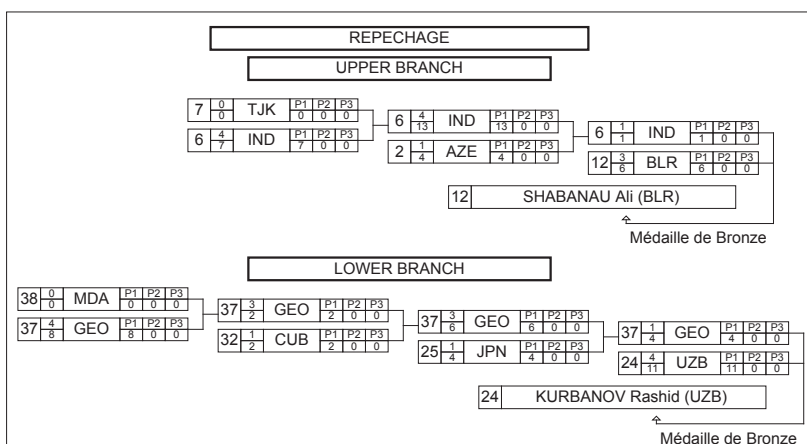



Classement

Sitetalk Wrestling World Championships

STYLE : FS 74 kg



1 - Or / Gold

BURROUGHS Jordan Ernest

2 - Argent / Silver

AKBARIZARINKOLAEI Ezzatollah Abbas

3 - Bronze

SHABANAU Ali

KURBANOV Rashid

<i>Classement</i>	<i>Nom - Name</i>	<i>Pays - Country</i>
1	BURROUGHS J.	USA
2	AKBARIZARINKOLAEI E.	IRI
3	SHABANAU Ali	BLR
3	KURBANOV Rashid	UZB
5	YADAV N.	IND
5	MAKARASHVILI Jakob	GEO
7	TAKATANI Sohsuke	JPN
8	HASSANOV Jabrayil	AZE
9	GRIGORYAN Grigor	ARM
10	BLANCO MORA Y.	CUB
11	TANATAROV Akzhurek	KAZ
12	HATOS Gabor	HUN
13	INNOKENTEV I.	KGZ
14	LEE Yunseok	KOR
15	INTIPE Quintina	GBS
16	CHYKHLADZE Giya	UKR
17	ZHANG Chongyao	CHN
18	MARTINEZ CHEN P.	GUA
19	DEMIRTAS Soner	TUR
20	LAMPIS Luca	FRA
21	VALDEZ JEAN Billy	DOM
22	MACDONALD E.	CAN
23	BRZOWSKI Krystian	POL
23	TERZIEV K.	BUL
25	SHYYKA Andriy	GER
26	KHUBEZHTY Kakhaber	RUS
27	DZHALILOV Gamid	TJK
28	BURCA Alexandru	MDA
29	SAVVOULIDIS G.	GRE
29	RATOLOJANAHRY T.	MAD



Classement

Sitetalk Wrestling World Championships

STYLE : FS 74 kg



<i>Classement</i>	<i>Nom - Name</i>	<i>Pays - Country</i>
29	DAVIES C.	NZL
29	NALIGAMAGE I.	SRI
29	BATCHULUUN A.	MGL
29	ABDOU Omar	EGY
29	CAN Tat Du	VIE
36	EFENDIEV Zaur	SRB
36	LAWRENCE J.	AUS
36	PALINKAS Dan	SVK
36	MARCHL Georg	AUT



Feuille de compétition / Competition Sheet

Sitetalk Wrestling World Championships



STYLE : FS 84 kg

QUALIFICATION			1/16 Finale			1/8 FINALE		
1	$\frac{4}{11}$	IANULOV Piotr (MDA)	P1	P2	P3	1		
	$\frac{4}{11}$		11	0	0			
2	$\frac{4}{11}$	MURTAZALIEV Musa (ARM)	P1	P2	P3	2		
	$\frac{4}{11}$		11	0	0			
3	$\frac{4}{11}$	BOGDANOV Dejan (MKD)	P1	P2	P3	3		
	$\frac{4}{11}$		11	0	0			
4	$\frac{4}{11}$	RIESEN Marco Lukas (SUI)	P1	P2	P3	4		
	$\frac{4}{11}$		11	0	0			
5	$\frac{4}{11}$	DIAZ ROBERTTI J. (VEN)	P1	P2	P3	5		
	$\frac{4}{11}$		11	0	0			
6	$\frac{4}{11}$	VEREB Istvan (HUN)	P1	P2	P3	6		
	$\frac{4}{11}$		11	0	0			
7	$\frac{4}{11}$	ALDATOV Ibragim (UKR)	P1	P2	P3	7		
	$\frac{4}{11}$		11	0	0			
8	$\frac{4}{11}$	SOLTRUK Jevgeni (EST)	P1	P2	P3	8		
	$\frac{4}{11}$		11	0	0			
9	$\frac{4}{11}$	GAIDAROV Murad (BLR)	P1	P2	P3	9		
	$\frac{4}{11}$		11	0	0			
10	$\frac{4}{11}$	LEE Jae-Sung (KOR)	P1	P2	P3	10		
	$\frac{4}{11}$		11	0	0			
11	$\frac{4}{11}$	GOSTIEV A. (AZE)	P1	P2	P3	11		
	$\frac{4}{11}$		11	0	0			
12	$\frac{4}{11}$	KAKHIDZE Aslan (KAZ)	P1	P2	P3	12		
	$\frac{4}{11}$		11	0	0			
13	$\frac{4}{11}$	ESPINAL J. (PUR)	P1	P2	P3	13		
	$\frac{4}{11}$		11	0	0			
14	$\frac{4}{11}$	STEFAN Gheorghita (ROU)	P1	P2	P3	14		
	$\frac{4}{11}$		11	0	0			
15	$\frac{4}{11}$	ORGODOL Uitumen (MGL)	P1	P2	P3	15		
	$\frac{4}{11}$		11	0	0			
16	$\frac{4}{11}$	ZVIRBULIS Armands (LAT)	P1	P2	P3	16		
	$\frac{4}{11}$		11	0	0			
17	$\frac{4}{11}$	ZHANG Feng (CHN)	P1	P2	P3	17		
	$\frac{4}{11}$		11	0	0			
18	$\frac{4}{11}$	KUMAR Pawan (IND)	P1	P2	P3	18		
	$\frac{4}{11}$		11	0	0			
19	$\frac{4}{11}$	TAGZIEV Tamerlan (CAN)	P1	P2	P3	19		
	$\frac{4}{11}$		11	0	0			
20	$\frac{4}{11}$	FRIEV NASKIDAeva T. (ESP)	P1	P2	P3	20		
	$\frac{4}{11}$		11	0	0			
21	$\frac{4}{11}$	MATSUMOTO Shinya (JPN)	P1	P2	P3	21		
	$\frac{4}{11}$		11	0	0			
22	$\frac{4}{11}$	BOKE Serdar (TUR)	P1	P2	P3	22		
	$\frac{4}{11}$		11	0	0			
23	$\frac{4}{11}$	PEREZ SOSA L. (DOM)	P1	P2	P3	23		
	$\frac{4}{11}$		11	0	0			
24	$\frac{4}{11}$	BALAWENDER M. (POL)	P1	P2	P3	24		
	$\frac{4}{11}$		11	0	0			
25	$\frac{4}{11}$	SALAS PEREZ R. (CUB)	P1	P2	P3	25		
	$\frac{4}{11}$		11	0	0			
26	$\frac{4}{11}$	SOKHIEV Zaurbek (UZB)	P1	P2	P3	26		
	$\frac{4}{11}$		11	0	0			
27	$\frac{4}{11}$	XENIDIS Timofei (GRE)	P1	P2	P3	27		
	$\frac{4}{11}$		11	0	0			
28	$\frac{0}{0}$	KELVIN Joseph (NZL)	P1	P2	P3	28		
	$\frac{0}{0}$		0	0	0			
29	$\frac{5}{8}$	SEREGELYI G. (GER)	P1	P2	P3	29		
	$\frac{5}{8}$		8	0	0			
30	$\frac{1}{2}$	TSOTSELASHVILI M. (ISR)	P1	P2	P3	30		
	$\frac{1}{2}$		2	0	0			
31	$\frac{4}{9}$	GAVIN K. (USA)	P1	P2	P3	31		
	$\frac{4}{9}$		9	0	0			
32	$\frac{0}{0}$	PASLAR N. (BUL)	P1	P2	P3	32		
	$\frac{0}{0}$		0	0	0			
33	$\frac{3}{5}$	MARSAGISHVILI Dato (GEO)	P1	P2	P3	33		
	$\frac{3}{5}$		5	0	0			
34	$\frac{4}{8}$	KUDIAMAGOMEDOV S. (RUS)	P1	P2	P3	34		
	$\frac{4}{8}$		8	0	0			
35	$\frac{0}{0}$	ABOU JAOUDE A. (BRA)	P1	P2	P3	35		
	$\frac{0}{0}$		0	0	0			
36	$\frac{4}{8}$	LASHGARI E. (IRI)	P1	P2	P3	36		
	$\frac{4}{8}$		8	0	0			
37	$\frac{0}{0}$	MARTINEZ IBARGUEN J. (COL)	P1	P2	P3	37		
	$\frac{0}{0}$		0	0	0			



Feuille de compétition / Competition Sheet

Sitetalk Wrestling World Championships

STYLE : FS 84 kg



Classement

Cl	Pays	Nom
1	UKR	ALDATOV Ibragim
2	CUB	SALAS PEREZ Reineris
3	HUN	VEREB Istvan
3	IRI	LASHGARI Ehsan Naser
5	BLR	GAIDAROV Murad
5	ESP	FRIEV NASKIDAEVA Talmuraz
7	GER	SEREGELYI Georg Gabriel
8	MGL	ORGODOL Uitumen
9	TUR	BOKE Serdar
10	GEO	MARSAGISHVILI Dato
11	ARM	MURTAZALIEV Musa
12	SUI	RIESEN Marco Lukas
13	POL	BALAWENDER Maciej Michal
14	USA	GAVIN Keith Michael
15	RUS	KUDJAMAGOMEDOV Shamil
16	UZB	SOKHIEV Zaurbek
17	AZE	GOSTIEV Alexander Taymurazovic
18	ROU	STEFAN Gheorghita
19	CHN	ZHANG Feng
20	IND	KUMAR Pawan

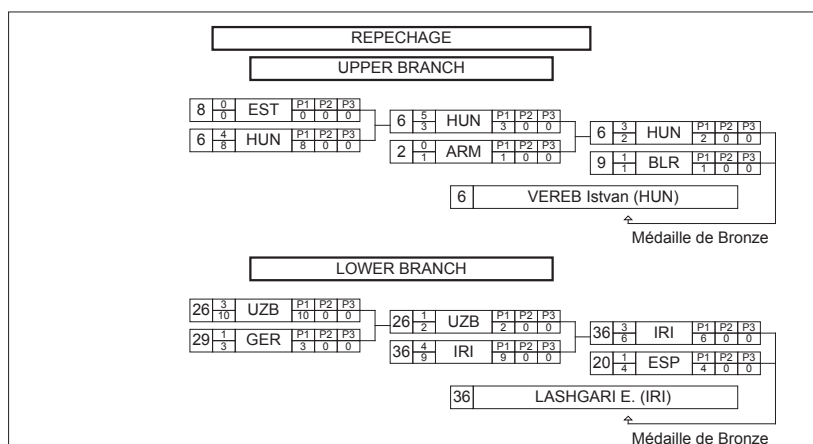

**Classement****Sitetalk Wrestling World Championships**

STYLE : FS 84 kg

**1 - Or / Gold**

ALDATOV Ibragim

2 - Argent / Silver

SALAS PEREZ Reineris

3 - Bronze

VEREB Istvan

LASHGARI Ehsan Naser

Classement	Nom - Name	Pays - Country
1	ALDATOV Ibragim	UKR
2	SALAS PEREZ R.	CUB
3	VEREB Istvan	HUN
3	LASHGARI E.	IRI
5	GAIDAROV Murad	BLR
5	FRIEV NASKIDAEVA T.	ESP
7	SEREGELYI G.	GER
8	ORGODOL Uitumen	MGL
9	BOKE Serdar	TUR
10	MARSAGISHVILI Dato	GEO
11	MURTAZALIEV Musa	ARM
12	RIESEN Marco Lukas	SUI
13	BALAWENDER M.	POL
14	GAVIN Keith Michael	USA
15	KUDIAMAGOMEDOV S.	RUS
16	SOKHIEV Zaurbek	UZB
17	GOSTIEV A.	AZE
18	STEFAN Gheorghita	ROU
19	ZHANG Feng	CHN
20	KUMAR Pawan	IND
21	TAGZIEV Tamerlan	CAN
22	IANULOV Piotr	MDA
23	KAKHIDZE Aslan	KAZ
24	XENIDIS Timofei	GRE
25	TSOTSELASHVILI M.	ISR
26	PEREZ SOSA L.	DOM
27	ZVIRBULIS Armands	LAT
28	LEE Jae-Sung	KOR
29	DIAZ ROBERTTI J.	VEN
30	BOGDANOV Dejan	MKD



Classement

Sitetalk Wrestling World Championships

STYLE : FS 84 kg



Classement	Nom - Name	Pays - Country
31	ESPINAL J.	PUR
32	PASLAR N.	BUL
33	MATSUMOTO Shinya	JPN
33	KELVIN Joseph	NZL
33	ABOU JAOUDE Antoine	BRA
33	MARTINEZ IBARGUEN J.	COL
37	SOLTRUK Jevgeni	EST



Feuille de compétition / Competition Sheet

Sitetalk Wrestling World Championships

STYLE : FS 96 kg



Classement

Cl	Pays	Nom
1	IRI	YAZDANY reza
2	AZE	GAZYUMOV Khetag
3	RUS	BOLTUKAEV Anzor
3	UKR	OLIINYK Pavlo
5	KGZ	KRUPNYAKOV Alexey
5	GEO	KERASHVILI Dato
7	POL	SKASKIEWICZ Kamil Stanislaw
8	JPN	YAMAGUCHI Takeshi
9	MDA	CEBAN Nicolai
10	ALB	SHALA Egzon
11	BLR	YANKOUSKI Ivan
12	IND	KADAYAN Satywart
13	GRE	TSIKOVANI Micheil
14	SVK	JALLOVIAR Jozef
15	LAT	LAGODSKIS Imants
16	KAZ	TIGIYEV Taimuraz
17	BUL	ILIEV Lyuben Borisov
18	CAN	SANDHU Manjot
19	TUR	YILDIRIM Riza Ziyaettin
20	GER	HARTH William

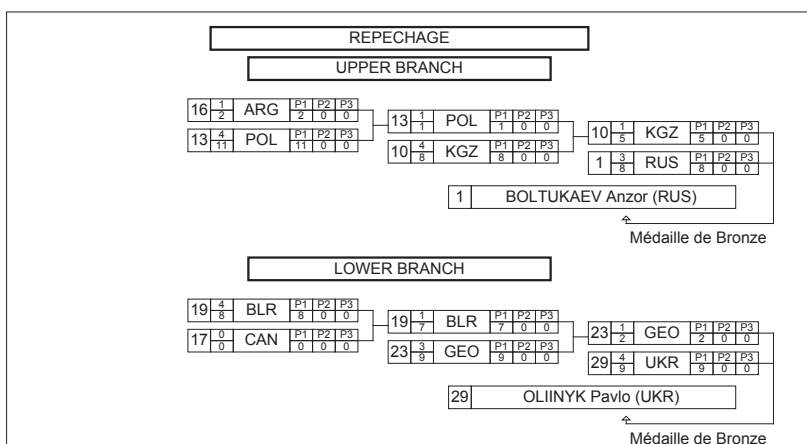

**Classement****Sitetalk Wrestling World Championships**

STYLE : FS 96 kg

1 - Or / Gold

YAZDANY reza

2 - Argent / Silver

GAZYUMOV Khetag

3 - Bronze

BOLTUKAEV Anzor

OLIINYK Pavlo

Classement	Nom - Name	Pays - Country
1	YAZDANY reza	IRI
2	GAZYUMOV Khetag	AZE
3	BOLTUKAEV Anzor	RUS
3	OLIINYK Pavlo	UKR
5	KRUPNYAKOV Alexey	KGZ
5	KERASHVILI Dato	GEO
7	SKASKIEWICZ K.	POL
8	YAMAGUCHI Takeshi	JPN
9	CEBAN Nicolai	MDA
10	SHALA Egzon	ALB
11	YANKOUSKI Ivan	BLR
12	KADAYAN Satywart	IND
13	TSIKOVANI Micheil	GRE
14	JALOVIAR Jozef	SVK
15	LAGODSKIS Imants	LAT
16	TIGIYEV Taimuraz	KAZ
17	ILIEV L.	BUL
18	SANDHU Manjot	CAN
19	YILDIRIM R.	TUR
20	HARTH William	GER
21	ZHANG Xueyi	CHN
22	MAIER Y.	ARG
23	KIM Jaegang	KOR
24	SZMIK Attila	HUN
25	BERGMAN J.	USA
26	YENOKYAN Edgar	ARM
27	GONZALEZ ALVAREZ J.	VEN
28	MANEA Michael	ROU
28	CHOTAS Bratislav	CZE
28	IZIDORO BITTENCOURT J.	BRA



Classement

Sitetalk Wrestling World Championships

STYLE : FS 96 kg



Classement	Nom - Name	Pays - Country
31	SIMAS Asaciovas	LTU
31	DORJKHAND K.	MGL
33	MADASING ACHCHILLAGE G.	SRI

SITETALK WRESTLING WORLD CHAMPIONSHIPS



BUDAPEST (HUN)

2013-09-16 - 2013-09-22 2013

Résultats - Results

Lutte Féminine - Female-Wrestling



**Liste des arbitres / Referee list****Sitetalk Wrestling World Championships**

N°	Licence	Pays Country	Nom - Last Name	Prénom - First Name
	4675	AZE	JAFAROV	Azhdar
	4037	AZE	SHARIFOV	Hijran
	4696	BLR	BREL	Ihar
		BRA	CONCALVES	Eduardo
	2214	BUL	ALEXANDROV	Levon
		BUL	GOCHEV	Miroslav
	4633	BUL	GUETZOV	Valentin Dotchev
	3106	BUL	KOSTADINOV	Iantcho
		CAN	MACKAY	Lee
	4308	CHN	SUN	Jian
	3291	CHN	ZHANG	Xia
	2829	CRO	OCIC	Zvonko
	3364	CRO	PETANJEK	Davor
		CUB	MOLINA	Orestes
		CUB	RODRIGUEZ	Manuel
	4828	CZE	SCHEINER	Vaclav
		DEN	ATAY ZEYNEL	Lutfu
	4097	EGY	MOUSTAFA	Ibrahim Adel
	4177	ESP	GARCIA	Carlos
	2082	FIN	VEHVILÄ„INEN	Pertti
	2546	FRA	LEGLEUT	RÃ©gine
		FRA	MENU HRISTOV	Celine
	2513	GEO	MACHAIDZE	Edisher
		GER	MANZ	Uwe
		GRE	MIGIPI	Anastasia
	4357	HUN	BACSA	PÃ©ter
	3456	HUN	PÃ©TERI	LÃ©szlÃ© ³
	3051	IRI	RAMEZAN NEJAD	Ramezan Ali
		IRI	TALEBI	Bahman
	4112	IRQ	QASSIM	Ali
	4670	ISR	SHMUELY	Aviram
	4356	ITA	DÃ©ZSA	Edit
		ITA	MASI	Marco
	3218	JPN	ASHIDA	Takaharu
	4702	JPN	OKIYAMA	Isao
		JPN	SAITO	Osamu
	4697	KAZ	JAXYKULOV	Bakhytzhan
	3348	KGZ	AHMETOV	Meyrambek
	3349	KGZ	KULMATOV	Kochkor

**Liste des arbitres / Referee list****Sitetalk Wrestling World Championships**

N°	Licence	Pays Country	Nom - Last Name	Prénom - First Name
		KOR	CHUNG	Tong Kun
	2385	MAR	MOCHAFFAA	Noreddine
	4362	MGL	TUMURBAATAR	Baatar
	5034	NED	ABDOELAEV	Edmar
	3077	POL	BRUDZINSKI	Grzegorz
	3359	POL	LEBKOWSKI	Karol
	4150	ROU	GYARMATI	Ferenc
	2541	ROU	LAZAR	Ovidiu
	4729	RUS	ARUSTAMYAN	Noravard
	3749	RUS	KRIKOV	Andrey
	3267	RUS	NOVAKOVSKIY	Sergey
		SAM	VILLET	Charles
	3408	SLO	SERNEK	Stanislav
	4386	SVK	VOJKOVIC	Miroslav
		SWZ	PUTALLAZ	Alain
		TPE	JANG	Tsong Rong
	3520	TUR	CICIOGLU	Halil Ibrahim
	4433	TUR	SEN	Levent
	3623	TUR	YUCEL	Sadettin
	4192	USA	DAVIS	Stacey
	3924	USA	ERRETT	Zachary David
		USA	GOESSEL	Casey
		USA	JULIAN	Sam
	3284	UZB	GULAMOV	Tokhir
		UZB	KONSTANTIN	Mikhailov

Nombre d'arbitres - Number of Referee

64









Liste des nations / Countries List

Sitetalk Wrestling World Championships



STYLE FW

Pays - Country

	AFRIQUE DU SUD	RSA
	ALLEMAGNE	GER
	ARGENTINE	ARG
	AUTRICHE	AUT
	AZERBAIDJAN	AZE
	BELARUS	BLR
	BRESIL	BRA
	BULGARIE	BUL
	CAMEROUN	CMR
	CANADA	CAN
	CHINE	CHN
	COLOMBIA	COL
	COREE	KOR
	COREE RDP	PRK
	CUBA	CUB
	EGYPTE	EGY
	ESPAGNE	ESP
	ESTONIE	EST
	FRANCE	FRA
	GRANDE BRETAGNE	GBR
	GREECE	GRE
	HONGRIE	HUN
	INDIA	IND
	ISRAEL	ISR
	ITALIE	ITA
	JAPON	JPN
	KAZAKHSTAN	KAZ
	KIRGIZSTAN	KGZ
	LETONIE	LAT
	MEXICO	MEX
	MOLDAVIE	MDA
	MONGOLIE	MGL
	NOUVELLE-ZELANDE	NZL
	OUZBEKISTAN	UZB
	PEROU	PER
	POLOGNE	POL
	ROUMANIE	ROU
	RUSSIE	RUS
	SENEGAL	SEN
	SUEDE	SWE
	TAIPEI CHINESE	TPE
	TCHEQUE REP.	CZE
	TUNISIE	TUN
	TURQUIE	TUR
	UKRAINE	UKR
	UNITED STATES	USA
	VENEZUELA	VEN
	VIETNAM	VIE



Liste des nations / Countries List

Sitetalk Wrestling World Championships

STYLE FW



Nombre de nations - Number of Countries 48

**Nombre d'engagés par nation / Number of Entries By Country****Sitetalk Wrestling World Championships****STYLE FW**

Pays - Country	48 KG	51 KG	55 KG	59 KG	63 KG	67 KG	72 KG	TOTAL
PRK	1	1	1					3
ROU	1		1	1		1		4
RSA		1			1			2
RUS	1	1	1	1	1	1	1	7
SEN		1			1			2
SWE			1		1		1	3
TPE				1		1		2
TUN			1	1				2
TUR	1	1	1		1	1	1	6
UKR	1	1	1	1	1	1	1	7
USA	1	1	1	1	1	1	1	7
UZB			1					1
VEN	1	1		1	1		1	5
VIE	1	1	1	1	1			5
TOTAL	29	23	28	25	28	24	25	182

Nombre de nations - Number of Countries **48**



Liste des Engagés par pays / Entry-List By Country

Sitotalk Wrestling World Championships



STYLE FW

ARGENTINA (ARG)

Entraîneur / Coach :	LEON, Erik
Lutteuse(s) / Wrestler(s) :	
48 kg	BERMUDEZ, Patricia Alejandra
67 kg	VAZQUEZ, Luz Clara

AUSTRIA (AUT)

Chef de délégation / Team Leader :	HELMDACH, JÄrg
Entraîneur / Coach :	HELMDACH, JÄrg
Kiné / Medical Staff :	KLAUS, Erich
Lutteuse(s) / Wrestler(s) :	
59 kg	RIEGLER, Martina
63 kg	RAFFLER, Laura
72 kg	GASTL, Marina

AZERBAIJAN (AZE)

Chef de délégation / Team Leader :	EYVAZOV, Tofig RZAYEV, Yashar
Entraîneur / Coach :	AGHAYEV, Aslan KONOREV, Konstantin MAMMADOV, Yagub
Médecin / Medical Staff :	ALIYEV, Rauf
Kiné / Medical Staff :	ISMAYILOV, Seymur
Lutteuse(s) / Wrestler(s) :	
48 kg	DOROGAN, Anzhela
59 kg	RATKEVICH, Yuliya
63 kg	NETREBA, Irina Petrovna
67 kg	ZUTOVA, Gozal

BELARUS (BLR)

Chef de délégation / Team Leader :	KAZAUSKI, Aliaksandr MEDVED, Aleksandr
Entraîneur / Coach :	CHANKO, Ivan SMAL, Siarhei ZAITSEU, Artur RAIKHLIN, Aleh SHUBAYEU, Zhumatai PANSTWA, Schengen



Liste des Engagés par pays / Entry-List By Country

Sitetalk Wrestling World Championships



STYLE FW

	SCHENGENER, Staaten
	SENGENO, VALSTYBES
	YERMAK, Anatoli
	MURZINKOU, Valiantsin
Médecin / Medical Staff :	YAKAULEU, Aliaksandr
	ZHUKOUSKI, Aliaksandr
Kiné / Medical Staff :	MIKHAILOUSKI, Aliaksandr
	HASPADARYK, Aliaksei
Lutteuse(s) / Wrestler(s) :	
48 kg	RYZHOVA, Alina
51 kg	KURACHKINA, Iryna
55 kg	HANCHAR YANUSHKEVICH , Katsiaryna
59 kg	MIKHALKOVA, Nadzeya
63 kg	MAMASHUK, Maria
67 kg	LEUCHANKA, Halina
72 kg	MARZALIUK, Vasilisa

BRAZIL (BRA)

Chef de délégation / Team Leader :	LEITAO, Roberto
Entraîneur / Coach :	PEREZ, Pedro
Lutteuse(s) / Wrestler(s) :	
59 kg	SOUZA DA SILVA, Joice
63 kg	OLIVEIRA, Lais
67 kg	DE OLIVEIRA, Gilda Maria
72 kg	DA SILVA FERREIRA, Aline

BULGARIA (BUL)

Entraîneur / Coach :	BARZAKOV, Serafim
	MANOLOV, Filip
	MIN CHEV, Nikolaz Georgiev
	MIN CHEV, Nikolay Georgiev
	KARADUSHEV, Georgi
	SOFIADI, Rahmat
	COBILEAN, Constantin
Médecin / Medical Staff :	BORISOV, Boris
	STRUGAROV, Stefan
Kiné / Medical Staff :	TONCHEV, Marin
	BORISOV, Emil



Liste des Engagés par pays / Entry-List By Country

Sitetalk Wrestling World Championships

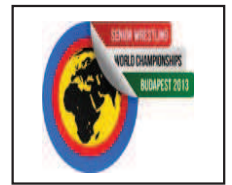

STYLE FW

Lutteuse(s) / Wrestler(s) :

48 kg	YANKOVA, Elitsa Atanasova
51 kg	TRANDEVA, Valya Tihomirova
55 kg	HRISTOVA, Mimi Nikolova
59 kg	YUSEIN, Taybe Mustafa
63 kg	BOBEVA, Viktoria Ivanova
67 kg	VASEVA, Elina Lyubchova

CAMEROON (CMR)

Chef de délégation / Team Leader : SARR, Ibrahima

Lutteuse(s) / Wrestler(s) :

48 kg	MUAMBO, Rebecca Ndolo
72 kg	ALI, Annabel Laure

CANADA (CAN)

Chef de délégation / Team Leader : HOGARTH, Bill

Entraîneur / Coach : VIERLING, Leigh
CALDER, Marty
RAGUSA, Paul
VERBEEK, Tonya

Médecin / Medical Staff : BUDWAL, Surinder
CLEARY, Victoria

Kiné / Medical Staff : TKACH, Rick

Lutteuse(s) / Wrestler(s) :

48 kg	KRAMBLE, Natasha Irene Vera
51 kg	MACDONALD BONDY, Jessica Anne Marie
55 kg	GALLAYS, Jillian Alice
59 kg	STONE, Braxton Rei
63 kg	BOUCHARD, Justine Angelle
67 kg	ANAKA, Stacie
72 kg	WIEBE, Erica Elizabeth

CHINA (CHN)

Chef de délégation / Team Leader : XUE, Lian

DONG, Shenghui

Entraîneur / Coach : ZHANG, Haojie
XU, Kuiyuan
LU, Hai



Liste des Engagés par pays / Entry-List By Country

Sitetalk Wrestling World Championships



STYLE FW

Lutteuse(s) / Wrestler(s) :

48 kg	XU, Cheng
51 kg	SUN, Yanan
55 kg	ZHONG, Xuechun
59 kg	YANG, Chen
63 kg	XILUOZHUOMA, XI
67 kg	ZHOU, Zhangting
72 kg	ZHANG, Fengliu

COLOMBIA (COL)

Entraîneur / Coach : GUTIERREZ, David

Médecin / Medical Staff : CHICA, Catalina
RIOS, Fernando

Lutteuse(s) / Wrestler(s) :

48 kg	CASTILLO HIDALGO, Carolina
59 kg	CANON CARVAJAL, Sayury Yormary
63 kg	RENTERIA CASTILLO, Jackeline
67 kg	IZQUIERDO MENDEZ, Leidy Marcela
72 kg	OLAYA GUTIERREZ, Andrea Carolina

CUBA (CUB)

Chef de délégation / Team Leader : TELLEZ, Eduardo Perez

Entraîneur / Coach : CLARK, Elio Garraway

Médecin / Medical Staff : CHACON, Siggilfredo Acosta

Lutteuse(s) / Wrestler(s) :

59 kg	ESTORNELL ELIZASTIGUE, Yaquelin
63 kg	VIDIAUX LOPEZ, Katerina
72 kg	HECHAVARRIA MEDINA, Lisset

CZECH REPUBLIC (CZE)

Chef de délégation / Team Leader : VARGA, Ervin

Entraîneur / Coach : HEMZA, Milan

Lutteuse(s) / Wrestler(s) :

55 kg	MARTINAKOVA, Lenka
-------	--------------------

EGYPT (EGY)

Chef de délégation / Team Leader : EL-HADAD, Hassan



Liste des Engagés par pays / Entry-List By Country

Sitetalk Wrestling World Championships



STYLE FW

Lutteuse(s) / Wrestler(s) :

63 kg FARG, Hayat
67 kg ANTER, Nadia

ESTONIA (EST)

Chef de délégation / Team Leader : PÄ--LLUSTE, Henn
Entraîneur / Coach : HAPOV, Aleksei
Médecin / Medical Staff : JAIRUS, Aleksander

Lutteuse(s) / Wrestler(s) :

72 kg MAE, Epp

FRANCE (FRA)

Entraîneur / Coach : GONZALES AGUILERA, Daniel
LEGRAND, David
Médecin / Medical Staff : AISENBERG, Charles

Lutteuse(s) / Wrestler(s) :

48 kg LESAFFRE, Melanie Lydie Sandra
55 kg BASSET, Aurelie
72 kg VESCAN, Cynthia Vanessa

GERMANY (GER)

Chef de délégation / Team Leader : ZAMANDURIDIS, Jannis

Entraîneur / Coach : FOCKEN, Georg
KOTHE, Michael
GHITA, Nicolae
LOES, Patrik
GALWAS, Waldemar
WALDERMAR, Galwas

Médecin / Medical Staff : TRAGESER, Steffen
GSTÄ--TTNER, Hans
KLOTZ, Christian

Kiné / Medical Staff : SCHRENKER, Klaus

Lutteuse(s) / Wrestler(s) :

48 kg SCHELLIN, Jaqueline saskia
51 kg HEMMER , Nina
55 kg HAUPTMANN, Nicole
67 kg FOCKEN, Aline
72 kg SELMAIER, Maria



Liste des Engagés par pays / Entry-List By Country

Sitetalk Wrestling World Championships



STYLE FW

GREAT BRITAIN (GBR)

Chef de délégation / Team Leader : MORLEY, Malcolm
Entraîneur / Coach : KHARYTONIUK, Analolef
Lutteuse(s) / Wrestler(s) :
48 kg STADNIK, Yana

GREECE (GRE)

Entraîneur / Coach : XENIDIS, Christoforos
Lutteuse(s) / Wrestler(s) :
55 kg PREVOLARAKI, Maria
63 kg PAPAVALASILEIOU, Agoro

HUNGARY (HUN)

Chef de délégation / Team Leader : MAROTHY, Istvan
Entraîneur / Coach : WOLLER, Akos
Médecin / Medical Staff : BAKANEK, Gyorgy
DR. TEMESI, Laszlo
Kiné / Medical Staff : HADI, Gergely
Lutteuse(s) / Wrestler(s) :
48 kg DENES, Mercedesz
51 kg KOROSI, Kitti Angela
55 kg BARKA, Emese
59 kg SASTIN, Marianna
63 kg SANDOR, Klaudia
67 kg GODO, Kitti
72 kg NEMETH, Zsanett

INDIA (IND)

Chef de délégation / Team Leader : YADAV, O.P.
Entraîneur / Coach : VINOD, Kumar
KUMAR, Virender
MESTVIRISHVILI, Vladimer
Médecin / Medical Staff : VIJAY, Vijay
VIKAS, Vikas
Kiné / Medical Staff : SHARMA, Rahul
Lutteuse(s) / Wrestler(s) :
48 kg DEVI, Nirmla



Liste des Engagés par pays / Entry-List By Country

Sitetalk Wrestling World Championships



STYLE FW

51 kg	-, Vinesh
55 kg	-, Pooja
59 kg	-, Geeta
63 kg	JAKHAR, Geetika
67 kg	KAUR, Navjot
72 kg	-, Jyoti

ISRAEL (ISR)

Chef de délégation / Team Leader : SHULMAN, Leonid

Entraîneur / Coach : ZILBERMAN, Victor

Lutteuse(s) / Wrestler(s) :

72 kg KRATYSH, Ilana

ITALY (ITA)

Chef de délégation / Team Leader : CAUDULLO, Antonino

Entraîneur / Coach : DELGADO SANTIAGO, Filiberto Alberto

Lutteuse(s) / Wrestler(s) :

48 kg FELICE, Silvia
63 kg DIANA, Maria
67 kg CANEVA, Dalma

JAPAN (JPN)

Chef de délégation / Team Leader : MARUYAMA, Hideji

HASE, Hiroshi
TANIOKA, Kuniko

Entraîneur / Coach : SAKAE, Kazuhito
YOSHIDA, Eikatsu
KINASE, Shigeo

SASAYAMA, Hideo
SAITO, Masashi

Médecin / Medical Staff : NAGAO, Shigeno

MASUJIMA, Atsushi
NAKAJIMA, Kohei

Kiné / Medical Staff : TAKAHASHI, Asuka

KAWASAKI, Atsushi

Lutteuse(s) / Wrestler(s) :

48 kg TOSAKA, Eri
51 kg MIYAHARA, Yu



Liste des Engagés par pays / Entry-List By Country

Sitetalk Wrestling World Championships



STYLE FW

55 kg	YOSHIDA, Saori
59 kg	ITO, Ayaka
63 kg	ICHO, Kaori
67 kg	DOSHO, Sara
72 kg	SUZUKI, Hiroe

KAZAKHSTAN (KAZ)

Chef de délégation / Team Leader :	UMRALIYEV, Ruslan
Entraîneur / Coach :	ZHOLAMANOV, Kuandyk AMANOV, Abutalip ABDRASHEV, Askar ONGGARBAIUY, Altay UNDEMESEV, Ungarbay
Médecin / Medical Staff :	KLIPAN, Andrey
Kiné / Medical Staff :	KLIPAN, Sairan

Lutteuse(s) / Wrestler(s) :

48 kg	AMANZHOL, Tatyana
51 kg	YAKHYAROVA, Zulfiya
55 kg	ISMAGULOVA, Aizhan
59 kg	KASSYMOVA, Ayaulym
63 kg	LARIONOVA, Yekaterina
67 kg	SYZDYKOVA, Elmira
72 kg	MANYUROVA, Guzel

KYRGYZSTAN (KGZ)

Chef de délégation / Team Leader :	USHAKOV, Vadim
Entraîneur / Coach :	IZABEKOV, Nurbek MUSAEV, Magomed IAKOVLEV, Budimir SIVTCEV, Ivan
Médecin / Medical Staff :	ALISHEVA, Baktygul

Lutteuse(s) / Wrestler(s) :

59 kg	TYNYBEKOVA, Aisuluu
-------	---------------------

LATVIA (LAT)

Chef de délégation / Team Leader :	URBANCIKS, Dzintars
Entraîneur / Coach :	FREIDENFELDS, Visvaldis

Lutteuse(s) / Wrestler(s) :



Liste des Engagés par pays / Entry-List By Country

Sitetalk Wrestling World Championships



STYLE FW

51 kg TJAPICO, Karalina
67 kg SKUJINA, Laura

MEXICO (MEX)

Lutteuse(s) / Wrestler(s) :

48 kg PEREDO, Laura
51 kg MARTINEZ, Wendy
55 kg VALENCIA, Jane

MOLDOVA (MDA)

Chef de délégation / Team Leader : PEICOV, Victor
Entraîneur / Coach : COBĂŢLEAN, Constantin

Lutteuse(s) / Wrestler(s) :

55 kg ESANU, Mariana
72 kg SAENKO, Svetlana

MONGOLIA (MGL)

Chef de délégation / Team Leader : DOLGORSUREN, Dagvadorj
Entraîneur / Coach : TUMENDEMBEREL, Sukhbaatar
ZEVEG, Duvchin
BUYANDELGER, Batbayar
Médecin / Medical Staff : CHULUUN, Nasanbat
Kiné / Medical Staff : MANDUUL, Tuvshintur
MYAGMARSUREN, Sarantsatsral

Lutteuse(s) / Wrestler(s) :

48 kg TSOGTBAZAR, Enkhjargal
51 kg ERDENECHIMEG, Sumiya
55 kg SUNDEV, Byambatseren
59 kg TUNGALAG, Munkhtuya
63 kg SORONZONBOLD, Battsetseg
67 kg OCHIRBAT, Nasanburmaa
72 kg OCHIRBAT, Burmaa

NEW ZEALAND (NZL)

Chef de délégation / Team Leader : GRAYLING, Mark
Kiné / Medical Staff : DAVIES, Andrea

Lutteuse(s) / Wrestler(s) :



Liste des Engagés par pays / Entry-List By Country

Sitetalk Wrestling World Championships



STYLE FW

55 kg

POURI-LANE, Korja Maxine

NORTH KOREA (PRK)

Chef de délégation / Team Leader : KIM, Il

Entraîneur / Coach : RI, Won Il

Lutteuse(s) / Wrestler(s) :

48 kg PAK, Yong Mi

51 kg SO, Sim Hyang

55 kg HAN, Kum Ok

PERU (PER)

Lutteuse(s) / Wrestler(s) :

48 kg MALLQUI PECHE, Thalia Jihann

POLAND (POL)

Chef de délégation / Team Leader : WRONSKI, Andrzej
ZBIGNIEW, Grudzien
ORDACK, Artur

Entraîneur / Coach : OLENCZYN, Krzysztof
LOBAS, Igor
ABDUSALAMOV, Yusup

Médecin / Medical Staff : JAKUBOWSKI, Adam

Kiné / Medical Staff : MARCIN, Krzysztozek

Lutteuse(s) / Wrestler(s) :

48 kg LUKASIAK, Anna

51 kg ZASINA, Roksana Marta

55 kg KRAWCZYK, Katarzyna

59 kg ZWIRYDOWSKA, Anna Teresa

63 kg MICHALIK, Monika Ewa

67 kg OSOCKA, Daria Urszula

ROMANIA (ROU)

Chef de délégation / Team Leader : RAZVAN LUCIAN, Pircalabu

Entraîneur / Coach : CORNEA, Cornel

Lutteuse(s) / Wrestler(s) :

48 kg LINGURARU, Madalina



Liste des Engagés par pays / Entry-List By Country

Sitetalk Wrestling World Championships



STYLE FW

55 kg	PAVAL, Ana Maria
59 kg	PAIC, Georgiana Narcisa
67 kg	POPESCU, Adina Elena

RUSSIA (RUS)

Chef de délégation / Team Leader :	FADZAEV, Arsen ALEXANDRIDIS, Christakis
Entraîneur / Coach :	MOLONOV, Maksim SMIRNOVA, Natalia GERCHEGLO, Dmitry PODLIVAEV, Boris TSEBOEV, Vladislav MAGONEDOV, Khadzimurad BAGAEV, Slavik UMAROV, Zhaa SAZHIDOV, Sazhid TEDEEV, Dzambolat ZIRATOV, Rasid MARGIEV, Anatolii MINTULAEV, Oikhuzur RASHIDOV, Shamil MAGOMEDOV, Magomed
Médecin / Medical Staff :	TEBIEV, Umar
Kiné / Medical Staff :	KOROLIOV, Evgeny BESTAEV, Gvineriy

Lutteuse(s) / Wrestler(s) :

48 kg	VOSTRIKOVA, Elena
51 kg	KRASNOVA, Ekatarina
55 kg	KOBLOVA, Valeriia
59 kg	LIPATOVA, Svetlana
63 kg	BRATCHIKOVA, Anastasia
67 kg	KUKSINA, Natalia
72 kg	VOROBEVA, Natalia

SENEGAL (SEN)

Chef de délégation / Team Leader :	SARR, Ibrahima
Entraîneur / Coach :	MIN CHEV, Nikolay Georgiev
Lutteuse(s) / Wrestler(s) :	
51 kg	SAMBOU, Isabelle



Liste des Engagés par pays / Entry-List By Country

Sitetalk Wrestling World Championships



STYLE FW

63 kg

SAMBOU, Anta

SOUTH AFRICA (RSA)

Chef de délégation / Team Leader : COETZEE, Nico

Lutteuse(s) / Wrestler(s) :

51 kg

MADI, Mpho

63 kg

GERINGER, Zumicke

SOUTH KOREA (KOR)

Chef de délégation / Team Leader : KIM, Kyunghwan

CHUNG, Nakkyu

Entraîneur / Coach :

KIM, Eunyou

KIM, Euikon

Médecin / Medical Staff :

KIM, Deokwon

Kiné / Medical Staff :

KIM, Youngil

Lutteuse(s) / Wrestler(s) :

48 kg

KANG, Eunju

51 kg

KIM , Hyung-Joo

55 kg

UM , Jieun

72 kg

HEO, Namju

SPAIN (ESP)

Chef de délégation / Team Leader : IGLESIAS, Francisco Javier

Entraîneur / Coach :

BARCIA, Francisco

Lutteuse(s) / Wrestler(s) :

59 kg

SANCHEZ RAMIS, Karima

63 kg

GARCIA GARRIDO, Irene

SWEDEN (SWE)

Chef de délégation / Team Leader : PERSSON, Christer

Entraîneur / Coach :

MAGNUSSON, Patrik

Kiné / Medical Staff :

GANNBY, Ingemar

Lutteuse(s) / Wrestler(s) :

55 kg

MATTSSON, Sofia Magdalena

63 kg

JOHANSSON, Henna Katarina

72 kg

FRANSSON, Anna Jenny Eva Maria



Liste des Engagés par pays / Entry-List By Country

Sitetalk Wrestling World Championships

STYLE FW



TAIPEI CHINESE (TPE)

Lutteuse(s) / Wrestler(s) :

59 kg	HOU, Min-wen
67 kg	CHEN, Wen-Ling

TUNISIA (TUN)

Chef de délégation / Team Leader : BACH HAMBBA, Amor

Entraîneur / Coach : SGHAIER, Zouhaier

Lutteuse(s) / Wrestler(s) :

55 kg	AMRI, Marwa
59 kg	RIABI, Hela

TURKEY (TUR)

Chef de délégation / Team Leader : YERLIKAYA, Hamza
AKBAS, Oktay
YASAR, Hasan Huseyin
YERLIKAYA, Hamza

Lutteuse(s) / Wrestler(s) :

48 kg	DEMIRHAN, Evin
51 kg	KEBIC, Burcu
55 kg	GÄ'¼N, Bediha
63 kg	TOSUN, Buse
67 kg	DURUKAN, Gamze
72 kg	ADAR, Yaemin

UKRAINE (UKR)

Chef de délégation / Team Leader : KHARENKO, Dina

Entraîneur / Coach : BAZYLIUK, Iaroslav
YEVONOV, Volodymyr
DANKO, Grygorii

Médecin / Medical Staff : SHVANGYRADZE, Merab

Kiné / Medical Staff : BORODKOV, Sergiy

Lutteuse(s) / Wrestler(s) :

48 kg	LIVACH, Mariya
51 kg	BLAHINYA, Yuliya
55 kg	HUSYAK, Iryna
59 kg	LAVRENUCHUK, Tetyana



Liste des Engagés par pays / Entry-List By Country

Sitetalk Wrestling World Championships



STYLE FW

63 kg	VASYLENKO, Ganna
67 kg	STADNIK-MAKHYNIA, Alina
72 kg	MOSPAN, Maryna

UNITED STATES (USA)

Chef de délégation / Team Leader :	KIEBLESZ, Paul STEINER, Terry KELLEY, Christina
Entraîneur / Coach :	CONTI, Alex BLACK, Kevin
Médecin / Medical Staff :	ROBERTO, Fred BOSWELL, Randy WHIREN, Tony RICE, Erika DR. FELDMANN, Bernie
Kiné / Medical Staff :	POITIER, Cyrus

Lutteuse(s) / Wrestler(s) :

48 kg	LAMPE, Alyssa Rae Nicole
51 kg	ANTHONY, Victoria Lacey
55 kg	MAROULIS, Helen Louise
59 kg	RAGAN, Allison Mackenzie
63 kg	PIROZHKOVA, Elena
67 kg	CARLSON, Veronica B
72 kg	GRAY, Adeline Maria

UZBEKISTAN (UZB)

Entraîneur / Coach :	KAGARMANOV, Akhmet
Médecin / Medical Staff :	ABAEVA, Elena
Lutteuse(s) / Wrestler(s) :	
55 kg	SHAKIROVA, Lilyia

VENEZUELA (VEN)

Chef de délégation / Team Leader :	VALBUANA, Norman
Entraîneur / Coach :	DIAZ, Jose VAZQUEZ, Alberto DIAZ, Edward
Médecin / Medical Staff :	VASQUEZ MAIZO, Jhony Sneidel
Lutteuse(s) / Wrestler(s) :	



Liste des Engagés par pays / Entry-List By Country

Sitetalk Wrestling World Championships

STYLE FW



48 kg	CARIPA CASTILLO, Mayelis Yesenia
51 kg	RIVAS, Aguis
59 kg	HENRIQUEZ HERNANDEZ, Mirna Carolina
63 kg	GRIMAN HERRERA, Nathaly Josefina
72 kg	WEFFER GUANIPA, Jaramit Leonor

VIETNAM (VIE)

Chef de délégation / Team Leader : NGUYEN, The Long

Entraîneur / Coach :
DOI, Dang Hy
TRAN, Van Son

Lutteuse(s) / Wrestler(s) :

48 kg	VU, Thi Hang
51 kg	NGUYEN, Thi Lua
55 kg	PHAM , Thi Hue
59 kg	PHAM, Thi Loan
63 kg	NGUYEN, Thi



Feuille de compétition / Competition Sheet

Sitetalk Wrestling World Championships



STYLE : FW 48 kg

QUALIFICATION				1/8 FINALE				1/4 FINALE				1/2 FINALE				FINALE																																
1		XU Cheng (CHN)						1	1	CHN	P1	P2	P3					2	5	VEN	P1	P2	P3					2	4	VEN	P1	P2	P3					25	0	VEN	P1	P2	P3					
								6	6	CHN	6	0	0						8	8	VEN	8	0	0					6	6	VEN	6	0	0					0	0	VEN	0	0	0				
2		CARIPA CASTILLO M. (VEN)						2	4	VEN	P1	P2	P3					4	0	MGL	P1	P2	P3					2	0	VEN	P1	P2	P3					0	0	VEN	P1	P2	P3					
								10	10	VEN	10	0	0					9	9	MGL	9	0	0					0	0	VEN	0	0	0					0	0	VEN	0	0	0					
3		MUAMBO R. (CMR)						3	1	CMR	P1	P2	P3					4	0	MGL	P1	P2	P3					4	4	MGL	4	0	0					0	0	VEN	0	0	0					
								1	1	CMR	1	0	0					9	9	MGL	9	0	0					4	4	MGL	4	0	0					0	0	VEN	0	0	0					
4	4	TSOGTBAZAR E. (MGL)	P1	P2	P3			4	4	MGL	P1	P2	P3					10	0	POL	P1	P2	P3					0	0	VEN	P1	P2	P3															
								7	7	MGL	7	0	0					10	0	POL	P1	P2	P3					0	0	VEN	P1	P2	P3					0	0	VEN	P1	P2	P3					
5	1	LIVACH Mariya (UKR)	P1	P2	P3			4	7	MGL	P1	P2	P3					10	3	POL	P1	P2	P3					0	0	VEN	P1	P2	P3					0	0	VEN	P1	P2	P3					
								2	2	UKR	2	0	0					10	7	POL	10	0	0					0	0	VEN	0	0	0					0	0	VEN	0	0	0					
6	1	RYZHOVA Alina (BLR)	P1	P2	P3			7	1	PER	P1	P2	P3					10	3	POL	P1	P2	P3					0	0	VEN	P1	P2	P3					0	0	VEN	P1	P2	P3					
								10	10	PER	10	0	0					10	7	POL	10	0	0					0	0	VEN	0	0	0					0	0	VEN	0	0	0					
7	3	MALLQUI PECHE T. (PER)	P1	P2	P3			7	10	PER	P1	P2	P3					10	3	POL	P1	P2	P3					0	0	VEN	P1	P2	P3					0	0	VEN	P1	P2	P3					
								9	9	PER	9	0	0					10	7	POL	10	0	0					0	0	VEN	0	0	0					0	0	VEN	0	0	0					
8	0	VU Thi Hang (VIE)	P1	P2	P3			9	3	PRK	P1	P2	P3					10	3	POL	P1	P2	P3					0	0	VEN	P1	P2	P3					0	0	VEN	P1	P2	P3					
								12	12	PRK	12	0	0					10	7	POL	10	0	0					0	0	VEN	0	0	0					0	0	VEN	0	0	0					
9	5	PAK Yong Mi (PRK)	P1	P2	P3			9	12	PRK	P1	P2	P3					10	3	POL	P1	P2	P3					0	0	VEN	P1	P2	P3					0	0	VEN	P1	P2	P3					
								4	4	PRK	4	0	0					10	7	POL	10	0	0					0	0	VEN	0	0	0					0	0	VEN	0	0	0					
10	4	LUKASIAK Anna (POL)	P1	P2	P3			10	4	POL	P1	P2	P3					10	3	POL	P1	P2	P3					0	0	VEN	P1	P2	P3					0	0	VEN	P1	P2	P3					
								11	11	POL	11	0	0					10	7	POL	10	0	0					0	0	VEN	0	0	0					0	0	VEN	0	0	0					
11	0	YANKOVA E. (BUL)	P1	P2	P3			10	11	POL	P1	P2	P3					10	3	POL	P1	P2	P3					0	0	VEN	P1	P2	P3					0	0	VEN	P1	P2	P3					
								0	0	BUL	0	0	0					10	7	POL	10	0	0					0	0	VEN	0	0	0					0	0	VEN	0	0	0					
12	5	STADNIK Yana (GBR)	P1	P2	P3			12	1	GBR	P1	P2	P3					10	3	POL	P1	P2	P3					0	0	VEN	P1	P2	P3					0	0	VEN	P1	P2	P3					
								6	6	GBR	6	0	0					10	7	POL	10	0	0					0	0	VEN	0	0	0					0	0	VEN	0	0	0					
13	0	DOROGAN Anzhela (AZE)	P1	P2	P3			12	4	GBR	P1	P2	P3					10	3	POL	P1	P2	P3					0	0	VEN	P1	P2	P3					0	0	VEN	P1	P2	P3					
								2	2	AZE	2	0	0					10	7	POL	10	0	0					0	0	VEN	0	0	0					0	0	VEN	0	0	0					
14	3	VOSTRIKOVA Elena (RUS)	P1	P2	P3			14	3	RUS	P1	P2	P3					10	3	POL	P1	P2	P3					0	0	VEN	P1	P2	P3					0	0	VEN	P1	P2	P3					
								5	5	RUS	5	0	0					10	7	POL	10	0	0					0	0	VEN	0	0	0					0	0	VEN	0	0	0					
15	0	KRAMBLE N. (CAN)	P1	P2	P3			14	5	RUS	P1	P2	P3					10	3	POL	P1	P2	P3					0	0	VEN	P1	P2	P3					0	0	VEN	P1	P2	P3					
								6	6	CAN	6	0	0					10	7	POL	10	0	0					0	0	VEN	0	0	0					0	0	VEN	0	0	0					
16	3	CASTILLO HIDALGO C. (COL)	P1	P2	P3			16	1	COL	P1	P2	P3					10	3	POL	P1	P2	P3					0	0	VEN	P1	P2	P3					0	0	VEN	P1	P2	P3					
								2	2	COL	2	0	0					10	7	POL	10	0	0					0	0	VEN	0	0	0					0	0	VEN	0	0	0					
17	1	KANG Eunju (KOR)	P1	P2	P3			16	2	COL	P1	P2	P3					10	3	POL	P1	P2	P3					0	0	VEN	P1	P2	P3					0	0	VEN	P1	P2	P3					
								3	3	KOR	3	0	0					10	7	POL	10	0	0					0	0	VEN	0	0	0					0	0	VEN	0	0	0					
18	1	PEREDO Laura (MEX)	P1	P2	P3			19	3	FRA	P1	P2	P3					10	3	POL	P1	P2	P3					0	0	VEN	P1	P2	P3					0	0	VEN	P1	P2	P3					
								5	5	MEX	5	0	0					10	7	POL	10	0	0					0	0	VEN	0	0	0					0	0	VEN	0	0	0					
19	3	LESAFFRE M. (FRA)	P1	P2	P3			19	8	FRA	P1	P2	P3					10	3	POL	P1	P2	P3					0	0	VEN	P1	P2	P3					0	0	VEN	P1	P2	P3					
								7	7	FRA	7	0	0					10	7	POL	10	0	0					0	0	VEN	0	0	0					0	0	VEN	0	0	0					
20	3	FELICE Silvia (ITA)	P1	P2	P3			20	1	ITA	P1	P2	P3					10	3	POL	P1	P2	P3					0	0	VEN	P1	P2	P3					0	0	VEN	P1	P2	P3					
								3	3	ITA	3	0	0					10	7	POL	10	0	0					0	0	VEN	0	0	0					0	0	VEN	0	0	0					
21	1	SCHELLIN J. (GER)	P1	P2	P3			20	3	ITA	P1	P2	P3					10	3	POL	P1	P2	P3					0	0	VEN	P1	P2	P3					0	0	VEN	P1	P2	P3					
								5	5	GER	5	0	0					10	7	POL	10	0	0					0	0	VEN	0	0	0					0	0	VEN	0	0	0					
22	4	LAMPE A. (USA)	P1	P2	P3			22	0	USA	P1	P2	P3					10	3	POL	P1	P2	P3					0	0	VEN	P1	P2	P3					0	0	VEN	P1	P2	P3					
								0	0	USA	0	0	0					10	7	POL	10	0	0					0	0	VEN	0	0	0					0	0	VEN	0	0	0					
23	0	DEVI Nirmla (IND)	P1	P2	P3			23	0	IND	P1	P2	P3					10	3	POL	P1	P2	P3					0	0	VEN	P1	P2	P3					0	0	VEN	P1	P2	P3					
								0	0	IND	0	0	0					10	7	POL	10	0	0					0	0	VEN	0	0	0					0	0	VEN	0	0	0					

**Classement****Sitetalk Wrestling World Championships**

STYLE : FW 48 kg

**1 - Or / Gold**

TOSAKA Eri

2 - Argent / Silver

CARIPA CASTILLO Mayelis Yesenia

3 - Bronze

XU Cheng

LAMPE Alyssa Rae Nicole

Classement	Nom - Name	Pays - Country
1	TOSAKA Eri	JPN
2	CARIPA CASTILLO M.	VEN
3	XU Cheng	CHN
3	LAMPE A.	USA
5	LUKASIAK Anna	POL
5	LESAFFRE M.	FRA
7	AMANZHOL Tatyana	KAZ
8	PAK Yong Mi	PRK
9	TSOGTBAZAR E.	MGL
10	VOSTRIKOVA Elena	RUS
11	STADNIK Yana	GBR
12	BERMUDEZ P.	ARG
13	MALLQUI PECHE T.	PER
14	FELICE Silvia	ITA
15	CASTILLO HIDALGO C.	COL
16	SHELLIN J.	GER
17	PEREDO Laura	MEX
18	KANG Eunju	KOR
19	RYZHOVA Alina	BLR
20	LIVACH Mariya	UKR
21	MUAMBO R.	CMR
22	DOROGAN Anzhela	AZE
23	VU Thi Hang	VIE
23	DENES Mercedesz	HUN
25	KRAMBLE N.	CAN
26	YANKOVA E.	BUL
26	DEMIRHAN Evin	TUR
26	DEVI Nirmla	IND
29	LINGURARU Madalina	ROU



Feuille de compétition / Competition Sheet

Sitetalk Wrestling World Championships



STYLE : FW 51 kg

QUALIFICATION		1/8 FINALE		1/4 FINALE		1/2 FINALE		FINALE	
1	ANTHONY V. (USA)	1	5/8 USA	1	4/7 USA	1	0/6 USA	12	SUN Yanan (CHN)
2	TRANDEVA V. (BUL)	2	0/4 BUL	4	0/0 POL	7	0/0 MGL		
3	YAKHYAROVA Zulfiya (KAZ)	3	1/6 KAZ	6	1/8 PRK	7	5/2 MGL		
4	ZASINA R. (POL)	4	3/6 POL	7	3/10 MGL				
5	KIM Hyung-Joo (KOR)	5	1/3 KOR	8	0/2 VIE				
6	SO Sim Hyang (PRK)	6	4/10 PRK	9	1/3 GER				
7	ERDENECHIMEG S. (MGL)	7	5/6 MGL	11	1/2 UKR				
8	NGUYEN Thi Lua (VIE)	8	0/2 VIE	11	3/3 UKR				
9	HEMMER Nina (GER)	9	1/3 GER	12	4/10 CHN				
10	KOROSI K. (HUN)	10	0/0 KOROSI K. (HUN)	12	4/9 CHN				
11	BLAHINYA Yuliya (UKR)	11	3/3 BLAHINYA Yuliya (UKR)	14	1/2 BLR				
12	SUN Yanan (CHN)	12	4/9 SUN Yanan (CHN)	16	1/3 JPN				
13	KRASNOVA Ekatarina (RUS)	13	1/3 KRASNOVA Ekatarina (RUS)	18	4/8 CAN				
14	KURACHKINA Iryna (BLR)	14	4/12 KURACHKINA Iryna (BLR)	18	3/8 CAN				
15	KEBIC Burcu (TUR)	15	1/4 KEBIC Burcu (TUR)	21	3/6 SEN				
16	MIYAHARA Yu (JPN)	16	4/9 MIYAHARA Yu (JPN)	21	0/0 SEN				
17	RIVAS Aguis (VEN)	17	0/0 RIVAS Aguis (VEN)	23	1/3 IND				
18	MACDONALD BONDY J. (CAN)	18	4/5 MACDONALD BONDY J. (CAN)						
19	TJAPICO Karalina (LAT)	19	0/0 TJAPICO Karalina (LAT)						
20	MADI Mpho (RSA)	20	0/0 MADI Mpho (RSA)						
21	SAMBOU Isabelle (SEN)	21	4/8 SAMBOU Isabelle (SEN)						
22	MARTINEZ Wendy (MEX)	22	0/0 MARTINEZ Wendy (MEX)						
23	- Vinesh (IND)	23	4/7 - Vinesh (IND)						

12 SUN Yanan (CHN)

Classement

Cl	Pays	Nom
1	CHN	SUN Yanan
2	MGL	ERDENECHIMEG Sumiya
3	PRK	SO Sim Hyang
3	CAN	MACDONALD BONDY Jessica Anne
5	UKR	BLAHINYA Yuliya
5	USA	ANTHONY Victoria Lacey
7	BLR	KURACHKINA Iryna
8	SEN	SAMBOU Isabelle
9	JPN	MIYAHARA Yu
10	IND	- Vinesh
11	POL	ZASINA Roksana Marta
12	RUS	KRASNOVA Ekatarina
13	KAZ	YAKHYAROVA Zulfiya
14	TUR	KEBIC Burcu
15	GER	HEMMER Nina
16	KOR	KIM Hyung-Joo
17	BUL	TRANDEVA Valya Tihomirova
18	VIE	NGUYEN Thi Lua
19	LAT	TJAPICO Karalina
20	MEX	MARTINEZ Wendy
21	RSA	MADI Mpho
21	HUN	KOROSI Kitti Angela
23	VEN	RIVAS Aguis

REPECHAGE

REPECHAGE FINALISTE 1

8	0/0 VIE	6	4/8 PRK	1	0/0 USA
6	5/8 PRK	1	0/0 USA		
6 SO Sim Hyang (PRK)					

Mdaille de Bronze

REPECHAGE FINALISTE 2

13	1/7 RUS	14	1/3 BLR	11	1/6 UKR
14	3/7 BLR	11	4/8 UKR	18	3/8 CAN
18 MACDONALD BONDY J. (CAN)					

Mdaille de Bronze

**Classement****Sitetalk Wrestling World Championships**

STYLE : FW 51 kg

**1 - Or / Gold**

SUN Yanan

2 - Argent / Silver

ERDENECHIMEG Sumiya

3 - Bronze

SO Sim HyangMACDONALD BONDY Jessica Anne Marie

<i>Classement</i>	<i>Nom - Name</i>	<i>Pays - Country</i>
1	SUN Yanan	CHN
2	ERDENECHIMEG Sumiya	MGL
3	SO Sim Hyang	PRK
3	MACDONALD BONDY J.	CAN
5	BLAHINYA Yuliya	UKR
5	ANTHONY V.	USA
7	KURACHKINA Iryna	BLR
8	SAMBOU Isabelle	SEN
9	MIYAHARA Yu	JPN
10	- Vinesh	IND
11	ZASINA R.	POL
12	KRASNOVA Ekatarina	RUS
13	YAKHYAROVA Zulfiya	KAZ
14	KEBIC Burcu	TUR
15	HEMMER Nina	GER
16	KIM Hyung-Joo	KOR
17	TRANDEVA V.	BUL
18	NGUYEN Thi Lua	VIE
19	TJAPICO Karalina	LAT
20	MARTINEZ Wendy	MEX
21	MADI Mpho	RSA
21	KOROSI Kitti Angela	HUN
23	RIVAS Aguis	VEN



Classement

Sitetalk Wrestling World Championships

STYLE : FW 55 kg



1 - Or / Gold

YOSHIDA Saori

2 - Argent / Silver

MATTSSON Sofia Magdalena

3 - Bronze



BARKA Emese

KOBLOVA Valeriia

<i>Classement</i>	<i>Nom - Name</i>	<i>Pays - Country</i>
1	YOSHIDA Saori	JPN
2	MATTSSON S.	SWE
3	BARKA Emese	HUN
3	KOBLOVA Valeriia	RUS
5	HRISTOVA M.	BUL
5	HUSYAK Iryna	UKR
7	MAROULIS H.	USA
8	SUNDEV Byambatseren	MGL
9	PREVOLARAKI Maria	GRE
10	AMRI Marwa	TUN
11	ISMAGULOVA Aizhan	KAZ
12	GÄ¼N Bediha	TUR
13	GALLAYS J.	CAN
14	PHAM Thi Hue	VIE
15	UM Jieun	KOR
16	ZHONG Xuechun	CHN
17	PAVAL Ana Maria	ROU
18	ESANU Mariana	MDA
18	KRAWCZYK Katarzyna	POL
20	MARTINAKOVA Lenka	CZE
21	HAN Kum Ok	PRK
22	POURI-LANE K.	NZL
23	BASSET Aurelie	FRA
24	VALENCIA Jane	MEX
24	- Pooja	IND
24	HANCHAR YANUSHKEVICH K.	BLR
24	HAUPTMANN Nicole	GER
28	SHAKIROVA Lilyia	UZB



Feuille de compétition / Competition Sheet

Sitetalk Wrestling World Championships



STYLE : FW 59 kg

QUALIFICATION			1/8 FINALE			1/4 FINALE			1/2 FINALE			FINALE																	
1		ZWIRYDOWSKA A. (POL)				1	1	POL	P1	P2	P3	2	0	MGL	P1	P2	P3	3	5	HUN	P1	P2	P3	3	4	HUN	P1	P2	P3
						2	2	MGL	P1	P2	P3																		
2		TUNGALAG Munkhtuya (MGL)				2	3	MGL	P1	P2	P3	3	4	HUN	P1	P2	P3	3	4	HUN	P1	P2	P3	3	4	HUN	P1	P2	P3
						3	4	HUN	P1	P2	P3	3	4	HUN	P1	P2	P3	3	4	HUN	P1	P2	P3	3	4	HUN	P1	P2	P3
3		SASTIN Marianna (HUN)				3	4	HUN	P1	P2	P3	3	4	HUN	P1	P2	P3	3	4	HUN	P1	P2	P3	3	4	HUN	P1	P2	P3
						4	0	TPE	P1	P2	P3	3	4	HUN	P1	P2	P3	3	4	HUN	P1	P2	P3	3	4	HUN	P1	P2	P3
4		HOU Min-wen (TPE)				4	0	TPE	P1	P2	P3	3	4	HUN	P1	P2	P3	3	4	HUN	P1	P2	P3	3	4	HUN	P1	P2	P3
						5	5	USA	P1	P2	P3	3	4	HUN	P1	P2	P3	3	4	HUN	P1	P2	P3	3	4	HUN	P1	P2	P3
5		RAGAN A. (USA)				5	5	USA	P1	P2	P3	3	4	HUN	P1	P2	P3	3	4	HUN	P1	P2	P3	3	4	HUN	P1	P2	P3
						6	0	RUS	P1	P2	P3	3	4	HUN	P1	P2	P3	3	4	HUN	P1	P2	P3	3	4	HUN	P1	P2	P3
6		LIPATOVA Svetlana (RUS)				6	0	RUS	P1	P2	P3	3	4	HUN	P1	P2	P3	3	4	HUN	P1	P2	P3	3	4	HUN	P1	P2	P3
						7	0	KAZ	P1	P2	P3	3	4	HUN	P1	P2	P3	3	4	HUN	P1	P2	P3	3	4	HUN	P1	P2	P3
7		KASSYMOVA Ayaulym (KAZ)				7	0	KAZ	P1	P2	P3	3	4	HUN	P1	P2	P3	3	4	HUN	P1	P2	P3	3	4	HUN	P1	P2	P3
						8	5	JPN	P1	P2	P3	3	4	HUN	P1	P2	P3	3	4	HUN	P1	P2	P3	3	4	HUN	P1	P2	P3
8	5	ITO Ayaka (JPN)	P1	P2	P3	8	5	JPN	P1	P2	P3	3	4	HUN	P1	P2	P3	3	4	HUN	P1	P2	P3	3	4	HUN	P1	P2	P3
	11		11	0	0	8	5	JPN	P1	P2	P3	3	4	HUN	P1	P2	P3	3	4	HUN	P1	P2	P3	3	4	HUN	P1	P2	P3
9	0	CANON CARVAJAL S. (COL)	P1	P2	P3	8	7	JPN	P1	P2	P3	3	4	HUN	P1	P2	P3	3	4	HUN	P1	P2	P3	3	4	HUN	P1	P2	P3
	3		3	0	0	8	7	JPN	P1	P2	P3	3	4	HUN	P1	P2	P3	3	4	HUN	P1	P2	P3	3	4	HUN	P1	P2	P3
10	0	MIKHALKOVA Nadzeya (BLR)	P1	P2	P3	8	7	JPN	P1	P2	P3	3	4	HUN	P1	P2	P3	3	4	HUN	P1	P2	P3	3	4	HUN	P1	P2	P3
	0		0	0	0	8	7	JPN	P1	P2	P3	3	4	HUN	P1	P2	P3	3	4	HUN	P1	P2	P3	3	4	HUN	P1	P2	P3
11	4	SOUZA DA SILVA J. (BRA)	P1	P2	P3	11	3	BRA	P1	P2	P3	3	4	HUN	P1	P2	P3	3	4	HUN	P1	P2	P3	3	4	HUN	P1	P2	P3
	7		7	0	0	11	3	BRA	P1	P2	P3	3	4	HUN	P1	P2	P3	3	4	HUN	P1	P2	P3	3	4	HUN	P1	P2	P3
12	2	ESTORNELL ELIZASTIGUE Y. (CUB)	P1	P2	P3	11	4	BRA	P1	P2	P3	3	4	HUN	P1	P2	P3	3	4	HUN	P1	P2	P3	3	4	HUN	P1	P2	P3
	3		3	0	0	11	4	BRA	P1	P2	P3	3	4	HUN	P1	P2	P3	3	4	HUN	P1	P2	P3	3	4	HUN	P1	P2	P3
13	1	PAIC G. (ROU)	P1	P2	P3	12	1	CUB	P1	P2	P3	3	4	HUN	P1	P2	P3	3	4	HUN	P1	P2	P3	3	4	HUN	P1	P2	P3
	2		2	0	0	12	1	CUB	P1	P2	P3	3	4	HUN	P1	P2	P3	3	4	HUN	P1	P2	P3	3	4	HUN	P1	P2	P3
14	0	- Geeta (IND)	P1	P2	P3	12	2	CUB	P1	P2	P3	3	4	HUN	P1	P2	P3	3	4	HUN	P1	P2	P3	3	4	HUN	P1	P2	P3
	3		3	0	0	12	2	CUB	P1	P2	P3	3	4	HUN	P1	P2	P3	3	4	HUN	P1	P2	P3	3	4	HUN	P1	P2	P3
15	5	RATKEVICH Yuliya (AZE)	P1	P2	P3	15	5	AZE	P1	P2	P3	3	4	HUN	P1	P2	P3	3	4	HUN	P1	P2	P3	3	4	HUN	P1	P2	P3
	4		4	0	0	15	5	AZE	P1	P2	P3	3	4	HUN	P1	P2	P3	3	4	HUN	P1	P2	P3	3	4	HUN	P1	P2	P3
16	5	PHAM Thi Loan (VIE)	P1	P2	P3	15	4	AZE	P1	P2	P3	3	4	HUN	P1	P2	P3	3	4	HUN	P1	P2	P3	3	4	HUN	P1	P2	P3
	8		8	0	0	15	4	AZE	P1	P2	P3	3	4	HUN	P1	P2	P3	3	4	HUN	P1	P2	P3	3	4	HUN	P1	P2	P3
17	0	RIEGLER Martina (AUT)	P1	P2	P3	16	0	VIE	P1	P2	P3	3	4	HUN	P1	P2	P3	3	4	HUN	P1	P2	P3	3	4	HUN	P1	P2	P3
	2		2	0	0	16	0	VIE	P1	P2	P3	3	4	HUN	P1	P2	P3	3	4	HUN	P1	P2	P3	3	4	HUN	P1	P2	P3
18	5	YUSEIN T. (BUL)	P1	P2	P3	18	5	BUL	P1	P2	P3	3	4	HUN	P1	P2	P3	3	4	HUN	P1	P2	P3	3	4	HUN	P1	P2	P3
	5		5	0	0	18	5	BUL	P1	P2	P3	3	4	HUN	P1	P2	P3	3	4	HUN	P1	P2	P3	3	4	HUN	P1	P2	P3
19	0	LAVRECHUK Tetyana (UKR)	P1	P2	P3	18	3	BUL	P1	P2	P3	3	4	HUN	P1	P2	P3	3	4	HUN	P1	P2	P3	3	4	HUN	P1	P2	P3
	0		0	0	0	18	3	BUL	P1	P2	P3	3	4	HUN	P1	P2	P3	3	4	HUN	P1	P2	P3	3	4	HUN	P1	P2	P3
20	0	YANG Chen (CHN)	P1	P2	P3	18	4	BUL	P1	P2	P3	3	4	HUN	P1	P2	P3	3	4	HUN	P1	P2	P3	3	4	HUN	P1	P2	P3
	4		4	0	0	18	4	BUL	P1	P2	P3	3	4	HUN	P1	P2	P3	3	4	HUN	P1	P2	P3	3	4	HUN	P1	P2	P3
21	5	STONE Braxton Rei (CAN)	P1	P2	P3	21	0	CAN	P1	P2	P3	3	4	HUN	P1	P2	P3	3	4	HUN	P1	P2	P3	3	4	HUN	P1	P2	P3
	2		2	0	0	21	0	CAN	P1	P2	P3	3	4	HUN	P1	P2	P3	3	4	HUN	P1	P2	P3	3	4	HUN	P1	P2	P3
22	1	HENRIQUEZ HERNANDEZ M. (VEN)	P1	P2	P3	23	4	KGZ	P1	P2	P3	3	4	HUN	P1	P2	P3	3	4	HUN	P1	P2	P3	3	4	HUN	P1	P2	P3
	1		1	0	0	23	4	KGZ	P1	P2	P3	3	4	HUN	P1	P2	P3	3	4	HUN	P1	P2	P3	3	4	HUN	P1	P2	P3
23	4	TYNYBEKOVA Aisuluu (KGZ)	P1	P2	P3	23	12	KGZ	P1	P2	P3	3	4	HUN	P1	P2	P3	3	4	HUN	P1	P2	P3	3	4	HUN	P1	P2	P3
	8		8	0	0	23	12	KGZ	P1	P2	P3	3	4	HUN	P1	P2	P3	3	4	HUN	P1	P2	P3	3	4	HUN	P1	P2	P3
24	5	SANCHEZ RAMIS K. (ESP)	P1	P2	P3	23	1	KGZ	P1	P2	P3	3	4	HUN	P1	P2	P3	3	4	HUN	P1	P2	P3	3	4	HUN	P1	P2	P3
	5		5	0	0	23	1	KGZ	P1	P2	P3	3	4	HUN	P1	P2	P3	3	4	HUN	P1	P2	P3	3	4	HUN	P1	P2	P3
25	0	RIABI Hela (TUN)	P1	P2	P3	24	1	ESP	P1	P2	P3	3	4	HUN	P1	P2	P3	3	4	HUN	P1	P2	P3	3	4	HUN	P1	P2	P3
	0		0	0	0	24	1	ESP	P1	P2	P3	3	4	HUN	P1	P2	P3	3	4	HUN	P1	P2	P3	3	4	HUN	P1	P2	P3

3 SASTIN Marianna (HUN)

Classement

Cl	Pays	Nom
1	HUN	SASTIN Marianna
2	BUL	YUSEIN Taybe Mustafa
3	MGL	TUNGALAG Munkhtuya
3	AZE	RATKEVICH Yuliya
5	JPN	ITO Ayaka
5	UKR	LAVRECHUK Tetyana
7	KGZ	TYNYBEKOVA Aisuluu
8	BRA	SOUZA DA SILVA Joice
9	USA	RAGAN Allison Mackenzie
10	ESP	SANCHEZ RAMIS Karima
11	VIE	PHAM Thi Loan
12	CAN	STONE Braxton Rei
13	CUB	ESTORNELL ELIZASTIGUE Yaquelin
14	ROU	PAIC Georgiana Narcisa
15	POL	ZWIRYDOWSKA Anna Teresa
16	TPE	HOU Min-wen
17	VEN	HENRIQUEZ HERNANDEZ Mirna Caro
18	CHN	YANG Chen
19	IND	- Geeta
20	COL	CANON CARVAJAL Sayury Yormary
21	AUT	RIEGLER Martina
22	TUN	RIABI Hela
23	KAZ	KASSYMOVA Ayaulym
23	BLR	MIKHALKOVA Nadzeya
25	RUS	LIPATOVA Svetlana

REPECHAGE

REPECHAGE FINALISTE 1

4	1	TPE	P1	P2	P3	2	5	MGL	P1	P2	P3
	2		2	0	0		7		7	0	0
2	4	MGL	P1	P2	P3	8	0	JPN	P1	P2	P3
	10		10	0	0		2		2	0	0

2 TUNGALAG Munkhtuya (MGL)

Mdaille de Bronze

REPECHAGE FINALISTE 2

19	5	UKR	P1	P2	P3	19	5	UKR	P1	P2	P3
	0		0	0	0		4		4	0	0
21	0	CAN	P1	P2	P3	19	1	UKR	P1	P2	P3
	0		0	0	0		4		4	0	0
						23	0	KGZ	P1	P2	P3
							0		0	0	0

15 RATKEVICH Yuliya (AZE)

Mdaille de Bronze

**Classement****Sitetalk Wrestling World Championships**

STYLE : FW 59 kg

**1 - Or / Gold**

SASTIN Marianna

2 - Argent / Silver

YUSEIN Taybe Mustafa

3 - Bronze

TUNGALAG Munkhtuya

RATKEVICH Yuliya

Classement	Nom - Name	Pays - Country
1	SASTIN Marianna	HUN
2	YUSEIN T.	BUL
3	TUNGALAG Munkhtuya	MGL
3	RATKEVICH Yuliya	AZE
5	ITO Ayaka	JPN
5	LAVRENCHUK Tetyana	UKR
7	TYNYBEKOVA Aisuluu	KGZ
8	SOUZA DA SILVA J.	BRA
9	RAGAN A.	USA
10	SANCHEZ RAMIS K.	ESP
11	PHAM Thi Loan	VIE
12	STONE Braxton Rei	CAN
13	ESTORNELL ELIZASTIGUE Y.	CUB
14	PAIC G.	ROU
15	ZWIRYDOWSKA A.	POL
16	HOU Min-wen	TPE
17	HENRIQUEZ HERNANDEZ M.	VEN
18	YANG Chen	CHN
19	- Geeta	IND
20	CANON CARVAJAL S.	COL
21	RIEGLER Martina	AUT
22	RIABI Hela	TUN
23	KASSYMOVA Ayaulym	KAZ
23	MIKHALKOVA Nadzeya	BLR
25	LIPATOVA Svetlana	RUS



Feuille de compétition / Competition Sheet

Sitewrestling World Championships



STYLE : FW 63 kg

QUALIFICATION			1/8 FINALE			1/4 FINALE			1/2 FINALE			FINALE		
1		JOHANSSON H. (SWE)				1	1	SWE	P1	P2	P3			
							1		1	0	0			
2		XILUOZHUOMA XI (CHN)				2	3	CHN	P1	P2	P3			
							4		4	0	0			
3		ICHO Kaori (JPN)				3	4	JPN	P1	P2	P3			
							8		8	0	0			
4		LARIONOVA Y. (KAZ)				4	0	KAZ	P1	P2	P3			
							0		0	0	0			
5	0	BOUCHARD J. (CAN)	P1	P2	P3	6	1	UKR	P1	P2	P3			
	0		0	0	0		2		2	0	0			
6	5	VASYLENKO Ganna (UKR)	P1	P2	P3	7	0	JAKHAR Geetika (IND)	P1	P2	P3			
	6		6	0	0		0		0	0	0			
7	0	JAKHAR Geetika (IND)	P1	P2	P3	8	3	BLR	P1	P2	P3			
	0		0	0	0		8		8	0	0			
8	5	MAMASHUK Maria (BLR)	P1	P2	P3	8	8	BLR	P1	P2	P3			
	5		5	0	0		8		8	0	0			
9	0	TOSUN Buse (TUR)	P1	P2	P3	10	5	COL	P1	P2	P3			
	0		0	0	0		12		12	0	0			
10	5	RENERIA CASTILLO J. (COL)	P1	P2	P3	10	8	COL	P1	P2	P3			
	8		8	0	0		10		10	5	6			
11	1	VIDIAUX LOPEZ K. (CUB)	P1	P2	P3	12	0	AZE	P1	P2	P3			
	3		3	0	0		4		4	0	0			
12	4	NETREBA I. (AZE)	P1	P2	P3	13	5	POL	P1	P2	P3			
	11		11	0	0		8		8	0	0			
13	4	MICHALIK M. (POL)	P1	P2	P3	13	1	POL	P1	P2	P3			
	8		8	0	0		2		2	0	0			
14	0	PAPAVASILEIOU A. (GRE)	P1	P2	P3	16	0	SEN	P1	P2	P3			
	0		0	0	0		0		0	0	0			
15	0	NGUYEN Thi (VIE)	P1	P2	P3	16	0	SEN	P1	P2	P3			
	0		0	0	0		0		0	0	0			
16	5	SAMBOU Anta (SEN)	P1	P2	P3	17	1	SANDOR Klaudia (HUN)	P1	P2	P3			
	7		7	0	0		2		2	0	0			
17	1	SANDOR Klaudia (HUN)	P1	P2	P3	18	4	OLIVEIRA Lais (BRA)	P1	P2	P3			
	2		2	0	0		6		6	0	0			
18	4	OLIVEIRA Lais (BRA)	P1	P2	P3	19	4	BRATCHIKOVA A. (RUS)	P1	P2	P3			
	6		6	0	0		8		8	0	0			
19	4	BRATCHIKOVA A. (RUS)	P1	P2	P3	19	3	RUS	P1	P2	P3			
	8		8	0	0		5		5	0	0			
20	0	BOBEVA V. (BUL)	P1	P2	P3	20	0	BOBEVA V. (BUL)	P1	P2	P3			
	0		0	0	0		0		0	0	0			
21	3	GARCIA GARRIDO I. (ESP)	P1	P2	P3	21	0	ESP	P1	P2	P3			
	6		6	0	0		2		2	0	0			
22	1	RAFFLER Laura (AUT)	P1	P2	P3	23	0	ITA	P1	P2	P3			
	2		2	0	0		0		0	0	0			
23	4	DIANA Maria (ITA)	P1	P2	P3	23	5	ITA	P1	P2	P3			
	7		7	0	0		3		3	0	0			
24	0	GERINGER Zumicke (RSA)	P1	P2	P3	25	4	PIROZHKOVA Elena (USA)	P1	P2	P3			
	0		0	0	0		9		9	0	0			
25	4	PIROZHKOVA Elena (USA)	P1	P2	P3	25	0	USA	P1	P2	P3			
	9		9	0	0		3		3	0	0			
26	1	FARG Hayat (EGY)	P1	P2	P3	27	0	GRIMAN HERRERA N. (VEN)	P1	P2	P3			
	2		2	0	0		0		0	0	0			
27	0	GRIMAN HERRERA N. (VEN)	P1	P2	P3	28	5	MGL	P1	P2	P3			
	0		0	0	0		9		9	0	0			
28	5	SORONZONBOLD B. (MGL)	P1	P2	P3	28	5	MGL	P1	P2	P3			
	3		3	0	0		7		7	0	0			

3 ICHO Kaori (JPN)

Classement

Cl	Pays	Nom
1	JPN	ICHO Kaori
2	MGL	SORONZONBOLD Battsetseg
3	KAZ	LARIONOVA Yekaterina
3	USA	PIROZHKOVA Elena
5	COL	RENERIA CASTILLO Jackeline
5	RUS	BRATCHIKOVA Anastasia
7	POL	MICHALIK Monika Ewa
8	ITA	DIANA Maria
9	BLR	MAMASHUK Maria
10	UKR	VASYLENKO Ganna
11	SEN	SAMBOU Anta
12	AZE	NETREBA Irina Petrovna
13	BRA	OLIVEIRA Lais
14	ESP	GARCIA GARRIDO Irene
15	CHN	XILUOZHUOMA XI
16	CUB	VIDIAUX LOPEZ Katerina
17	AUT	RAFFLER Laura
17	HUN	SANDOR Klaudia
19	EGY	FARG Hayat
20	SWE	JOHANSSON Henna Katarina
21	IND	JAKHAR Geetika
22	CAN	BOUCHARD Justine Angelle
23	RSA	GERINGER Zumicke
23	VIE	NGUYEN Thi
25	TUR	TOSUN Buse
25	GRE	PAPAVASILEIOU Agoro
25	BUL	BOBEVA Viktoria Ivanova
28	VEN	GRIMAN HERRERA Nathaly Josefina

REPECHAGE

REPECHAGE FINALISTE 1

4	4	KAZ	P1	P2	P3	4	5	KAZ	P1	P2	P3
	7		7	0	0		5		5	0	0
2	0	CHN	P1	P2	P3	10	0	COL	P1	P2	P3
	0		0	0	0		0		0	0	0

4 LARIONOVA Y. (KAZ)

Mdaille de Bronze

REPECHAGE FINALISTE 2

27	0	VEN	P1	P2	P3	25	4	USA	P1	P2	P3
	0		0	0	0		8		8	0	0
25	5	USA	P1	P2	P3	25	3	USA	P1	P2	P3
	7		7	0	0		2		2	0	0
						23	0	ITA	P1	P2	P3
							0		0	0	0

25 PIROZHKOVA Elena (USA)

Mdaille de Bronze

**Classement****Sitetalk Wrestling World Championships**

STYLE : FW 63 kg

**1 - Or / Gold**

ICHO Kaori

2 - Argent / Silver

SORONZONBOLD Battsetseg

3 - Bronze

LARIONOVA Yekaterina

PIROZHKOVA Elena

Classement	Nom - Name	Pays - Country
1	ICHO Kaori	JPN
2	SORONZONBOLD B.	MGL
3	LARIONOVA Y.	KAZ
3	PIROZHKOVA Elena	USA
5	RENERIA CASTILLO J.	COL
5	BRATCHIKOVA A.	RUS
7	MICHALIK Monika Ewa	POL
8	DIANA Maria	ITA
9	MAMASHUK Maria	BLR
10	VASYLENKO Ganna	UKR
11	SAMBOU Anta	SEN
12	NETREBA I.	AZE
13	OLIVEIRA Lais	BRA
14	GARCIA GARRIDO I.	ESP
15	XILUOZHUOMA XI	CHN
16	VIDIAUX LOPEZ K.	CUB
17	RAFFLER Laura	AUT
17	SANDOR Klaudia	HUN
19	FARG Hayat	EGY
20	JOHANSSON H.	SWE
21	JAKHAR Geetika	IND
22	BOUCHARD J.	CAN
23	GERINGER Zumicke	RSA
23	NGUYEN Thi	VIE
25	TOSUN Buse	TUR
25	PAPAVASILEIOU Agoro	GRE
25	BOBEVA V.	BUL
28	GRIMAN HERRERA N.	VEN



Feuille de compétition / Competition Sheet

Sitetalk Wrestling World Championships



STYLE : FW 67 kg

QUALIFICATION		1/8 FINALE		1/4 FINALE		1/2 FINALE		FINALE	
1	ZUTOVA Gozal (AZE)	1	4/6 AZE	1	1/1 AZE	4	3/8 CAN	4	0/2 CAN
2	SYZDYKOVA Elmira (KAZ)	2	0/0 KAZ	4	4/9 CAN	5	0/0 USA	7	1/6 CHN
3	OCHIRBAT N. (MGL)	3	1/2 MGL	7	4/7 CHN	7	0/0 USA	7	4/9 CHN
4	ANAKA Stacie (CAN)	4	3/3 CAN	8	0/0 ROU	9	5/4 UKR	9	5/3 UKR
5	CARLSON Veronica B (USA)	5	5/2 USA	9	3/5 UKR	9	0/0 GER	9	5/5 UKR
6	ANTER Nadia (EGY)	6	0/3 EGY	11	1/4 LAT	13	0/0 GER	19	0/4 JPN
7	ZHOU Zhangting (CHN)	7	4/7 CHN	13	3/5 GER	16	1/4 RUS	19	5/6 JPN
8	POPESCU A. (ROU)	8	0/0 ROU	16	1/4 RUS	18	0/0 POL	23	0/2 COL
9	STADNIK-MAKHYNIA A. (UKR)	9	4/7 UKR	19	5/4 UKR	19	5/3 UKR	23	4/9 COL
10	LEUCHANKA Halina (BLR)	10	0/0 BLR	19	5/4 UKR	19	5/3 UKR	23	0/2 COL
11	SKUJINA Laura (LAT)	11	5/5 LAT	19	5/4 UKR	19	5/3 UKR	23	0/2 COL
12	CANEVA Dalma (ITA)	12	0/0 ITA	19	5/4 UKR	19	5/3 UKR	23	0/2 COL
13	FOCKEN Aline (GER)	13	3/8 GER	19	5/4 UKR	19	5/3 UKR	23	0/2 COL
14	GODO Kitti (HUN)	14	1/2 HUN	19	5/4 UKR	19	5/3 UKR	23	0/2 COL
15	VASEVA E. (BUL)	15	1/3 BUL	19	5/4 UKR	19	5/3 UKR	23	0/2 COL
16	KUKSINA Natalia (RUS)	16	3/5 RUS	19	5/4 UKR	19	5/3 UKR	23	0/2 COL
17	DURUKAN Gamze (TUR)	17	0/0 TUR	19	5/4 UKR	19	5/3 UKR	23	0/2 COL
18	OSOCKA D. (POL)	18	4/7 POL	19	5/4 UKR	19	5/3 UKR	23	0/2 COL
19	DOSHO Sara (JPN)	19	5/7 JPN	19	5/4 UKR	19	5/3 UKR	23	0/2 COL
20	VAZQUEZ Luz Clara (ARG)	20	0/4 ARG	19	5/4 UKR	19	5/3 UKR	23	0/2 COL
21	DE OLIVEIRA G. (BRA)	21	1/4 BRA	19	5/4 UKR	19	5/3 UKR	23	0/2 COL
22	KAUR Navjot (IND)	22	3/11 IND	19	5/4 UKR	19	5/3 UKR	23	0/2 COL
23	IZQUIERDO MENDEZ L. (COL)	23	4/9 COL	19	5/4 UKR	19	5/3 UKR	23	0/2 COL
24	CHEN Wen-Ling (TPE)	24	0/0 TPE	19	5/4 UKR	19	5/3 UKR	23	0/2 COL

9\$STADNIK-MAKHYNIA A. (UKR)

Classement

Cl	Pays	Nom
1	UKR	STADNIK-MAKHYNIA Alina
2	CAN	ANAKA Stacie
3	MGL	OCHIRBAT Nasanburmaa
3	JPN	DOSHO Sara
5	CHN	ZHOU Zhangting
5	GER	FOCKEN Aline
7	LAT	SKUJINA Laura
8	COL	IZQUIERDO MENDEZ Leidy Marcela
9	AZE	ZUTOVA Gozal
10	USA	CARLSON Veronica B
11	POL	OSOCKA Daria Urszula
12	RUS	KUKSINA Natalia
13	IND	KAUR Navjot
14	BRA	DE OLIVEIRA Gilda Maria
15	BUL	VASEVA Elina Lyubchova
16	HUN	GODO Kitti
17	BLR	LEUCHANKA Halina
18	ARG	VAZQUEZ Luz Clara
19	EGY	ANTER Nadia
20	ITA	CANEVA Dalma
21	KAZ	SYZDYKOVA Elmira
22	ROU	POPESCU Adina Elena
22	TUR	DURUKAN Gamze
24	TPE	CHEN Wen-Ling

REPECHAGE

REPECHAGE FINALISTE 1

3	5/7 MGL	3	3/2 MGL
1	0/0 AZE	7	1/1 CHN

3 OCHIRBAT N. (MGL)

Mdaille de Bronze

REPECHAGE FINALISTE 2

10	1/2 BLR	11	0/0 LAT
11	4/10 LAT	13	3/3 GER

19 DOSHO Sara (JPN)

Mdaille de Bronze

**Classement****Sitetalk Wrestling World Championships**

STYLE : FW 67 kg

**1 - Or / Gold**

STADNIK-MAKHYNIA Alina

2 - Argent / Silver

ANAKA Stacie

3 - Bronze

OCHIRBAT Nasanburmaa

DOSHO Sara

Classement	Nom - Name	Pays - Country
1	STADNIK-MAKHYNIA A.	UKR
2	ANAKA Stacie	CAN
3	OCHIRBAT N.	MGL
3	DOSHO Sara	JPN
5	ZHOU Zhangting	CHN
5	FOCKEN Aline	GER
7	SKUJINA Laura	LAT
8	IZQUIERDO MENDEZ L.	COL
9	ZUTOVA Gozal	AZE
10	CARLSON Veronica B	USA
11	OSOCKA D.	POL
12	KUKSINA Natalia	RUS
13	KAUR Navjot	IND
14	DE OLIVEIRA G.	BRA
15	VASEVA E.	BUL
16	GODO Kitti	HUN
17	LEUCHANKA Halina	BLR
18	VAZQUEZ Luz Clara	ARG
19	ANTER Nadia	EGY
20	CANEVA Dalma	ITA
21	SYZDYKOVA Elmira	KAZ
22	POPESCU Adina Elena	ROU
22	DURUKAN Gamze	TUR
24	CHEN Wen-Ling	TPE



Feuille de compétition / Competition Sheet

Sitewrestling World Championships



STYLE : FW 72 kg

QUALIFICATION				1/8 FINALE				1/4 FINALE				1/2 FINALE				FINALE											
1		MANYUROVA Guzel (KAZ)						1	0	4	KAZ	P1	P2	P3				2	4	9	CHN	P1	P2	P3			
2		ZHANG Fengliu (CHN)						2	5	4	CHN	P1	P2	P3				2	4	10	CHN	P1	P2	P3			
3		OLAYA GUTIERREZ A. (COL)						3	0	2	COL	P1	P2	P3				4	1	2	USA	P1	P2	P3			
4		GRAY Adeline Maria (USA)						4	5	4	USA	P1	P2	P3				2	5	3	CHN	P1	P2	P3			
5		HEO Namju (KOR)						5	5	0	KOR	P1	P2	P3				5	0	0	KOR	P1	P2	P3			
6		ALI Annabel Laure (CMR)						6	0	0	CMR	P1	P2	P3				8	1	3	TUR	P1	P2	P3			
7		DA SILVA FERREIRA A. (BRA)						7	0	0	BRA	P1	P2	P3				8	5	8	TUR	P1	P2	P3			
8	5	ADAR Yaemin (TUR)	P1	P2	P3			8	4	8	TUR	P1	P2	P3				11	1	1	FRA	P1	P2	P3			
9	0	- Jyoti (IND)	P1	P2	P3			8	8	8	TUR	P1	P2	P3				11	1	1	FRA	P1	P2	P3			
10	1	GASTL Marina (AUT)	P1	P2	P3			11	4	9	FRA	P1	P2	P3				12	4	9	EST	P1	P2	P3			
11	3	VESCAN C. (FRA)	P1	P2	P3			11	9	9	FRA	P1	P2	P3				12	1	1	EST	P1	P2	P3			
12	4	MAE Epp (EST)	P1	P2	P3			12	1	1	EST	P1	P2	P3				14	0	0	MDA	P1	P2	P3			
13	1	NEMETH Zsanett (HUN)	P1	P2	P3			12	1	1	EST	P1	P2	P3				14	3	2	MDA	P1	P2	P3			
14	4	SAENKO Svetlana (MDA)	P1	P2	P3			14	4	12	MDA	P1	P2	P3				16	1	3	GER	P1	P2	P3			
15	0	WEFFER GUANIPA J. (VEN)	P1	P2	P3			14	12	12	MDA	P1	P2	P3				16	3	3	GER	P1	P2	P3			
16	4	SELMAIER Maria (GER)	P1	P2	P3			16	1	3	GER	P1	P2	P3				19	5	8	CAN	P1	P2	P3			
17	0	MOSPAN Maryna (UKR)	P1	P2	P3			16	3	3	GER	P1	P2	P3				19	7	7	CAN	P1	P2	P3			
18	0	HECHAVARRIA MEDINA L. (CUB)	P1	P2	P3			19	5	8	CAN	P1	P2	P3				20	0	0	SWE	P1	P2	P3			
19	4	WIEBE E. (CAN)	P1	P2	P3			19	8	8	CAN	P1	P2	P3				20	4	4	SWE	P1	P2	P3			
20	4	FRANSSON A. (SWE)	P1	P2	P3			20	0	4	SWE	P1	P2	P3				22	5	8	JPN	P1	P2	P3			
21	0	MARZALIUK Vasilisa (BLR)	P1	P2	P3			22	0	0	JPN	P1	P2	P3				23	0	0	ISR	P1	P2	P3			
22	5	SUZUKI Hiroe (JPN)	P1	P2	P3			22	0	0	JPN	P1	P2	P3				24	0	0	MGL	P1	P2	P3			
23	0	KRATYSH Ilana (ISR)	P1	P2	P3			23	0	0	ISR	P1	P2	P3				24	1	1	JPN	P1	P2	P3			
24	0	OCHIRBAT Burmaa (MGL)	P1	P2	P3			24	0	0	MGL	P1	P2	P3				25	4	7	RUS	P1	P2	P3			
25	4	VOROBEOVA Natalia (RUS)	P1	P2	P3			25	5	3	RUS	P1	P2	P3				25	0	5	RUS	P1	P2	P3			

2 ZHANG Fengliu (CHN)

Classement

Cl	Pays	Nom
1	CHN	ZHANG Fengliu
2	RUS	VOROBEOVA Natalia
3	USA	GRAY Adeline Maria
3	MGL	OCHIRBAT Burmaa
5	TUR	ADAR Yaemin
5	MDA	SAENKO Svetlana
7	CAN	WIEBE Erica Elizabeth
8	FRA	VESCAN Cynthia Vanessa
9	JPN	SUZUKI Hiroe
10	EST	MAE Epp
11	GER	SELMAIER Maria
12	KOR	HEO Namju
13	SWE	FRANSSON Anna Jenny Eva Maria
14	KAZ	MANYUROVA Guzel
15	AUT	GASTL Marina
16	HUN	NEMETH Zsanett
17	IND	- Jyoti
18	COL	OLAYA GUTIERREZ Andrea Carolina
19	CMR	ALI Annabel Laure
20	BLR	MARZALIUK Vasilisa
21	VEN	WEFFER GUANIPA Jaramit Leonor
21	UKR	MOSPAN Maryna
21	CUB	HECHAVARRIA MEDINA Lisset
24	BRA	DA SILVA FERREIRA Aline
24	ISR	KRATYSH Ilana

REPECHAGE

REPECHAGE FINALISTE 1

1	1	KAZ	P1	P2	P3			4	3	8	USA	P1	P2	P3		
4	3	USA	P1	P2	P3			8	1	2	TUR	P1	P2	P3		

4 GRAY Adeline Maria (USA)

Mdaille de Bronze

REPECHAGE FINALISTE 2

24	3	MGL	P1	P2	P3			24	3	5	MGL	P1	P2	P3			24	3	3	MGL	P1	P2	P3		
22	1	JPN	P1	P2	P3			19	1	3	CAN	P1	P2	P3			14	0	0	MDA	P1	P2	P3		

24 OCHIRBAT Burmaa (MGL)

Mdaille de Bronze

**Classement****Sitetalk Wrestling World Championships**

STYLE : FW 72 kg

**1 - Or / Gold**

ZHANG Fengliu

2 - Argent / Silver

VOROBEOVA Natalia

3 - Bronze

GRAY Adeline Maria

OCHIRBAT Burmaa

Classement	Nom - Name	Pays - Country
1	ZHANG Fengliu	CHN
2	VOROBEOVA Natalia	RUS
3	GRAY Adeline Maria	USA
3	OCHIRBAT Burmaa	MGL
5	ADAR Yaemin	TUR
5	SAENKO Svetlana	MDA
7	WIEBE E.	CAN
8	VESCAN C.	FRA
9	SUZUKI Hiroe	JPN
10	MAE Epp	EST
11	SELMAIER Maria	GER
12	HEO Namju	KOR
13	FRANSSON A.	SWE
14	MANYUROVA Guzel	KAZ
15	GASTL Marina	AUT
16	NEMETH Zsanett	HUN
17	- Jyoti	IND
18	OLAYA GUTIERREZ A.	COL
19	ALI Annabel Laure	CMR
20	MARZALIUK Vasilisa	BLR
21	WEFFER GUANIPA J.	VEN
21	MOSPAN Maryna	UKR
21	HECHAVARRIA MEDINA L.	CUB
24	DA SILVA FERREIRA A.	BRA
24	KRATYSH Ilana	ISR

SITETALK WRESTLING WORLD CHAMPIONSHIPS



BUDAPEST (HUN)

2013-09-16 - 2013-09-22 2013

Résultats - Results

Lutte Greco-Romaine - Greco-Roman



**Liste des arbitres / Referee list****Sitetalk Wrestling World Championships**

N°	Licence	Pays Country	Nom - Last Name	Prénom - First Name
	4675	AZE	JAFAROV	Azhdar
	4037	AZE	SHARIFOV	Hijran
	4696	BLR	BREL	Ihar
		BRA	CONCALVES	Eduardo
	2214	BUL	ALEXANDROV	Levon
		BUL	GOCHEV	Miroslav
	4633	BUL	GUETZOV	Valentin Dotchev
	3106	BUL	KOSTADINOV	Iantcho
		CAN	MACKAY	Lee
	4308	CHN	SUN	Jian
	3291	CHN	ZHANG	Xia
	2829	CRO	OCIC	Zvonko
	3364	CRO	PETANJEK	Davor
		CUB	MOLINA	Orestes
		CUB	RODRIGUEZ	Manuel
	4828	CZE	SCHEINER	Vaclav
		DEN	ATAY ZEYNEL	Lutfu
	4097	EGY	MOUSTAFA	Ibrahim Adel
	4177	ESP	GARCIA	Carlos
	2082	FIN	VEHVILÄ„INEN	Pertti
	2546	FRA	LEGLEUT	RÃ©gine
		FRA	MENU HRISTOV	Celine
	2513	GEO	MACHAIDZE	Edisher
		GER	MANZ	Uwe
		GRE	MIGIPI	Anastasia
	4357	HUN	BACSA	PÃ©ter
	3456	HUN	PÃ©TERI	LÃ©szlÃ© ³
	3051	IRI	RAMEZAN NEJAD	Ramezan Ali
		IRI	TALEBI	Bahman
	4112	IRQ	QASSIM	Ali
	4670	ISR	SHMUELY	Aviram
	4356	ITA	DÃ©ZSA	Edit
		ITA	MASI	Marco
	3218	JPN	ASHIDA	Takaharu
	4702	JPN	OKIYAMA	Isao
		JPN	SAITO	Osamu
	4697	KAZ	JAXYKULOV	Bakhytzhan
	3348	KGZ	AHMETOV	Meyrambek
	3349	KGZ	KULMATOV	Kochkor

**Liste des arbitres / Referee list****Sitetalk Wrestling World Championships**

N°	Licence	Pays Country	Nom - Last Name	Prénom - First Name
		KOR	CHUNG	Tong Kun
	2385	MAR	MOCHAFFAA	Noreddine
	4362	MGL	TUMURBAATAR	Baatar
	5034	NED	ABDOELAEV	Edmar
	3077	POL	BRUDZINSKI	Grzegorz
	3359	POL	LEBKOWSKI	Karol
	4150	ROU	GYARMATI	Ferenc
	2541	ROU	LAZAR	Ovidiu
	4729	RUS	ARUSTAMYAN	Noravard
	3749	RUS	KRIKOV	Andrey
	3267	RUS	NOVAKOVSKIY	Sergey
		SAM	VILLET	Charles
	3408	SLO	SERNEK	Stanislav
	4386	SVK	VOJKOVIC	Miroslav
		SWZ	PUTALLAZ	Alain
		TPE	JANG	Tsong Rong
	3520	TUR	CICIOGLU	Halil Ibrahim
	4433	TUR	SEN	Levent
	3623	TUR	YUCEL	Sadettin
	4192	USA	DAVIS	Stacey
	3924	USA	ERRETT	Zachary David
		USA	GOESSEL	Casey
		USA	JULIAN	Sam
	3284	UZB	GULAMOV	Tokhir
		UZB	KONSTANTIN	Mikhailov

Nombre d'arbitres - Number of Referee

64



















































Liste des nations / Countries List

Sitetalk Wrestling World Championships

STYLE GR



Pays - Country

	ALGERIE	ALG
	ALLEMAGNE	GER
	ARMENIE	ARM
	AUTRICHE	AUT
	AZERBAIDJAN	AZE
	BELARUS	BLR
	BRESIL	BRA
	BULGARIE	BUL
	CHINE	CHN
	COLOMBIA	COL
	COREE	KOR
	COREE RDP	PRK
	CROATIE	CRO
	CUBA	CUB
	DANEMARK	DEN
	DOMINICA	DOM
	EGYPTE	EGY
	ESPAGNE	ESP
	ESTONIE	EST
	FINLANDE	FIN
	FRANCE	FRA
	GEORGIE	GEO
	GREECE	GRE
	GUAM	GUM
	HOLLANDE	NED
	HONDURAS	HON
	HONGRIE	HUN
	INDIA	IND
	IRAK	IRQ
	IRAN R.I.	IRI
	ISRAEL	ISR
	ITALIE	ITA
	JAPON	JPN
	JORDANIE	JOR
	KAZAKHSTAN	KAZ
	KIRGIZSTAN	KGZ
	LETTONIE	LAT
	LITHUANIA	LTU
	MAROC	MAR
	MEXICO	MEX
	MOLDAVIE	MDA
	MONTÃ%NÃ%GRO	MNE
	NICARAGUA	NCA
	NORVEGE	NOR
	NOUVELLE-ZELANDE	NZL
	OUZBEKISTAN	UZB
	PANAMA	PAN
	POLOGNE	POL



Liste des nations / Countries List

Sitetalk Wrestling World Championships

STYLE GR



	PORTUGAL	POR
	ROUMANIE	ROU
	RUSSIE	RUS
	SERBIA	SRB
	SLOVAQUIE	SVK
	SLOVENIE	SLO
	SUEDE	SWE
	SUISSE	SUI
	TADJIKISTAN	TJK
	TAIPEI CHINESE	TPE
	TCHEQUE REP.	CZE
	TUNISIE	TUN
	TURQUIE	TUR
	UKRAINE	UKR
	UNITED STATES	USA
	URUGUAY	URU
	VENEZUELA	VEN
	VIETNAM	VIE

Nombre de nations - Number of Countries 66



Nombre d'engagés par nation / Number of Entries By Country

Sitetalk Wrestling World Championships

STYLE GR



<i>Pays - Country</i>	<i>120 KG</i>	<i>55 KG</i>	<i>60 KG</i>	<i>66 KG</i>	<i>74 KG</i>	<i>84 KG</i>	<i>96 KG</i>	<i>TOTAL</i>
KGZ		1	1	1	1	1		5
KOR	1	1	1	1	1		1	6
LAT					1			1
LTU	1			1	1	1		4
MAR		1						1
MDA		1	1	1	1		1	5
MEX			1		1	1		3
MNE					1			1
NCA			1					1
NED							1	1
NOR		1	1	1			1	4
NZL					1			1
PAN			1		1			2
POL	1	1	1	1	1	1	1	7
POR			1					1
PRK		1						1
ROU			1	1	1	1	1	5
RUS	1	1	1	1	1	1	1	7
SLO						1		1
SRB			1	1	1		1	4
SUI					1			1
SVK			1	1	1		1	4
SWE	1	1	1	1	1	1	1	7
TJK	1						1	2
TPE				1				1
TUN	1							1
TUR	1	1	1	1	1	1	1	7
UKR	1	1	1	1	1	1	1	7
URU	1							1
USA	1	1	1	1	1	1	1	7
UZB			1	1	1	1	1	5
VEN	1	1	1		1	1	1	6
VIE		1						1



Nombre d'engagés par nation / Number of Entries By Country

Sitetalk Wrestling World Championships

STYLE GR



<i>Pays - Country</i>	<i>120 KG</i>	<i>55 KG</i>	<i>60 KG</i>	<i>66 KG</i>	<i>74 KG</i>	<i>84 KG</i>	<i>96 KG</i>	<i>TOTAL</i>
TOTAL	27	33	39	39	39	35	37	249

Nombre de nations - Number of Countries **66**



Liste des Engagés par pays / Entry-List By Country

Sitetalk Wrestling World Championships



STYLE GR

ALGERIA (ALG)

Chef de délégation / Team Leader : CHEBBAH, Rabah
Entraîneur / Coach : BENRRAHMOUN, Mohamed
ROBERT, Asryan

Lutteur(s) / Wrestler(s) :

60 kg DJEDAIET, Mouatez
66 kg BENAÏSSA, Tarek Aziz

ARMENIA (ARM)

Chef de délégation / Team Leader : BAGHDADYAN, Arayik
YENOKYAN, Hrant
Entraîneur / Coach : ALEKSANYAN, Gevorg
GEVORGYAN, Samvel
SAHAKYAN, Eduard
JULFALAKYAN, Levon
Médecin / Medical Staff : KARAPETYAN, Ara
HARUTYUNYAN, Zaven
Kiné / Medical Staff : SARGSYAN, Telman
PETROSYAN, Artur

Lutteur(s) / Wrestler(s) :

120 kg YEGHIAZARYAN, Vachik
55 kg AMOYAN, Roman
60 kg MIKAYELYAN, Aleksan
66 kg GHAMBARYAN, Sasun
74 kg JULFALAKYAN, Arsen
84 kg MANUKYAN, Maksim
96 kg ALEKSANYAN, Artur

AUSTRIA (AUT)

Chef de délégation / Team Leader : HELMDACH, Jörg
Entraîneur / Coach : BODI, Jenő
ZENTGRAF, Ralph
Kiné / Medical Staff : KLAUS, Erich

Lutteur(s) / Wrestler(s) :

66 kg PUFFER, Benedikt
74 kg MARCHL, Florian
84 kg WAGNER, Michael



Liste des Engagés par pays / Entry-List By Country

Sitetalk Wrestling World Championships



STYLE GR

AZERBAIJAN (AZE)

Chef de délégation / Team Leader :	EYVAZOV, Tofig RZAYEV, Yashar
Entraîneur / Coach :	RAHMANI, Foad ADNANI, Rafid ELYASI, Shahram KHEYRABADI, Jamshid
Médecin / Medical Staff :	ALIYEV, Rauf
Kiné / Medical Staff :	ISMAYILOV, Seymur
Lutteur(s) / Wrestler(s) :	
120 kg	MEHRALIYEV, Zaur
55 kg	AHMADOV, Orkhan
60 kg	MAMMADOV, Kamran
66 kg	ALIYEV, Hasan
74 kg	HUSEYNOV, Rafig
84 kg	TAHMASEBI, Saman Ahman
96 kg	GADABADZE, Shalva

BELARUS (BLR)

Chef de délégation / Team Leader :	KAZAUSKI, Aliaksandr MEDVED, Aleksandr
Entraîneur / Coach :	CHANKO, Ivan MAJYDAU, Kamandar BAHDANIONAK, Mikalai MAKARANKA, Viachaslau SHUBAYEU, Zhumatai PANSTWA, Schengen SCHENGENER, Staaten SENGENO, VALSTYBES YERMAK, Anatoli MURZINKOU, Valiantsin
Médecin / Medical Staff :	YAKAULEU, Aliaksandr ZHUKOUSKI, Aliaksandr
Kiné / Medical Staff :	MIKHAILOUSKI, Aliaksandr HASPADARYK, Aliaksei
Lutteur(s) / Wrestler(s) :	
120 kg	CHUGOSHVILI, Ioseb
55 kg	TAZHYIEU, Elbek
60 kg	KALABAEYU, Erbol
66 kg	SIAMIONAU, Mikhail



Liste des Engagés par pays / Entry-List By Country

Sitetalk Wrestling World Championships



STYLE GR

74 kg	DTEMYANOVICH, Aliaksandr
84 kg	HAMZATAU, Javid
96 kg	HRABOVIK, Aliaksandr

BRAZIL (BRA)

Chef de délégation / Team Leader :	LEITAO, Roberto
Entraîneur / Coach :	ALDAMA, Angel
Lutteur(s) / Wrestler(s) :	
60 kg	RIBEIRO ROMANELLI, Diego
66 kg	DA SILVA FEITOSA, Andre Felipe

BULGARIA (BUL)

Entraîneur / Coach :	NAZARIAN, Armen RADULOVSKI, Milcho SHOPOV, Yanko MIN CHEV, Nikolaz Georgiev MIN CHEV, Nikolay Georgiev KARADUSHEV, Georgi SOFIADI, Rahmat
Médecin / Medical Staff :	BORISOV, Boris STRUGAROV, Stefan
Kiné / Medical Staff :	TONCHEV, Marin BORISOV, Emil
Lutteur(s) / Wrestler(s) :	
120 kg	METHODIEV, Miloslav Yuriev
55 kg	KOSTADINOV, Aleksandar Stoyanov
60 kg	ANGELOV, Ivo Serafimov
66 kg	PETROV, Plamen Todorov
74 kg	YANAKIEV, Yavor Dimitrov
84 kg	MARINOV, Hristo Diyanov
96 kg	METHODIEV, Vladislav Emilov

CHINA (CHN)

Chef de délégation / Team Leader :	XUE, Lian PENG, Zhao
Entraîneur / Coach :	WANG, Xiaoqi SHENG, Zetian LI, Guo



Liste des Engagés par pays / Entry-List By Country

Sitetalk Wrestling World Championships



STYLE GR

Lutteur(s) / Wrestler(s) :

120 kg	NIE, Xiaoming
55 kg	BAO, Liri
60 kg	ZHOU, Jingjie
66 kg	YAN, Pengfei
74 kg	YANG, Bin
84 kg	PENG, Fei
96 kg	XIAO, Di

COLOMBIA (COL)

Entraîneur / Coach : GUTIERREZ, David

Médecin / Medical Staff : CHICA, Catalina
RIOS, Fernando

Lutteur(s) / Wrestler(s) :

60 kg	LOPEZ, Juan Carlos
66 kg	CUERO, Alexis

CROATIA (CRO)

Entraîneur / Coach : JAKUBEK, Davor

Kiné / Medical Staff : SPASIC, Dean

Lutteur(s) / Wrestler(s) :

55 kg	LIZATOVIC, Ivan
60 kg	SOKOL, Tonimir
66 kg	ETLINGER, Dominik
74 kg	ZUGAJ, Neven
84 kg	ZUGAJ, Nenad

CUBA (CUB)

Chef de délégation / Team Leader : TELLEZ, Eduardo Perez

Entraîneur / Coach : GONZALEZ, Carlos Ulacia

Médecin / Medical Staff : CHACON, Siggilfredo Acosta

Lutteur(s) / Wrestler(s) :

60 kg	BORRERO MOLINA, Ismael
66 kg	MULENS HERRERA, Pedro Isaac
84 kg	PIQUET HERRERA, Gilberto
96 kg	LUGO CABRERA, Yasmany Daniel



Liste des Engagés par pays / Entry-List By Country

Sitetalk Wrestling World Championships

STYLE GR



CZECH REPUBLIC (CZE)

Chef de délégation / Team Leader : VARGA, Ervin
Entraîneur / Coach : SVEC, Marek
ZEMAN, Jaroslav

Lutteur(s) / Wrestler(s) :

55 kg	NOVAK, Michal
66 kg	MORBITCZER, Matous
74 kg	SOBECKY, Tomas
84 kg	OMAROV, Artur
96 kg	VALA, David

DENMARK (DEN)

Chef de délégation / Team Leader : LAVASANI, Amir
Entraîneur / Coach : KOGUT, Szymon
Médecin / Medical Staff : NYBLOM, Hakan
Kiné / Medical Staff : LARSEN, Kim

Lutteur(s) / Wrestler(s) :

60 kg	SKALS, Tobias Fonnesbek
74 kg	MADSEN, Mark Overgaard

DOMINICA (DOM)

Chef de délégation / Team Leader : SABUA, Olgui
Entraîneur / Coach : MARTINEZ, Ramades

Lutteur(s) / Wrestler(s) :

120 kg	GARCIA GARCIA, Ramon Antonio
55 kg	NOVAS FELIZ, Cristian Michael
60 kg	ENCARNACION, Francisco Antonio

EGYPT (EGY)

Chef de délégation / Team Leader : EL-HADAD, Hassan
Entraîneur / Coach : FATHALLA, Mahmoud

Lutteur(s) / Wrestler(s) :

55 kg	FAHMY MAHMOUD, Haithem Ahmed
84 kg	ABD ELSALAM SHIBL, Tarek Mohamed

ESTONIA (EST)



Liste des Engagés par pays / Entry-List By Country

Sitetalk Wrestling World Championships



STYLE GR

Chef de délégation / Team Leader : PÄ-LLUSTE, Henn
Entraîneur / Coach : PÄ-LLUSTE, Henn
Médecin / Medical Staff : JAIRUS, Aleksander

Lutteur(s) / Wrestler(s) :

120 kg	NABI, Heiki
55 kg	ZEINALOV, Anar
84 kg	APS, Eerik

FINLAND (FIN)

Chef de délégation / Team Leader : RAUHALA, Jukka
Entraîneur / Coach : LAPPALAINEN, Juha
YLI-HANNUKSELA, Marko
Médecin / Medical Staff : LEHTO, Mika
Kiné / Medical Staff : KURONEN, Hannu

Lutteur(s) / Wrestler(s) :

55 kg	HAAPAMÄKI, Jani Jukka
74 kg	SUOMINEN, Veli-Karri Osvald
84 kg	HIETANIEMI, Rami Antero
96 kg	KALLIO, Timo Antero

FRANCE (FRA)

Entraîneur / Coach : GONZALES AGUILERA, Daniel
MOURIER, Patrice
Médecin / Medical Staff : AISENBERG, Charles

Lutteur(s) / Wrestler(s) :

60 kg	BELMADANI, Tarik
96 kg	NOUMONVI, MÃlonin

GEORGIA (GEO)

Chef de délégation / Team Leader : KURTANIDZE, Luka-Eldar
Entraîneur / Coach : MINDORASHVILI, Revaz
KHASAIA, Badri
DARCHIA, Begi
TATISHVILI, Otar
SKHIRELI, Nuozar
MINDORASHVILI, Revaz
Médecin / Medical Staff : KAKHABRISHVILI, Zurab
Kiné / Medical Staff : PURTSELADZE, Mikheil



Liste des Engagés par pays / Entry-List By Country

Sitetalk Wrestling World Championships



STYLE GR

KELIKHASHVILI, Jemal

Lutteur(s) / Wrestler(s) :

120 kg	ARABULI, Levan
55 kg	PUTKARADZE, Bachana
60 kg	LASHKHI, Revaz
66 kg	DAVITAIA, Sachino
74 kg	GULBATASHVILI, Ilia
84 kg	TSIREKIDZE, Giorgi
96 kg	IMERLISHVILI, Vasil

GERMANY (GER)

Chef de délégation / Team Leader : ZAMANDURIDIS, Jannis

Entraîneur / Coach : CARL, Michael
HARTMANN, Frank
STAEBLER, Andreas
SASAMOTO, Makoto
GALWAS, Waldemar
WALDERMAR, Galwas

Médecin / Medical Staff : TRAGESER, Steffen
GSTÄTTNER, Hans
KLOTZ, Christian

Kiné / Medical Staff : SCHRENKER, Klaus

Lutteur(s) / Wrestler(s) :

120 kg	POPP, Eduard
55 kg	HOEGLMEIER, Lukas Hilmar
66 kg	STAEBLER, Frank
74 kg	NEUMAIER, Florian
84 kg	PONOMARTSCHUK, Eugen
96 kg	HASSLER, Oliver Adrian

GREECE (GRE)

Entraîneur / Coach : XENIDIS, Christoforos

Lutteur(s) / Wrestler(s) :

55 kg	KARATHANASIS, Lazaros
60 kg	THEODORAKIS, Christos
66 kg	MATIAS, Vladimiro
74 kg	MANOUILIDIS, Petros
84 kg	BOUKIS, Ilias



Liste des Engagés par pays / Entry-List By Country

Sitetalk Wrestling World Championships



STYLE GR

96 kg

VOURDANOS, Konstantinos

GUAM (GUM)

Chef de délégation / Team Leader : TBA,

Entraîneur / Coach : TBA,

Lutteur(s) / Wrestler(s) :

66 kg

LOPEZ JR, Joseph Dominic

HONDURAS (HON)

Entraîneur / Coach : RODRIGUEZ, Osvel

Lutteur(s) / Wrestler(s) :

66 kg

MEJIA SAMBULA, Jefrin Benito

84 kg

MARTINEZ ALVAREZ, Oscar Naman

96 kg

MEJIA CASTILLO, Kevin

HUNGARY (HUN)

Chef de délégation / Team Leader : MAROTHY, Istvan

Entraîneur / Coach : STRUHACS, Gyorgy

Médecin / Medical Staff : BAKANEK, Gyorgy

DR. TEMESI, Laszlo

Kiné / Medical Staff : HADI, Gergely

Lutteur(s) / Wrestler(s) :

120 kg

DEAK-BARDOS, Mihaly

55 kg

MODOS, Peter

60 kg

KOZAK, Istvan

66 kg

LORINCZ, Tamas

74 kg

KORPASI, Balint

84 kg

LORINCZ, Viktor

96 kg

KISS, Balazs

INDIA (IND)

Entraîneur / Coach : VINOD, Kumar

KUMAR, Virender

MESTVIRISHVILI, Vladimer

Médecin / Medical Staff : VIJAY, Vijay

VIKAS, Vikas

Kiné / Medical Staff : SHARMA, Rahul



Liste des Engagés par pays / Entry-List By Country

Sitetalk Wrestling World Championships



STYLE GR

Lutteur(s) / Wrestler(s) :

120 kg	NAVEEN, -
55 kg	GAURAV, Sharma
60 kg	RAVINDER, Singh
66 kg	SANDEEP, Tulsi Yadan
74 kg	RAJBIR, Chhikara
84 kg	HARPREET, Singh
96 kg	HARDEEP, Singh

IRAN R.I. (IRI)

Chef de délégation / Team Leader :

BAYAT, Ali

Entraîneur / Coach :

CHAMANGOLI, Abdollah
HOSSEIN ZADEH, Hassan
GHODRATI, Kamran
KARIMI ZADEH, Babak
GHALAVAND, Hossein
GHESMATIAZARSHARBYANI, Mahdi
SAEDIFAR, Majid
KHADEM, RASOUL

Médecin / Medical Staff :

AMIRSASAN, Ramin
RASHIDLAMIR, Amir
AZADBAKHT, Davood

Kiné / Medical Staff :

KOVARI, Mohammad

Lutteur(s) / Wrestler(s) :

120 kg	ALIAKBARI, Amir Aziz
55 kg	FAGHIRI, Mohammad Eynollah
60 kg	NOURBAKHSI, Mohammad Naser
66 kg	BYABANGARD, Afshin Nemat
74 kg	ALIZADEHPOURNIA, Hadi Asadollah
84 kg	NEMATPOUR, Taleb Nariman
96 kg	ALIYARIFEIZABADI, Mahdi Abbas

IRAQ (IRQ)

Entraîneur / Coach :

HASSOON, Jamal Naser

Lutteur(s) / Wrestler(s) :

120 kg	ALGHADHRI, Ali Nadhim S
--------	-------------------------

ISRAEL (ISR)



Liste des Engagés par pays / Entry-List By Country

Sitetalk Wrestling World Championships



STYLE GR

Chef de délégation / Team Leader : SHULMAN, Leonid

Entraîneur / Coach : ZIMKIND, Ariel

Lutteur(s) / Wrestler(s) :

96 kg AVANESYAN, Robert

ITALY (ITA)

Chef de délégation / Team Leader : CAUDULLO, Antonino

Entraîneur / Coach : OLIVERA HERNANDEZ, JosÃ© Mario

Lutteur(s) / Wrestler(s) :

96 kg TIMONCINI, Daigoro

JAPAN (JPN)

Chef de délégation / Team Leader : MARUYAMA, Hideji

HASE, Hiroshi

TANIOKA, Kuniko

Entraîneur / Coach :

NISHIGUCHI, Shigeki

TOYOTA, Masatoshi

IMURO, Masaki

MABUCHI, Kenji

SAITO, Masashi

Médecin / Medical Staff :

NAGAO, Shigeno

MASUJIMA, Atsushi

NAKAJIMA, Kohei

Kiné / Medical Staff :

TAKAHASHI, Asuka

KAWASAKI, Atsushi

Lutteur(s) / Wrestler(s) :

120 kg MAEKAWA, Shori

55 kg TANOKURA, Shota

60 kg KURAMOTO, Kazuma

66 kg SHIMIZHU, Hiroyuki

74 kg KANAKUBO, Takehiro

84 kg OKA, Taichi

96 kg SAIKAWA, Norikatsu

JORDAN (JOR)

Lutteur(s) / Wrestler(s) :

96 kg ABUTABEEKH, Yahia Mohammad hussein



Liste des Engagés par pays / Entry-List By Country

Sitetalk Wrestling World Championships



STYLE GR

KAZAKHSTAN (KAZ)

Chef de délégation / Team Leader : UMRALIYEV, Ruslan

Entraîneur / Coach : ZHOLAMANOV, Kuandyk

AMANOV, Abutalip

ABDRASHEV, Askar

ONGGARBAIUY, Altay

UNDEMESEV, Ungarbay

Médecin / Medical Staff : KLIPAN, Andrey

Kiné / Medical Staff : KLIPAN, Sairan

Lutteur(s) / Wrestler(s) :

120 kg TINALIYEV, Nurmakhan

55 kg KALMURZAYEV, Nursultan

60 kg KEBISPAYEV, Almat

66 kg KONYRATOV, Yerbol

74 kg DILMUKHAMEDOV, Askhat

84 kg TURSUNOV, Nursultan

96 kg ISKAKOV, Yerulan

KYRGYZSTAN (KGZ)

Chef de délégation / Team Leader : USHAKOV, Vadim

Entraîneur / Coach : BAGALIEV, Kanatbek

ERKIMBAEV, Azat

MUSAEV, Magomed

IAKOVLEV, Budimir

SIVTCEV, Ivan

Médecin / Medical Staff : ALISHEVA, Baktygul

Lutteur(s) / Wrestler(s) :

55 kg ZHOLCHUBEKOV, Kanybek

60 kg ERALIEV, Arsen

66 kg TIUMENBAEV, Ruslan

74 kg KOZHOBEK UULU, Esengeldi

84 kg BEISHEBEKOV, Azat

LATVIA (LAT)

Chef de délégation / Team Leader : URBANCIKS, Dzintars

Entraîneur / Coach : CACS, Levnards

Lutteur(s) / Wrestler(s) :

74 kg VISNAKOV, Aleksandrs



Liste des Engagés par pays / Entry-List By Country

Sitetalk Wrestling World Championships

STYLE GR



LITHUANIA (LTU)

Entraîneur / Coach : KASIMOVAS, Segejus

Lutteur(s) / Wrestler(s) :

120 kg	MIZGAITIS, Mindaugas
66 kg	VENCKAITIS, Edgaras
74 kg	KAZAKEVIC, Aleksandr
84 kg	ADOMAITIS, Laimutis

MEXICO (MEX)

Lutteur(s) / Wrestler(s) :

60 kg	MENDEZ HIDALGO, Victor
74 kg	ESCOBAR, Huan Angel
84 kg	SALVADOR MEJIA, Hanssel Argel

MOLDOVA (MDA)

Chef de délégation / Team Leader : PEICOV, Victor

Entraîneur / Coach : CUCUL, Mihail

Lutteur(s) / Wrestler(s) :

55 kg	CIOBANU, Victor
60 kg	ISLAMOV, Donior
66 kg	COSNICEANU, Mihail
74 kg	BESLEAGA, Igor
96 kg	CAZAC, Marin

MONTENEGRO (MNE)

Lutteur(s) / Wrestler(s) :

74 kg	SAMURGASHEV, Rafael
-------	---------------------

MOROCCO (MAR)

Lutteur(s) / Wrestler(s) :

55 kg	FAJARI, Fouad
-------	---------------

NETHERLANDS (NED)

Lutteur(s) / Wrestler(s) :

96 kg	ABBASI DAZMIRI, Mehdi
-------	-----------------------



Liste des Engagés par pays / Entry-List By Country

Sitetalk Wrestling World Championships



STYLE GR

NEW ZEALAND (NZL)

Chef de délégation / Team Leader : GRAYLING, Mark
Kiné / Medical Staff : DAVIES, Andrea
Lutteur(s) / Wrestler(s) :
74 kg DAVIES, Clinton Richard Peter

NICARAGUA (NCA)

Lutteur(s) / Wrestler(s) :
60 kg MENDIETA FUENTES, Alberto Ramon

NORTH KOREA (PRK)

Chef de délégation / Team Leader : KIM, Il
Entraîneur / Coach : PAK , Pom Su
Lutteur(s) / Wrestler(s) :
55 kg YUN, Won Chol

NORWAY (NOR)

Entraîneur / Coach : LIDBERG, Jimmy
AANES, Fritz
Médecin / Medical Staff : GARTHE, Ina
Kiné / Medical Staff : OLOFSSON, Mats
Lutteur(s) / Wrestler(s) :
55 kg RONNINGEN, Thomas Andresen
60 kg BERGE, Stig-Andre
66 kg THOMMESEN, Marius Blomstadli
96 kg HAMLET NIELSEN, Marius

PANAMA (PAN)

Lutteur(s) / Wrestler(s) :
60 kg SOTO, Muise
74 kg ALMENDRA, Alvin

POLAND (POL)

Chef de délégation / Team Leader : WRONSKI, Andrzej
ZBIGNIEW, Grudzien



Liste des Engagés par pays / Entry-List By Country

Sitetalk Wrestling World Championships



STYLE GR

Entraîneur / Coach :	ORDACK, Artur
	WOLNY, Ryszard
	ZAWADZKI, Włodzimierz
	ABDUSALAMOV, Yusup
Médecin / Medical Staff :	JAKUBOWSKI, Adam
Kiné / Medical Staff :	MARCIN, Krzysztozek
Lutteur(s) / Wrestler(s) :	
120 kg	BLONSKI, Kamil
55 kg	ERSETIC, Dawid Andrzej
60 kg	BARSEGJAN, Edward
66 kg	KARECINSKI, Dawid
74 kg	PRZEPIORKA, Piotr Robert
84 kg	JANIKOWSKI, Damian
96 kg	GRZYBICKI, Radoslaw Pawel

PORTUGAL (POR)

Chef de délégation / Team Leader :	SILVA, Pedro
Entraîneur / Coach :	MAIA, David
Lutteur(s) / Wrestler(s) :	
60 kg	MONIZ, Ruben

ROMANIA (ROU)

Chef de délégation / Team Leader :	RAZVAN LUCIAN, Pircalabu
Entraîneur / Coach :	ALEXANDRU, Constantin
Lutteur(s) / Wrestler(s) :	
60 kg	MUNTEANU, Virgil
66 kg	CARPEN, Georgian
74 kg	PUSCASU, Ionel
84 kg	PIRVAN, Dorin Constantin
96 kg	ALEXUC-CIURARIU, Alin

RUSSIA (RUS)

Chef de délégation / Team Leader :	FADZAEV, Arsen
	ALEXANDRIDIS, Christakis
Entraîneur / Coach :	IVANCHENKO, Mikhail
	KAPAEV, Valeriy
	KUMARITOV, Vadim
	MENSHCHIKOV, Alexander



Liste des Engagés par pays / Entry-List By Country

Sitetalk Wrestling World Championships



STYLE GR

IVANOV, Igor
KADILOV, David
KEZEVADZE, Levani
BOKTAEV, Basang
TSEBOEV, Vladislav
MAGONEDOV, Khadzimurad
BAGAEV, Slavik
UMAROV, Zhaa
SAZHIDOV, Sazhid
TEDEEV, Dzambolat
ZIRATOV, Rasid
MARGIEV, Anatolii
MINTULAEV, Olkhuzur
RASHIDOV, Shamil
MAGOMEDOV, Magomed
TEBIEV, Umar
KOROLIOV, Evgeny
BESTAEV, Gvineriy

Médecin / Medical Staff :

Kiné / Medical Staff :

Lutteur(s) / Wrestler(s) :

120 kg	ANDRUSIK, Sergey
55 kg	TATARINOV, Ivan
60 kg	KUYLAKOV, Ivan
66 kg	ALBIEV, Islam-Beka
74 kg	VLASOV, Roman
84 kg	MISHIN, Aleksey
96 kg	MELNIKOV, Nikita

SERBIA (SRB)

Lutteur(s) / Wrestler(s) :

60 kg	FRIS, Kristijan
66 kg	MAKSIMOVIC, Aleksandar
74 kg	NEMES, Viktor
96 kg	FRANKOVIC, Dejan

SLOVAKIA (SVK)

Entraîneur / Coach :

LENGYEL, Karol
FERNYAK, Stefan

Lutteur(s) / Wrestler(s) :



Liste des Engagés par pays / Entry-List By Country

Sitetalk Wrestling World Championships



STYLE GR

60 kg	LEVAI, Istvan
66 kg	LEVAI, Attila
74 kg	RIGO, Richard
96 kg	LENGYEL, David

SLOVENIA (SLO)

Entraîneur / Coach : BACIC, Rade

Lutteur(s) / Wrestler(s) :

84 kg KUHAR, Jure

SOUTH KOREA (KOR)

Chef de délégation / Team Leader : KIM, Kyunghwan
CHUNG, Nakkyu
KANG, Keunghwan

Entraîneur / Coach : PARK, Chiho
AN, Hanbong

Médecin / Medical Staff : KIM, Deokwon

Kiné / Medical Staff : KIM, Youngil

Lutteur(s) / Wrestler(s) :

120 kg HWANG , Jongwon
55 kg CHOI, Gyujin
60 kg WOO, Seung-Jae
66 kg RYU, Han-Su
74 kg KIM , Hyeonwoo
96 kg LIM, Jiyoung

SPAIN (ESP)

Chef de délégation / Team Leader : IGLESIAS, Francisco Javier

Entraîneur / Coach : SANCHEZ, Oscar

Lutteur(s) / Wrestler(s) :

66 kg NAVARRO SANCHEZ, Ismael
84 kg GARCIA PEREZ, Pedro Jacinto

SWEDEN (SWE)

Chef de délégation / Team Leader : PERSSON, Christer

Entraîneur / Coach : BABULFATH, Mohammad
JANSONS, Zigmunds



Liste des Engagés par pays / Entry-List By Country

Sitetalk Wrestling World Championships



STYLE GR

Kiné / Medical Staff : GANNBY, Ingemar

Lutteur(s) / Wrestler(s) :

120 kg	EUREN, Johan Magnus
55 kg	FAGERLUND, Bo Erik Joakim
60 kg	HARUTYUNYAN, Frunze
66 kg	VARDANYAN, Sharur
74 kg	ROSENGREN, Robert Patrik
84 kg	ZAHITI, Fisnik
96 kg	SCHON, Carl Fredrik Stefan

SWITZERLAND (SUI)

Chef de délégation / Team Leader : KUNG, Ludwig

Entraîneur / Coach : MALTSEV, Andriy

Lutteur(s) / Wrestler(s) :

74 kg	BOSSERT, Jonas
-------	----------------

TAIPEI CHINESE (TPE)

Lutteur(s) / Wrestler(s) :

66 kg	KAO, Shih-Min
-------	---------------

TAJIKISTAN (TJK)

Chef de délégation / Team Leader : SALAMSHO, Mukhabbatov

Entraîneur / Coach : HOMIDOV, Murod

Kiné / Medical Staff : SIRODJEV, Eshon

Lutteur(s) / Wrestler(s) :

120 kg	TUYCHIEV, Murodjon
96 kg	ABDULOEV, Khabibullo

TUNISIA (TUN)

Chef de délégation / Team Leader : BACH HAMBA, Amor

Entraîneur / Coach : AYARI, Omran

Lutteur(s) / Wrestler(s) :

120 kg	CHEBBI, Radhouane
--------	-------------------

TURKEY (TUR)



Liste des Engagés par pays / Entry-List By Country

Sitetalk Wrestling World Championships



STYLE GR

Chef de délégation / Team Leader : YERLIKAYA, Hamza
AKBAS, Oktay
YASAR, Hasan Huseyin

Entraîneur / Coach : BASAR, Hakki
BUNYAMIN, Emik
MUTTALIP, Yerlikaya
SERKAN, Ozden

Médecin / Medical Staff : KIRMIZI, Ã–mer

Kiné / Medical Staff : AKSAKAL, Suat

MECNUN, Pasoli

Lutteur(s) / Wrestler(s) :

120 kg	KAYAALP, Riza
55 kg	UCUNCU, Fatih
60 kg	MEVLUT, Aryk
66 kg	ATAKAN, Yuksel
74 kg	KUS, Emrah
84 kg	CEBI, Selcuk
96 kg	ILDEM, Cenk

UKRAINE (UKR)

Chef de délégation / Team Leader : KHARENKO, Dina

Entraîneur / Coach : DZIGASOV, Artur
CHERTKOV, Yevgeni
BENYAMINOV, Zair
DANKO, Grygorii

Médecin / Medical Staff : SHVANGYRADZE, Merab

Kiné / Medical Staff : BORODKOV, Sergiy

Lutteur(s) / Wrestler(s) :

120 kg	CHERNETSKYY, Oleksandr
55 kg	RAGYMOV, Vyugar
60 kg	TSYMBALIUK, Dmytro
66 kg	DZAKAIEV, Alan
74 kg	DARAGAN, Mykola
84 kg	RACHYBA, Vasyl
96 kg	TIMCHENKO, Dimitriy

UNITED STATES (USA)

Chef de délégation / Team Leader : KIEBLESZ, Paul
KELLEY, Christina



Liste des Engagés par pays / Entry-List By Country

Sitetalk Wrestling World Championships



STYLE GR

Entraîneur / Coach :	LINDLAND, Matt
	FRASER, Steve
	CHANDLER, Dan
Médecin / Medical Staff :	ROBERTO, Fred
	BOSWELL, Randy
	WHIREN, Tony
	RICE, Erika
	DR. FELDMANN, Bernie
Kiné / Medical Staff :	POITIER, Cyrus
Lutteur(s) / Wrestler(s) :	
120 kg	SMITH, Robert Timothy David
55 kg	MANGO, Spenser Thomas
60 kg	THIELKE, Jesse David
66 kg	COLEMAN, Ellis
74 kg	BISEK, Andrew Thomas
84 kg	HOLM, Jordan Robert
96 kg	WILLIAMS, Caylor Ryan

URUGUAY (URU)

Chef de délégation / Team Leader :	DANTE, Steffano
Lutteur(s) / Wrestler(s) :	
120 kg	MELO BAROLI, Juan Pablo

UZBEKISTAN (UZB)

Entraîneur / Coach :	BIKTYAKOV, Ravil
	DAVYDIAN, Nelson
Médecin / Medical Staff :	ABAEVA, Elena
Lutteur(s) / Wrestler(s) :	
60 kg	TASMURADOV, Elmurat
66 kg	KHOLMUKHAMMATOV, Nurbek
74 kg	MURODOV, Azizbek
84 kg	ASSAKALOV, Rustam
96 kg	FATTOEV, Sukhrob

VENEZUELA (VEN)

Chef de délégation / Team Leader :	VALBUANA, Norman
Entraîneur / Coach :	DIAZ, Jose
	VAZQUEZ, Alberto



Liste des Engagés par pays / Entry-List By Country

Sitetalk Wrestling World Championships

STYLE GR



DIAZ MIERES, Jose Alberto

DIAZ, Edward

Médecin / Medical Staff :

VASQUEZ MAIZO, Jhony Sneidel

Lutteur(s) / Wrestler(s) :

120 kg

CAMACARO, Juan

55 kg

MEDINA GARCIA, Jairo Luis

60 kg

RODRIGUEZ OROZCO, Raiber Jose

74 kg

AVENDANO ROJAS, Luis Eduardo

84 kg

BRAZON BRAVO, Alexander Jose

96 kg

CARABALLO CABRERA, Erwin Jose

VIETNAM (VIE)

Chef de délégation / Team Leader :

NGUYEN, The Long

Entraîneur / Coach :

DOI, Dang Hy

TRAN, Van Son

Lutteur(s) / Wrestler(s) :

55 kg

DOI, Dang Tien



Feuille de compétition / Competition Sheet

Sitetalk Wrestling World Championships



STYLE : GR 120 kg

QUALIFICATION			1/8 FINALE			1/4 FINALE			1/2 FINALE			FINALE		
1	GARCIA GARCIA R. (DOM)		1	4	DOM	1	0	DOM	3	0	HUN	6	0	EST
				7			5			0			0	
2	MELO BAROLI J. (URU)		2	0	URU	6	3	EST	6	3	EST	26	3	IRI
										6			4	
3	DEAK-BARDOS Mihaly (HUN)		3	5	HUN	11	4	KAZ	12	1	TUR	26	3	IRI
				4			8			1			4	
4	METODIEV M. (BUL)		4	0	BUL	12	4	TUR	12	4	TUR	26	4	IRI
				1			7			7			7	
5	MEHRALIYEV Zaur (AZE)		5	0	AZE	16	0	BLR	19	0	USA	26	4	IRI
										0			7	
6	NABI Heiki (EST)		6	3	EST	19	3	USA	21	0	GER	26	3	IRI
										0			4	
7	BLONSKI Kamil (POL)		8	0	TUN	21	3	GER	21	0	GER	26	4	IRI
										0			7	
8	CHEBBI Radhouane (TUN)		11	4	KAZ	23	1	GEO	23	1	GEO	26	3	IRI
				8			4			4			4	
9	MAEKAWA Shori (JPN)		12	3	TUR	25	0	SWE	25	0	SWE	26	3	IRI
										0			4	
10	TUYCHIEV Murodjon (TJK)		14	0	RUS	26	4	IRI	26	4	IRI	26	4	IRI
										0			7	
11	TINALIYEV N. (KAZ)		16	3	TUR	26	4	IRI	26	4	IRI	26	4	IRI
										0			7	
12	KAYAALP Riza (TUR)		19	3	USA	26	4	IRI	26	4	IRI	26	4	IRI
										0			7	
13	NAVEEN - (IND)		21	3	GER	26	4	IRI	26	4	IRI	26	4	IRI
										0			7	
14	ANDRUSIK Sergey (RUS)		23	1	GEO	26	4	IRI	26	4	IRI	26	4	IRI
										0			7	
15	CAMACARO Juan (VEN)		25	0	SWE	26	4	IRI	26	4	IRI	26	4	IRI
										0			7	
16	CHUGOSHVILI Ioseb (BLR)		26	4	IRI	26	4	IRI	26	4	IRI	26	4	IRI
										0			7	
17	HWANG Jongwon (KOR)		26	4	IRI	26	4	IRI	26	4	IRI	26	4	IRI
										0			7	
18	NIE Xiaoming (CHN)		26	4	IRI	26	4	IRI	26	4	IRI	26	4	IRI
										0			7	
19	SMITH R. (USA)		26	4	IRI	26	4	IRI	26	4	IRI	26	4	IRI
										0			7	
20	YEGHIAZARYAN V. (ARM)		26	4	IRI	26	4	IRI	26	4	IRI	26	4	IRI
										0			7	
21	POPP Eduard (GER)		26	4	IRI	26	4	IRI	26	4	IRI	26	4	IRI
										0			7	
22	MIZGAITIS M. (LTU)		26	4	IRI	26	4	IRI	26	4	IRI	26	4	IRI
										0			7	
23	ARABULI Levan (GEO)		26	4	IRI	26	4	IRI	26	4	IRI	26	4	IRI
										0			7	
24	ALGHADHRI A. (IRQ)		26	4	IRI	26	4	IRI	26	4	IRI	26	4	IRI
										0			7	
25	EUREN Johan Magnus (SWE)		26	4	IRI	26	4	IRI	26	4	IRI	26	4	IRI
										0			7	
26	ALIAKBARI A. (IRI)		26	4	IRI	26	4	IRI	26	4	IRI	26	4	IRI
										0			7	
27	CHERNETSKYY O. (UKR)		26	4	IRI	26	4	IRI	26	4	IRI	26	4	IRI
										0			7	

26 ALIAKBARI A. (IRI)

Classement

Cl	Pays	Nom
1	IRI	ALIAKBARI Amir Aziz
2	EST	NABI Heiki
3	KAZ	TINALIYEV Nurmakhan
3	TUR	KAYAALP Riza
5	HUN	DEAK-BARDOS Mihaly
5	SWE	EUREN Johan Magnus
7	USA	SMITH Robert Timothy David
8	GER	POPP Eduard
9	TUN	CHEBBI Radhouane
10	DOM	GARCIA GARCIA Ramon Antonio
11	RUS	ANDRUSIK Sergey
12	GEO	ARABULI Levan
13	BLR	CHUGOSHVILI Ioseb
14	POL	BLONSKI Kamil
15	LTU	MIZGAITIS Mindaugas
16	UKR	CHERNETSKYY Oleksandr
17	CHN	NIE Xiaoming
18	JPN	MAEKAWA Shori
19	BUL	METODIEV Miloslav Yuriev
20	ARM	YEGHIAZARYAN Vachik
21	IND	NAVEEN -
22	KOR	HWANG Jongwon
23	URU	MELO BAROLI Juan Pablo
23	AZE	MEHRALIYEV Zaur
23	TJK	TUYCHIEV Murodjon
23	VEN	CAMACARO Juan
27	IRQ	ALGHADHRI Ali Nadhim S

REPECHAGE

REPECHAGE FINALISTE 1

7	3	POL	7	0	POL	11	3	KAZ
	4			0			5	
5	0	AZE	11	4	KAZ	3	0	HUN
	0			8			0	

11 TINALIYEV N. (KAZ)

Mdaille de Bronze

REPECHAGE FINALISTE 2

27	1	UKR	25	3	SWE	25	0	SWE
	2			1			0	
25	3	SWE	21	0	GER	12	3	TUR
	7			0			3	

12 KAYAALP Riza (TUR)

Mdaille de Bronze



Classement

Sitetalk Wrestling World Championships

STYLE : GR 120 kg



1 - Or / Gold

ALIAKBARI Amir Aziz

2 - Argent / Silver

NABI Heiki

3 - Bronze



TINALIYEV Nurmakhan

KAYAALP Riza

Classement	Nom - Name	Pays - Country
1	ALIAKBARI Amir Aziz	IRI
2	NABI Heiki	EST
3	TINALIYEV Nurmakhan	KAZ
3	KAYAALP Riza	TUR
5	DEAK-BARDOS Mihaly	HUN
5	EUREN Johan Magnus	SWE
7	SMITH R.	USA
8	POPP Eduard	GER
9	CHEBBI Radhouane	TUN
10	GARCIA GARCIA R.	DOM
11	ANDRUSIK Sergey	RUS
12	ARABULI Levan	GEO
13	CHUGOSHVILI Ioseb	BLR
14	BLONSKI Kamil	POL
15	MIZGAITIS Mindaugas	LTU
16	CHERNETSKYY O.	UKR
17	NIE Xiaoming	CHN
18	MAEKAWA Shori	JPN
19	METHODIEV M.	BUL
20	YEGHIAZARYAN Vachik	ARM
21	NAVEEN -	IND
22	HWANG Jongwon	KOR
23	MELO BAROLI J.	URU
23	MEHRALIYEV Zaur	AZE
23	TUYCHIEV Murodjon	TJK
23	CAMACARO Juan	VEN
27	ALGHADHRI A.	IRQ



Feuille de compétition / Competition Sheet

Sitetalk Wrestling World Championships



STYLE : GR 55 kg

QUALIFICATION				1/16 Finale				1/8 FINALE			
1	3/3	TATARINOV Ivan (RUS)	P1 P2 P3 3 0 0	1	5/6	TATARINOV Ivan (RUS)	P1 P2 P3 8 1 0	1	4/7	RUS	P1 P2 P3 7 0 0
	3/3		P1 P2 P3 3 0 0				P1 P2 P3 0 0 0				P1 P2 P3 0 0 0
2	3/3	FAGERLUND B. (SWE)	P1 P2 P3 3 0 0	2	0/0	FAGERLUND B. (SWE)	P1 P2 P3 0 0 0				P1 P2 P3 0 0 0
	3/3		P1 P2 P3 3 0 0				P1 P2 P3 0 0 0				P1 P2 P3 0 0 0
3	3/3	CIOBANU Victor (MDA)	P1 P2 P3 3 0 0	3	5/6	CIOBANU Victor (MDA)	P1 P2 P3 8 0 0	3	0/0	MDA	P1 P2 P3 0 0 0
	3/3		P1 P2 P3 3 0 0				P1 P2 P3 0 0 0				P1 P2 P3 0 0 0
4	3/3	KOSTADINOV A. (BUL)	P1 P2 P3 3 0 0	4	0/3	KOSTADINOV A. (BUL)	P1 P2 P3 3 0 0				P1 P2 P3 0 0 0
	3/3		P1 P2 P3 3 0 0				P1 P2 P3 0 0 0				P1 P2 P3 0 0 0
5	3/3	GAURAV Sharma (IND)	P1 P2 P3 3 0 0	5	4/8	GAURAV Sharma (IND)	P1 P2 P3 8 0 0	5	0/0	IND	P1 P2 P3 0 0 0
	3/3		P1 P2 P3 3 0 0				P1 P2 P3 0 0 0				P1 P2 P3 0 0 0
6	3/3	KARATHANASIS L. (GRE)	P1 P2 P3 3 0 0	6	0/0	KARATHANASIS L. (GRE)	P1 P2 P3 0 0 0				P1 P2 P3 0 0 0
	3/3		P1 P2 P3 3 0 0				P1 P2 P3 0 0 0				P1 P2 P3 0 0 0
7	3/3	UCUNCU Fatih (TUR)	P1 P2 P3 3 0 0	7	0/0	UCUNCU Fatih (TUR)	P1 P2 P3 0 0 0				P1 P2 P3 0 0 0
	3/3		P1 P2 P3 3 0 0				P1 P2 P3 0 0 0				P1 P2 P3 0 0 0
8	3/3	AHMADOV Orkhan (AZE)	P1 P2 P3 3 0 0	8	3/4	AHMADOV Orkhan (AZE)	P1 P2 P3 4 0 0	8	4/8	AZE	P1 P2 P3 8 0 0
	3/3		P1 P2 P3 3 0 0				P1 P2 P3 0 0 0				P1 P2 P3 0 0 0
9	3/3	LIZATOVIC Ivan (CRO)	P1 P2 P3 3 0 0	9	0/0	LIZATOVIC Ivan (CRO)	P1 P2 P3 0 0 0	10	4/7	PRK	P1 P2 P3 7 0 0
	3/3		P1 P2 P3 3 0 0				P1 P2 P3 0 0 0				P1 P2 P3 0 0 0
10	3/3	YUN Won Chol (PRK)	P1 P2 P3 3 0 0	10	4/8	YUN Won Chol (PRK)	P1 P2 P3 8 0 0				P1 P2 P3 0 0 0
	3/3		P1 P2 P3 3 0 0				P1 P2 P3 0 0 0				P1 P2 P3 0 0 0
11	3/3	HOEGLMEIER L. (GER)	P1 P2 P3 3 0 0	11	4/8	HOEGLMEIER L. (GER)	P1 P2 P3 8 0 0	11	0/0	GER	P1 P2 P3 0 0 0
	3/3		P1 P2 P3 3 0 0				P1 P2 P3 0 0 0				P1 P2 P3 0 0 0
12	3/3	NOVAK Michal (CZE)	P1 P2 P3 3 0 0	12	1/2	NOVAK Michal (CZE)	P1 P2 P3 2 0 0				P1 P2 P3 0 0 0
	3/3		P1 P2 P3 3 0 0				P1 P2 P3 0 0 0				P1 P2 P3 0 0 0
13	3/3	RONNINGEN T. (NOR)	P1 P2 P3 3 0 0	13	3/4	RONNINGEN T. (NOR)	P1 P2 P3 4 0 0	13	1/2	NOR	P1 P2 P3 2 0 0
	3/3		P1 P2 P3 3 0 0				P1 P2 P3 0 0 0				P1 P2 P3 0 0 0
14	3/3	ZEINALOV Anar (EST)	P1 P2 P3 3 0 0	14	1/2	ZEINALOV Anar (EST)	P1 P2 P3 2 0 0				P1 P2 P3 0 0 0
	3/3		P1 P2 P3 3 0 0				P1 P2 P3 0 0 0				P1 P2 P3 0 0 0
15	3/3	FAGHIRI M. (IRI)	P1 P2 P3 3 0 0	15	1/8	FAGHIRI M. (IRI)	P1 P2 P3 8 0 0	16	3/2	HUN	P1 P2 P3 2 0 0
	3/3		P1 P2 P3 3 0 0				P1 P2 P3 0 0 0				P1 P2 P3 0 0 0
16	3/3	MODOS Peter (HUN)	P1 P2 P3 3 0 0	16	4/10	MODOS Peter (HUN)	P1 P2 P3 10 0 0				P1 P2 P3 0 0 0
	3/3		P1 P2 P3 3 0 0				P1 P2 P3 0 0 0				P1 P2 P3 0 0 0
17	3/3	MEDINA GARCIA J. (VEN)	P1 P2 P3 3 0 0	17	0/0	MEDINA GARCIA J. (VEN)	P1 P2 P3 0 0 0	18	5/4	KGZ	P1 P2 P3 4 0 0
	3/3		P1 P2 P3 3 0 0				P1 P2 P3 0 0 0				P1 P2 P3 0 0 0
18	3/3	ZHOLCHUBEKOV K. (KGZ)	P1 P2 P3 3 0 0	18	3/6	ZHOLCHUBEKOV K. (KGZ)	P1 P2 P3 6 0 0				P1 P2 P3 0 0 0
	3/3		P1 P2 P3 3 0 0				P1 P2 P3 0 0 0				P1 P2 P3 0 0 0
19	3/3	DOI Dang Tien (VIE)	P1 P2 P3 3 0 0	19	0/0	DOI Dang Tien (VIE)	P1 P2 P3 0 0 0	20	0/3	JPN	P1 P2 P3 3 0 0
	3/3		P1 P2 P3 3 0 0				P1 P2 P3 0 0 0				P1 P2 P3 0 0 0
20	3/3	TANOKURA Shota (JPN)	P1 P2 P3 3 0 0	20	4/7	TANOKURA Shota (JPN)	P1 P2 P3 7 0 0				P1 P2 P3 0 0 0
	3/3		P1 P2 P3 3 0 0				P1 P2 P3 0 0 0				P1 P2 P3 0 0 0
21	3/3	MANGO S. (USA)	P1 P2 P3 3 0 0	21	3/4	MANGO S. (USA)	P1 P2 P3 4 0 0	21	1/2	USA	P1 P2 P3 2 0 0
	3/3		P1 P2 P3 3 0 0				P1 P2 P3 0 0 0				P1 P2 P3 0 0 0
22	3/3	HAAPAMÄKI J. (FIN)	P1 P2 P3 3 0 0	22	0/0	HAAPAMÄKI J. (FIN)	P1 P2 P3 0 0 0				P1 P2 P3 0 0 0
	3/3		P1 P2 P3 3 0 0				P1 P2 P3 0 0 0				P1 P2 P3 0 0 0
23	3/3	FAJARI Fouad (MAR)	P1 P2 P3 3 0 0	23	0/0	FAJARI Fouad (MAR)	P1 P2 P3 0 0 0	24	3/4	KOR	P1 P2 P3 4 0 0
	3/3		P1 P2 P3 3 0 0				P1 P2 P3 0 0 0				P1 P2 P3 0 0 0
24	3/3	CHOI Gyujin (KOR)	P1 P2 P3 3 0 0	24	4/8	CHOI Gyujin (KOR)	P1 P2 P3 8 0 0				P1 P2 P3 0 0 0
	3/3		P1 P2 P3 3 0 0				P1 P2 P3 0 0 0				P1 P2 P3 0 0 0
25	3/3	PUTKARADZE Bachana (GEO)	P1 P2 P3 3 0 0	25	0/0	PUTKARADZE Bachana (GEO)	P1 P2 P3 0 0 0	26	1/1	EGY	P1 P2 P3 1 0 0
	3/3		P1 P2 P3 3 0 0				P1 P2 P3 0 0 0				P1 P2 P3 0 0 0
26	3/3	FAHMY MAHMOUD H. (EGY)	P1 P2 P3 3 0 0	26	4/8	FAHMY MAHMOUD H. (EGY)	P1 P2 P3 8 0 0				P1 P2 P3 0 0 0
	3/3		P1 P2 P3 3 0 0				P1 P2 P3 0 0 0				P1 P2 P3 0 0 0
27	3/3	ERSETIC D. (POL)	P1 P2 P3 3 0 0	27	0/0	ERSETIC D. (POL)	P1 P2 P3 0 0 0	28	4/9	KAZ	P1 P2 P3 9 0 0
	3/3		P1 P2 P3 3 0 0				P1 P2 P3 0 0 0				P1 P2 P3 0 0 0
28	3/3	KALMURZAYEV N. (KAZ)	P1 P2 P3 3 0 0	28	3/6	KALMURZAYEV N. (KAZ)	P1 P2 P3 6 0 0				P1 P2 P3 0 0 0
	3/3		P1 P2 P3 3 0 0				P1 P2 P3 0 0 0				P1 P2 P3 0 0 0
29	3/3	BAO Liri (CHN)	P1 P2 P3 3 0 0	29	0/2	BAO Liri (CHN)	P1 P2 P3 2 0 0	30	0/0	UKR	P1 P2 P3 0 0 0
	3/3		P1 P2 P3 3 0 0				P1 P2 P3 0 0 0				P1 P2 P3 0 0 0
30	3/3	RAGYMOV Vyugar (UKR)	P1 P2 P3 3 0 0	30	5/5	RAGYMOV Vyugar (UKR)	P1 P2 P3 5 0 0				P1 P2 P3 0 0 0
	3/3		P1 P2 P3 3 0 0				P1 P2 P3 0 0 0				P1 P2 P3 0 0 0
31	3/3	AMOYAN Roman (ARM)	P1 P2 P3 3 0 0	31	3/4	AMOYAN Roman (ARM)	P1 P2 P3 4 0 0	31	4/7	ARM	P1 P2 P3 7 0 0
	3/3		P1 P2 P3 3 0 0				P1 P2 P3 0 0 0				P1 P2 P3 0 0 0
32	0/0	NOVAS FELIZ C. (DOM)	P1 P2 P3 0 0 0	33	0/0	TAZHYYEU Elbek (BLR)	P1 P2 P3 0 0 0				P1 P2 P3 0 0 0
	3/3		P1 P2 P3 0 0 0				P1 P2 P3 0 0 0				P1 P2 P3 0 0 0
33	4/7	TAZHYYEU Elbek (BLR)	P1 P2 P3 7 0 0				P1 P2 P3 0 0 0				P1 P2 P3 0 0 0



Feuille de compétition / Competition Sheet

Sitewrestling World Championships

STYLE : GR 55 kg



Classement

Cl	Pays	Nom
1	PRK	YUN Won Chol
2	KOR	CHOI Gyujin
3	HUN	MODOS Peter
3	ARM	AMOYAN Roman
5	RUS	TATARINOV Ivan
5	USA	MANGO Spenser Thomas
7	KGZ	ZHOLCHUBEKOV Kanybek
8	AZE	AHMADOV Orkhan
9	KAZ	KALMURZAYEV Nursultan
10	MDA	CIOBANU Victor
11	UKR	RAGYMOV Vyugar
12	EGY	FAHMY MAHMOUD Haithem Ahmed
13	GER	HOEGLMEIER Lukas Hilmar
14	JPN	TANOKURA Shota
15	IND	GAURAV Sharma
16	CRO	LIZATOVIC Ivan
17	BLR	TAZHYIEU Elbek
18	NOR	RONNINGEN Thomas Andresen
19	IRI	FAGHIRI Mohammad Eynollah
20	EST	ZEINALOV Anar

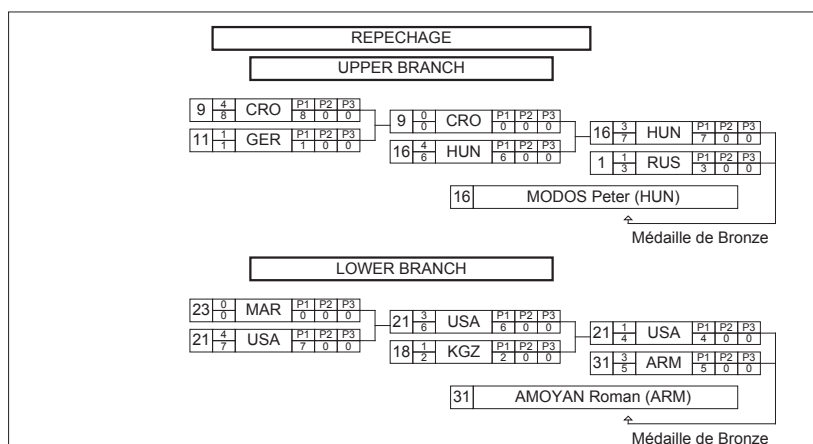



Classement

Sitetalk Wrestling World Championships

STYLE : GR 55 kg



1 - Or / Gold

YUN Won Chol

2 - Argent / Silver

CHOI Gyujin

3 - Bronze

MODOS Peter

AMOYAN Roman

Classement	Nom - Name	Pays - Country
1	YUN Won Chol	PRK
2	CHOI Gyujin	KOR
3	MODOS Peter	HUN
3	AMOYAN Roman	ARM
5	TATARINOV Ivan	RUS
5	MANGO S.	USA
7	ZHOLCHUBEKOV K.	KGZ
8	AHMADOV Orkhan	AZE
9	KALMURZAYEV N.	KAZ
10	CIOBANU Victor	MDA
11	RAGYMOV Vyugar	UKR
12	FAHMY MAHMOUD H.	EGY
13	HOEGLMEIER L.	GER
14	TANOKURA Shota	JPN
15	GAURAV Sharma	IND
16	LIZATOVIC Ivan	CRO
17	TAZHYIEU Elbek	BLR
18	RONNINGEN T.	NOR
19	FAGHIRI M.	IRI
20	ZEINALOV Anar	EST
21	NOVAK Michal	CZE
22	KOSTADINOV A.	BUL
23	BAO Liri	CHN
24	HAAPAMÄKI J.	FIN
24	UCUNCU Fatih	TUR
26	FAGERLUND B.	SWE
26	MEDINA GARCIA J.	VEN
26	ERSETIC D.	POL
29	DOI Dang Tien	VIE
29	NOVAS FELIZ C.	DOM



Classement

Sitetalk Wrestling World Championships

STYLE : GR 55 kg



<i>Classement</i>	<i>Nom - Name</i>	<i>Pays - Country</i>
31	KARATHANASIS L.	GRE
31	PUTKARADZE Bachana	GEO
33	FAJARI Fouad	MAR



Feuille de compétition / Competition Sheet

Sitetalk Wrestling World Championships



STYLE : GR 60 kg

QUALIFICATION				1/16 Finale				1/8 FINALE			
1	3/5	FRIS Kristijan (SRB)	P1 P2 P3 5 0 0	1	5/5	FRIS Kristijan (SRB)	P1 P2 P3 5 0 0	1	0/0	SRB	P1 P2 P3 0 0 0
2	3/5	SOTO Muise (PAN)	P1 P2 P3 5 0 0	2	0/0	SOTO Muise (PAN)	P1 P2 P3 0 0 0	2	4/7	BUL	P1 P2 P3 7 0 0
3	3/5	ANGELOV I. (BUL)	P1 P2 P3 5 0 0	3	4/7	ANGELOV I. (BUL)	P1 P2 P3 7 0 0	3	4/7	BUL	P1 P2 P3 7 0 0
4	3/5	LOPEZ Juan Carlos (COL)	P1 P2 P3 5 0 0	4	0/0	LOPEZ Juan Carlos (COL)	P1 P2 P3 0 0 0	4	1/5	VEN	P1 P2 P3 5 0 0
5	3/5	MONIZ Ruben (POR)	P1 P2 P3 5 0 0	5	1/1	MONIZ Ruben (POR)	P1 P2 P3 1 0 0	5	4/6	RODRIGUEZ OROZCO R. (VEN)	P1 P2 P3 6 0 0
6	3/5	RODRIGUEZ OROZCO R. (VEN)	P1 P2 P3 5 0 0	6	4/6	RODRIGUEZ OROZCO R. (VEN)	P1 P2 P3 6 0 0	6	4/8	BARSEGJAN Edward (POL)	P1 P2 P3 8 0 0
7	3/5	BARSEGJAN Edward (POL)	P1 P2 P3 5 0 0	7	4/8	BARSEGJAN Edward (POL)	P1 P2 P3 8 0 0	7	3/9	POL	P1 P2 P3 9 0 0
8	3/5	RIBEIRO ROMANELLI D. (BRA)	P1 P2 P3 5 0 0	8	0/0	RIBEIRO ROMANELLI D. (BRA)	P1 P2 P3 0 0 0	8	5/6	USA	P1 P2 P3 6 0 0
9	3/5	THIELKE J. (USA)	P1 P2 P3 5 0 0	9	4/9	THIELKE J. (USA)	P1 P2 P3 9 0 0	9	1/4	THEODORAKIS C. (GRE)	P1 P2 P3 4 0 0
10	3/5	THEODORAKIS C. (GRE)	P1 P2 P3 5 0 0	10	1/4	THEODORAKIS C. (GRE)	P1 P2 P3 4 0 0	10	5/3	RAVINDER Singh (IND)	P1 P2 P3 3 0 0
11	3/5	RAVINDER Singh (IND)	P1 P2 P3 5 0 0	11	5/3	RAVINDER Singh (IND)	P1 P2 P3 3 0 0	11	0/6	KALABAEYU Erbol (BLR)	P1 P2 P3 6 0 0
12	3/5	KALABAEYU Erbol (BLR)	P1 P2 P3 5 0 0	12	0/6	KALABAEYU Erbol (BLR)	P1 P2 P3 6 0 0	12	1/3	ZHOU Jingjie (CHN)	P1 P2 P3 3 0 0
13	3/5	ZHOU Jingjie (CHN)	P1 P2 P3 5 0 0	13	1/3	ZHOU Jingjie (CHN)	P1 P2 P3 3 0 0	13	3/8	SKALS T. (DEN)	P1 P2 P3 8 0 0
14	3/5	SKALS T. (DEN)	P1 P2 P3 5 0 0	14	3/8	SKALS T. (DEN)	P1 P2 P3 8 0 0	14	3/4	WOO Seung-Jae (KOR)	P1 P2 P3 4 0 0
15	3/5	WOO Seung-Jae (KOR)	P1 P2 P3 5 0 0	15	3/4	WOO Seung-Jae (KOR)	P1 P2 P3 4 0 0	15	0/0	MAMMADOV Kamran (AZE)	P1 P2 P3 0 0 0
16	3/5	MAMMADOV Kamran (AZE)	P1 P2 P3 5 0 0	16	0/0	MAMMADOV Kamran (AZE)	P1 P2 P3 0 0 0	16	4/8	BELMADANI Tarik (FRA)	P1 P2 P3 8 0 0
17	3/5	BELMADANI Tarik (FRA)	P1 P2 P3 5 0 0	17	4/8	BELMADANI Tarik (FRA)	P1 P2 P3 8 0 0	17	1/1	LEVAI Istvan (SVK)	P1 P2 P3 1 0 0
18	3/5	LEVAI Istvan (SVK)	P1 P2 P3 5 0 0	18	1/1	LEVAI Istvan (SVK)	P1 P2 P3 1 0 0	18	3/5	HARUTYUNYAN Frunze (SWE)	P1 P2 P3 5 0 0
19	3/5	HARUTYUNYAN Frunze (SWE)	P1 P2 P3 5 0 0	19	3/5	HARUTYUNYAN Frunze (SWE)	P1 P2 P3 5 0 0	19	1/2	ENCARNACION F. (DOM)	P1 P2 P3 2 0 0
20	3/5	ENCARNACION F. (DOM)	P1 P2 P3 5 0 0	20	1/2	ENCARNACION F. (DOM)	P1 P2 P3 2 0 0	20	0/0	MENDEZ HIDALGO V. (MEX)	P1 P2 P3 0 0 0
21	3/5	MENDEZ HIDALGO V. (MEX)	P1 P2 P3 5 0 0	21	0/0	MENDEZ HIDALGO V. (MEX)	P1 P2 P3 0 0 0	21	3/2	MUNTEANU Virgil (ROU)	P1 P2 P3 2 0 0
22	3/5	MUNTEANU Virgil (ROU)	P1 P2 P3 5 0 0	22	3/2	MUNTEANU Virgil (ROU)	P1 P2 P3 2 0 0	22	0/0	MENDIETA FUENTES A. (NCA)	P1 P2 P3 0 0 0
23	3/5	MENDIETA FUENTES A. (NCA)	P1 P2 P3 5 0 0	23	0/0	MENDIETA FUENTES A. (NCA)	P1 P2 P3 0 0 0	23	4/7	KEBISPAYEV Almat (KAZ)	P1 P2 P3 7 0 0
24	3/5	KEBISPAYEV Almat (KAZ)	P1 P2 P3 5 0 0	24	4/7	KEBISPAYEV Almat (KAZ)	P1 P2 P3 7 0 0	24	1/5	TSYMBALIUK Dmytro (UKR)	P1 P2 P3 5 0 0
25	3/5	TSYMBALIUK Dmytro (UKR)	P1 P2 P3 5 0 0	25	1/5	TSYMBALIUK Dmytro (UKR)	P1 P2 P3 5 0 0	25	3/6	TASMURADOV Elmurat (UZB)	P1 P2 P3 6 0 0
26	0/0	MIKAYELIAN Aleksan (ARM)	P1 P2 P3 0 0 0	26	3/6	TASMURADOV Elmurat (UZB)	P1 P2 P3 6 0 0	26	4/7	RUS	P1 P2 P3 7 0 0
27	4/7	KUYLAKOV Ivan (RUS)	P1 P2 P3 7 0 0	27	3/6	KUYLAKOV Ivan (RUS)	P1 P2 P3 6 0 0	27	0/0	DJEDIAIET Mouatez (ALG)	P1 P2 P3 0 0 0
28	1/3	SOKOL Tonimir (CRO)	P1 P2 P3 3 0 0	28	1/3	SOKOL Tonimir (CRO)	P1 P2 P3 3 0 0	28	1/5	MEVLUT Aryk (TUR)	P1 P2 P3 5 0 0
29	4/8	TASMURADOV Elmurat (UZB)	P1 P2 P3 8 0 0	29	3/8	TASMURADOV Elmurat (UZB)	P1 P2 P3 8 0 0	29	0/0	ERALIEV Arsen (KGZ)	P1 P2 P3 0 0 0
30	0/0	DJEDIAIET Mouatez (ALG)	P1 P2 P3 0 0 0	30	0/0	ERALIEV Arsen (KGZ)	P1 P2 P3 0 0 0	30	0/0	MEVLUT Aryk (TUR)	P1 P2 P3 5 0 0
31	5/2	MEVLUT Aryk (TUR)	P1 P2 P3 2 0 0	31	1/5	MEVLUT Aryk (TUR)	P1 P2 P3 5 0 0	31	3/6	BORRERO MOLINA I. (CUB)	P1 P2 P3 6 0 0
32	1/2	ERALIEV Arsen (KGZ)	P1 P2 P3 2 0 0	32	0/0	MEVLUT Aryk (TUR)	P1 P2 P3 5 0 0	32	0/0	MEVLUT Aryk (TUR)	P1 P2 P3 5 0 0
33	3/2	KOZAK Istvan (HUN)	P1 P2 P3 2 0 0	33	0/0	KOZAK Istvan (HUN)	P1 P2 P3 0 0 0	33	1/3	CUB	P1 P2 P3 3 0 0
34	1/2	BERGE Stig-Andre (NOR)	P1 P2 P3 2 0 0	34	0/0	KOZAK Istvan (HUN)	P1 P2 P3 0 0 0	34	3/6	BORRERO MOLINA I. (CUB)	P1 P2 P3 6 0 0
35	3/5	BORRERO MOLINA I. (CUB)	P1 P2 P3 5 0 0	35	3/6	BORRERO MOLINA I. (CUB)	P1 P2 P3 6 0 0	35	4/10	KURAMOTO Kazuma (JPN)	P1 P2 P3 10 0 0
36	5/5	KURAMOTO Kazuma (JPN)	P1 P2 P3 5 0 0	36	4/10	KURAMOTO Kazuma (JPN)	P1 P2 P3 10 0 0	36	0/0	LASHKHI Revaz (GEO)	P1 P2 P3 0 0 0
37	0/0	LASHKHI Revaz (GEO)	P1 P2 P3 0 0 0	37	0/0	LASHKHI Revaz (GEO)	P1 P2 P3 0 0 0	37	0/2	ISLAMOV Donior (MDA)	P1 P2 P3 2 0 0
38	0/2	ISLAMOV Donior (MDA)	P1 P2 P3 2 0 0	38	0/2	ISLAMOV Donior (MDA)	P1 P2 P3 2 0 0	38	1/2	NOURBAKHSH M. (IRI)	P1 P2 P3 2 0 0
39	5/8	NOURBAKHSH M. (IRI)	P1 P2 P3 8 0 0	39	1/2	NOURBAKHSH M. (IRI)	P1 P2 P3 2 0 0	39	4/12	JPN	P1 P2 P3 12 0 0



Feuille de compétition / Competition Sheet

Sitetaik Wrestling World Championships

STYLE : GR 60 kg



Classement

Cl	Pays	Nom
1	BUL	ANGELOV Ivo Serafimov
2	RUS	KUYLAKOV Ivan
3	KOR	WOO Seung-Jae
3	UZB	TASMURADOV Elmurat
5	POL	BARSEGJAN Edward
5	KAZ	KEBISPAYEV Almat
7	JPN	KURAMOTO Kazuma
8	USA	THIELKE Jesse David
9	SRB	FRIS Kristijan
10	FRA	BELMADANI Tarik
11	CUB	BORRERO MOLINA Ismael
12	IRI	NOURBAKHSH Mohammad Naser
13	UKR	TSYMBALIUK Dmytro
14	TUR	MEVLUT Aryk
15	IND	RAVINDER Singh
16	VEN	RODRIGUEZ OROZCO Raiber Jose
17	DEN	SKALS Tobias Fannesbek
18	SWE	HARUTYUNYAN Frunze
19	ROU	MUNTEANU Virgil
20	HUN	KOZAK Istvan

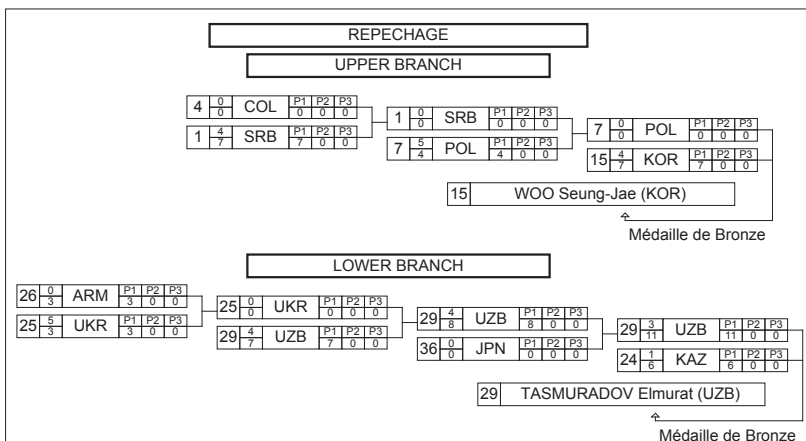

**Classement****Sitetalk Wrestling World Championships**

STYLE : GR 60 kg

**1 - Or / Gold**

ANGELOV Ivo Serafimov

2 - Argent / Silver

KUYLAKOV Ivan

3 - Bronze

WOO Seung-Jae

TASMURADOV Elmurat

Classement	Nom - Name	Pays - Country
1	ANGELOV I.	BUL
2	KUYLAKOV Ivan	RUS
3	WOO Seung-Jae	KOR
3	TASMURADOV Elmurat	UZB
5	BARSEGJAN Edward	POL
5	KEBISPAYEV Almat	KAZ
7	KURAMOTO Kazuma	JPN
8	THIELKE Jesse David	USA
9	FRIS Kristijan	SRB
10	BELMADANI Tarik	FRA
11	BORRERO MOLINA I.	CUB
12	NOURBAKSH M.	IRI
13	TSYMBALIUK Dmytro	UKR
14	MEVLUT Aryk	TUR
15	RAVINDER Singh	IND
16	RODRIGUEZ OROZCO R.	VEN
17	SKALS T.	DEN
18	HARUTYUNYAN Frunze	SWE
19	MUNTEANU Virgil	ROU
20	KOZAK Istvan	HUN
21	THEODORAKIS C.	GRE
22	SOKOL Tonimir	CRO
22	ZHOU Jingjie	CHN
24	ERALIEV Arsen	KGZ
25	BERGE Stig-Andre	NOR
25	ENCARNACION F.	DOM
27	MONIZ Ruben	POR
28	LEVAI Istvan	SVK
29	KALABAEYU Erbol	BLR
30	MIKAYELIAN Aleksan	ARM

**Classement****Sitetalk Wrestling World Championships**

STYLE : GR 60 kg



Classement	Nom - Name	Pays - Country
31	ISLAMOV Donior	MDA
32	DJEDAIET Mouatez	ALG
32	MENDEZ HIDALGO V.	MEX
34	MAMMADOV Kamran	AZE
35	LASHKHI Revaz	GEO
35	SOTO Muise	PAN
37	MENDIETA FUENTES A.	NCA
38	RIBEIRO ROMANELLI D.	BRA
39	LOPEZ Juan Carlos	COL



Feuille de compétition / Competition Sheet

Sitetalk Wrestling World Championships



STYLE : GR 66 kg

QUALIFICATION				1/16 Finale				1/8 FINALE			
1	1/8	MEJIA SAMBULA J. (HON)	P1 P2 P3 6 0 0	1	4/8	MEJIA SAMBULA J. (HON)	P1 P2 P3 6 0 0	1	1/7	HON	P1 P2 P3 7 0 0
2	1/8	KAO Shih-Min (TPE)	P1 P2 P3 6 0 0	2	0/0	KAO Shih-Min (TPE)	P1 P2 P3 0 0 0	2	3/10	GRE	P1 P2 P3 10 0 0
3	1/8	LOPEZ JR J. (GUM)	P1 P2 P3 6 0 0	3	0/0	LOPEZ JR J. (GUM)	P1 P2 P3 0 0 0	3	1/4	COL	P1 P2 P3 4 0 0
4	1/8	MATIAS Vladimiro (GRE)	P1 P2 P3 6 0 0	4	4/8	MATIAS Vladimiro (GRE)	P1 P2 P3 6 0 0	4	4/11	SRB	P1 P2 P3 11 0 0
5	1/8	DA SILVA FEITOSA A. (BRA)	P1 P2 P3 6 0 0	5	0/0	DA SILVA FEITOSA A. (BRA)	P1 P2 P3 0 0 0	5	5/4	MDA	P1 P2 P3 4 0 0
6	1/8	CUERO Alexis (COL)	P1 P2 P3 6 0 0	6	4/8	CUERO Alexis (COL)	P1 P2 P3 6 0 0	6	0/2	CARPEN Georgian (ROU)	P1 P2 P3 2 0 0
7	1/8	PUFFER Benedikt (AUT)	P1 P2 P3 6 0 0	7	0/0	PUFFER Benedikt (AUT)	P1 P2 P3 0 0 0	7	0/0	NAVARRO SANCHEZ I. (ESP)	P1 P2 P3 0 0 0
8	1/8	MAKSIMOVIC A. (SRB)	P1 P2 P3 6 0 0	8	4/7	MAKSIMOVIC A. (SRB)	P1 P2 P3 7 0 0	8	4/6	IND	P1 P2 P3 6 0 0
9	1/8	COSNICEANU Mihail (MDA)	P1 P2 P3 6 0 0	9	5/4	COSNICEANU Mihail (MDA)	P1 P2 P3 4 0 0	9	1/1	CZE	P1 P2 P3 1 0 0
10	1/8	CARPEN Georgian (ROU)	P1 P2 P3 6 0 0	10	0/2	CARPEN Georgian (ROU)	P1 P2 P3 2 0 0	10	4/9	KOR	P1 P2 P3 9 0 0
11	1/8	NAVARRO SANCHEZ I. (ESP)	P1 P2 P3 6 0 0	11	0/0	NAVARRO SANCHEZ I. (ESP)	P1 P2 P3 0 0 0	11	3/6	RUS	P1 P2 P3 6 0 0
12	1/8	SANDEEP T. (IND)	P1 P2 P3 6 0 0	12	3/5	SANDEEP T. (IND)	P1 P2 P3 5 0 0	12	4/8	GHAMBARYAN Sasun (ARM)	P1 P2 P3 8 0 0
13	1/8	BENAISSA T. (ALG)	P1 P2 P3 6 0 0	13	0/0	BENAISSA T. (ALG)	P1 P2 P3 0 0 0	13	0/0	PETROV P. (BUL)	P1 P2 P3 0 0 0
14	1/8	MORBITCZER Matous (CZE)	P1 P2 P3 6 0 0	14	4/7	MORBITCZER Matous (CZE)	P1 P2 P3 7 0 0	14	1/2	KONYRATOV Yerbol (KAZ)	P1 P2 P3 2 0 0
15	1/8	VARDANYAN Sharur (SWE)	P1 P2 P3 6 0 0	15	0/0	VARDANYAN Sharur (SWE)	P1 P2 P3 0 0 0	15	3/3	STAEBLER Frank (GER)	P1 P2 P3 3 0 0
16	1/8	RYU Han-Su (KOR)	P1 P2 P3 6 0 0	16	4/7	RYU Han-Su (KOR)	P1 P2 P3 7 0 0	16	3/7	VENCKAITIS Edgaras (LTU)	P1 P2 P3 7 0 0
17	1/8	MULENS HERRERA P. (CUB)	P1 P2 P3 6 0 0	17	0/1	MULENS HERRERA P. (CUB)	P1 P2 P3 1 0 0	17	1/3	SHIMIZHU Hiroyuki (JPN)	P1 P2 P3 3 0 0
18	1/8	ALBIEV Islam-Beka (RUS)	P1 P2 P3 6 0 0	18	5/4	ALBIEV Islam-Beka (RUS)	P1 P2 P3 4 0 0	18	3/5	LORINCZ Tamas (HUN)	P1 P2 P3 5 0 0
19	1/8	GHAMBARYAN Sasun (ARM)	P1 P2 P3 6 0 0	19	4/8	GHAMBARYAN Sasun (ARM)	P1 P2 P3 8 0 0	19	0/0	THOMMESEN M. (NOR)	P1 P2 P3 0 0 0
20	1/8	PETROV P. (BUL)	P1 P2 P3 6 0 0	20	0/0	PETROV P. (BUL)	P1 P2 P3 0 0 0	20	1/2	YAN Pengfei (CHN)	P1 P2 P3 2 0 0
21	1/8	KONYRATOV Yerbol (KAZ)	P1 P2 P3 6 0 0	21	1/2	KONYRATOV Yerbol (KAZ)	P1 P2 P3 2 0 0	21	3/4	DZAKAIEV Alan (UKR)	P1 P2 P3 4 0 0
22	1/8	STAEBLER Frank (GER)	P1 P2 P3 6 0 0	22	3/3	STAEBLER Frank (GER)	P1 P2 P3 3 0 0	22	0/0	LEVAI Attila (SVK)	P1 P2 P3 0 0 0
23	1/8	VENCKAITIS Edgaras (LTU)	P1 P2 P3 6 0 0	23	3/7	VENCKAITIS Edgaras (LTU)	P1 P2 P3 7 0 0	23	1/1	BYABANGARD A. (IRI)	P1 P2 P3 1 0 0
24	1/8	SHIMIZHU Hiroyuki (JPN)	P1 P2 P3 6 0 0	24	1/3	SHIMIZHU Hiroyuki (JPN)	P1 P2 P3 3 0 0	24	0/0	KHOLMUKHAMMATOV N. (UZB)	P1 P2 P3 0 0 0
25	1/8	LORINCZ Tamas (HUN)	P1 P2 P3 6 0 0	25	3/5	LORINCZ Tamas (HUN)	P1 P2 P3 5 0 0	25	0/0	TIUMENBAEV Ruslan (KGZ)	P1 P2 P3 0 0 0
26	3/3	THOMMESEN M. (NOR)	P1 P2 P3 3 0 0	26	0/0	THOMMESEN M. (NOR)	P1 P2 P3 0 0 0	26	3/2	ETLINGER Dominik (CRO)	P1 P2 P3 2 0 0
27	1/2	DAVITAIA Sachino (GEO)	P1 P2 P3 2 0 0	27	0/0	DAVITAIA Sachino (GEO)	P1 P2 P3 0 0 0	27	3/3	ALIYEV Hasan (AZE)	P1 P2 P3 3 0 0
28	1/2	YAN Pengfei (CHN)	P1 P2 P3 2 0 0	28	1/1	DZAKAIEV Alan (UKR)	P1 P2 P3 1 0 0	28	3/6	ATAKAN Yuksel (TUR)	P1 P2 P3 6 0 0
29	3/4	DZAKAIEV Alan (UKR)	P1 P2 P3 4 0 0	29	3/4	BYABANGARD A. (IRI)	P1 P2 P3 4 0 0	29	0/0	COLEMAN Ellis (USA)	P1 P2 P3 0 0 0
30	0/0	LEVAI Attila (SVK)	P1 P2 P3 0 0 0	30	3/4	BYABANGARD A. (IRI)	P1 P2 P3 4 0 0	30	0/0	SIAMIONAU Mikhail (BLR)	P1 P2 P3 0 0 0
31	4/8	BYABANGARD A. (IRI)	P1 P2 P3 8 0 0	31	0/0	TIUMENBAEV Ruslan (KGZ)	P1 P2 P3 0 0 0	31	0/0	KARECINSKI Dawid (POL)	P1 P2 P3 0 0 0
32	1/5	KHOLMUKHAMMATOV N. (UZB)	P1 P2 P3 5 0 0	32	0/0	TIUMENBAEV Ruslan (KGZ)	P1 P2 P3 0 0 0	32	3/3	KARECINSKI Dawid (POL)	P1 P2 P3 3 0 0
33	3/5	TIUMENBAEV Ruslan (KGZ)	P1 P2 P3 5 0 0	33	0/0	TIUMENBAEV Ruslan (KGZ)	P1 P2 P3 0 0 0	33	3/3	KARECINSKI Dawid (POL)	P1 P2 P3 3 0 0
34	0/0	ETLINGER Dominik (CRO)	P1 P2 P3 0 0 0	34	4/7	ALIYEV Hasan (AZE)	P1 P2 P3 7 0 0	34	1/1	KARECINSKI Dawid (POL)	P1 P2 P3 1 0 0
35	3/3	ALIYEV Hasan (AZE)	P1 P2 P3 3 0 0	35	3/6	ATAKAN Yuksel (TUR)	P1 P2 P3 6 0 0	35	1/1	KARECINSKI Dawid (POL)	P1 P2 P3 1 0 0
36	3/2	ATAKAN Yuksel (TUR)	P1 P2 P3 2 0 0	36	3/6	ATAKAN Yuksel (TUR)	P1 P2 P3 6 0 0	36	1/1	KARECINSKI Dawid (POL)	P1 P2 P3 1 0 0
37	1/2	COLEMAN Ellis (USA)	P1 P2 P3 2 0 0	37	0/0	SIAMIONAU Mikhail (BLR)	P1 P2 P3 0 0 0	37	0/0	KARECINSKI Dawid (POL)	P1 P2 P3 0 0 0
38	0/0	SIAMIONAU Mikhail (BLR)	P1 P2 P3 0 0 0	38	0/0	KARECINSKI Dawid (POL)	P1 P2 P3 0 0 0	38	0/0	KARECINSKI Dawid (POL)	P1 P2 P3 0 0 0
39	3/3	KARECINSKI Dawid (POL)	P1 P2 P3 3 0 0	39	0/0	KARECINSKI Dawid (POL)	P1 P2 P3 0 0 0	39	0/0	KARECINSKI Dawid (POL)	P1 P2 P3 0 0 0



Classement

Sitetalk Wrestling World Championships

STYLE : GR 66 kg



1 - Or / Gold

RYU Han-Su

2 - Argent / Silver

ALBIEV Islam-Beka

3 - Bronze



SANDEEP Tulsi Yadan

STAEBLER Frank

Classement	Nom - Name	Pays - Country
1	RYU Han-Su	KOR
2	ALBIEV Islam-Beka	RUS
3	SANDEEP Tulsi Yadan	IND
3	STAEBLER Frank	GER
5	MAKSIMOVIC A.	SRB
5	ALIYEV Hasan	AZE
7	MATIAS Vladimiro	GRE
8	BYABANGARD A.	IRI
9	ATAKAN Yuksel	TUR
10	LORINCZ Tamas	HUN
11	GHAMBARYAN Sasun	ARM
12	COSNICEANU Mihail	MDA
13	MEJIA SAMBULA J.	HON
14	CUERO Alexis	COL
15	VARDANYAN Sharur	SWE
16	MORBITCZER Matous	CZE
17	VENCKAITIS Edgaras	LTU
18	MULENS HERRERA P.	CUB
19	DZAKAIEV Alan	UKR
20	TIUMENBAEV Ruslan	KGZ
21	KARECINSKI Dawid	POL
22	THOMMESEN M.	NOR
23	KHOLMUKHAMMATOV N.	UZB
24	SHIMIZHU Hiroyuki	JPN
25	COLEMAN Ellis	USA
26	DAVITAIA Sachino	GEO
26	KONYRATOV Yerbol	KAZ
28	YAN Pengfei	CHN
29	CARPEN Georgian	ROU
30	SIAMIONAU Mikhail	BLR

**Classement****Sitetalk Wrestling World Championships**

STYLE : GR 66 kg



<i>Classement</i>	<i>Nom - Name</i>	<i>Pays - Country</i>
30	ETLINGER Dominik	CRO
32	NAVARRO SANCHEZ I.	ESP
33	KAO Shih-Min	TPE
34	PUFFER Benedikt	AUT
34	BENAISSA Tarek Aziz	ALG
36	LOPEZ JR J.	GUM
36	DA SILVA FEITOSA A.	BRA
36	PETROV P.	BUL
36	LEVAI Attila	SVK

**Classement****Sitetalk Wrestling World Championships**

STYLE : GR 74 kg

**1 - Or / Gold**

KIM Hyeonwoo

2 - Argent / Silver

VLASOV Roman

3 - Bronze

JULFALAKYAN Arsen

KUS Emrah

Classement	Nom - Name	Pays - Country
1	KIM Hyeonwoo	KOR
2	VLASOV Roman	RUS
3	JULFALAKYAN Arsen	ARM
3	KUS Emrah	TUR
5	MADSEN M.	DEN
5	SUOMINEN V.	FIN
7	DARAGAN Mykola	UKR
8	YANG Bin	CHN
9	KOZHOBEK UULU E.	KGZ
10	HUSEYNOV Rafig	AZE
11	VISNAKOV A.	LAT
12	PRZEPIORKA P.	POL
13	GULBATASHVILI Ilia	GEO
14	YANAKIEV Y.	BUL
15	MURODOV Azizbek	UZB
16	KANAKUBO Takehiro	JPN
17	BISEK Andrew Thomas	USA
18	ESCOBAR Huan Angel	MEX
19	ROSENGREN R.	SWE
20	KAZAKEVIC Aleksandr	LTU
21	BESLEAGA Igor	MDA
22	ZUGAJ Neven	CRO
23	DILMUKHAMEDOV A.	KAZ
24	SAMURGASHEV Rafael	MNE
25	RIGO Richard	SVK
26	KORPASI Balint	HUN
27	MANOUILIDIS Petros	GRE
28	NEMES Viktor	SRB
29	PUSCASU Ionel	ROU
30	DTEMYANOVICH A.	BLR



Classement

Sitetalk Wrestling World Championships

STYLE : GR 74 kg



Classement	Nom - Name	Pays - Country
31	NEUMAIER Florian	GER
32	ALIZADEHPOURNIA H.	IRI
33	RAJBIR Chhikara	IND
34	SOBECKY Tomas	CZE
34	AVENDANO ROJAS L.	VEN
36	BOSSERT Jonas	SUI
36	MARCHL Florian	AUT
38	DAVIES C.	NZL
39	ALMENDRA Alvin	PAN



Feuille de compétition / Competition Sheet

Sitetalk Wrestling World Championships



STYLE : GR 84 kg

QUALIFICATION				1/16 Finale				1/8 FINALE			
1	4/7	PIRVAN D. (ROU)	P1 P2 P3 7 0 0	1	3/2	PIRVAN D. (ROU)	P1 P2 P3 2 0 0	1	0/0	ROU	P1 P2 P3 0 0 0
2	4/7	BEISHEBEKOV Azat (KGZ)	P1 P2 P3 7 0 0	2	0/0	BEISHEBEKOV Azat (KGZ)	P1 P2 P3 0 0 0	2	5/10	ARM	P1 P2 P3 10 0 0
3	4/7	MANUKYAN Maksim (ARM)	P1 P2 P3 7 0 0	3	4/9	MANUKYAN Maksim (ARM)	P1 P2 P3 9 0 0	3	0/0	EST	P1 P2 P3 0 0 0
4	4/7	ABD ELSALAM SHIBL T. (EGY)	P1 P2 P3 7 0 0	4	0/0	ABD ELSALAM SHIBL T. (EGY)	P1 P2 P3 0 0 0	4	4/7	POL	P1 P2 P3 7 0 0
5	4/7	HARPREET Singh (IND)	P1 P2 P3 7 0 0	5	0/0	HARPREET Singh (IND)	P1 P2 P3 0 0 0	5	5/6	IRI	P1 P2 P3 6 0 0
6	4/7	APS Eerik (EST)	P1 P2 P3 7 0 0	6	3/6	APS Eerik (EST)	P1 P2 P3 6 0 0	6	0/0	BLR	P1 P2 P3 0 0 0
7	4/7	BOUKIS Ilias (GRE)	P1 P2 P3 7 0 0	7	0/0	BOUKIS Ilias (GRE)	P1 P2 P3 0 0 0	7	3/8	KAZ	P1 P2 P3 8 0 0
8	4/7	JANIKOWSKI Damian (POL)	P1 P2 P3 7 0 0	8	5/5	JANIKOWSKI Damian (POL)	P1 P2 P3 5 0 0	8	1/5	CHN	P1 P2 P3 5 0 0
9	4/7	BRAZON BRAVO A. (VEN)	P1 P2 P3 7 0 0	9	0/0	BRAZON BRAVO A. (VEN)	P1 P2 P3 0 0 0	9	5/4	UZB	P1 P2 P3 4 0 0
10	4/7	NEMATPOUR T. (IRI)	P1 P2 P3 7 0 0	10	4/8	NEMATPOUR T. (IRI)	P1 P2 P3 8 0 0	10	0/0	HUN	P1 P2 P3 0 0 0
11	4/7	ADOMAITIS Laimutis (LTU)	P1 P2 P3 7 0 0	11	1/3	ADOMAITIS Laimutis (LTU)	P1 P2 P3 3 0 0	11	0/0	MEX	P1 P2 P3 0 0 0
12	4/7	HAMZATAU Javid (BLR)	P1 P2 P3 7 0 0	12	3/4	HAMZATAU Javid (BLR)	P1 P2 P3 4 0 0	12	3/3	GEO	P1 P2 P3 3 0 0
13	4/7	TURSYNOV Nursultan (KAZ)	P1 P2 P3 7 0 0	13	3/5	TURSYNOV Nursultan (KAZ)	P1 P2 P3 5 0 0	13	4/7	HUN	P1 P2 P3 7 0 0
14	4/7	OMAROV Artur (CZE)	P1 P2 P3 7 0 0	14	1/3	OMAROV Artur (CZE)	P1 P2 P3 3 0 0	14	0/0	USA	P1 P2 P3 0 0 0
15	4/7	CEBI Selcuk (TUR)	P1 P2 P3 7 0 0	15	1/2	CEBI Selcuk (TUR)	P1 P2 P3 2 0 0	15	3/4	AZE	P1 P2 P3 4 0 0
16	4/7	PENG Fei (CHN)	P1 P2 P3 7 0 0	16	3/4	PENG Fei (CHN)	P1 P2 P3 4 0 0	16	1/1	ESP	P1 P2 P3 1 0 0
17	4/7	ASSAKALOV Rustam (UZB)	P1 P2 P3 7 0 0	17	5/4	ASSAKALOV Rustam (UZB)	P1 P2 P3 4 0 0	17	0/0	HON	P1 P2 P3 0 0 0
18	4/7	MARINOV H. (BUL)	P1 P2 P3 7 0 0	18	0/0	MARINOV H. (BUL)	P1 P2 P3 0 0 0	18	4/7	FIN	P1 P2 P3 7 0 0
19	4/7	TSIREKIDZE Giorgi (GEO)	P1 P2 P3 7 0 0	19	3/1	TSIREKIDZE Giorgi (GEO)	P1 P2 P3 1 0 0	19	3/3	GEO	P1 P2 P3 3 0 0
20	4/7	RACHYBA Vasyi (UKR)	P1 P2 P3 7 0 0	20	1/1	RACHYBA Vasyi (UKR)	P1 P2 P3 1 0 0	20	0/0	SWE	P1 P2 P3 0 0 0
21	4/7	LORINCZ Viktor (HUN)	P1 P2 P3 7 0 0	21	4/7	LORINCZ Viktor (HUN)	P1 P2 P3 7 0 0	21	0/0	CRO	P1 P2 P3 0 0 0
22	4/7	SALVADOR MEJIA H. (MEX)	P1 P2 P3 7 0 0	22	0/0	SALVADOR MEJIA H. (MEX)	P1 P2 P3 0 0 0	22	0/0	USA	P1 P2 P3 0 0 0
23	4/7	TAHMASEBI S. (AZE)	P1 P2 P3 7 0 0	23	3/4	TAHMASEBI S. (AZE)	P1 P2 P3 4 0 0	23	3/5	AZE	P1 P2 P3 5 0 0
24	4/7	PONOMARTSCHUK E. (GER)	P1 P2 P3 7 0 0	24	0/0	PONOMARTSCHUK E. (GER)	P1 P2 P3 0 0 0	24	0/0	USA	P1 P2 P3 0 0 0
25	4/7	HOLM Jordan Robert (USA)	P1 P2 P3 7 0 0	25	3/4	HOLM Jordan Robert (USA)	P1 P2 P3 4 0 0	25	0/0	USA	P1 P2 P3 0 0 0
26	4/7	GARCIA PEREZ P. (ESP)	P1 P2 P3 7 0 0	26	1/1	GARCIA PEREZ P. (ESP)	P1 P2 P3 1 0 0	26	4/8	FIN	P1 P2 P3 8 0 0
27	4/7	MARTINEZ ALVAREZ O. (HON)	P1 P2 P3 7 0 0	27	0/0	MARTINEZ ALVAREZ O. (HON)	P1 P2 P3 0 0 0	27	0/0	SWE	P1 P2 P3 0 0 0
28	4/7	HIETANIEMI R. (FIN)	P1 P2 P3 7 0 0	28	4/7	HIETANIEMI R. (FIN)	P1 P2 P3 7 0 0	28	4/8	FIN	P1 P2 P3 8 0 0
29	4/7	ZAHITI Fisnik (SWE)	P1 P2 P3 7 0 0	29	3/1	ZAHITI Fisnik (SWE)	P1 P2 P3 1 0 0	29	0/0	SWE	P1 P2 P3 0 0 0
30	3/3	OKA Taichi (JPN)	P1 P2 P3 3 0 0	30	0/0	OKA Taichi (JPN)	P1 P2 P3 0 0 0	30	0/0	SWE	P1 P2 P3 0 0 0
31	0/0	KUHAR Jure (SLO)	P1 P2 P3 0 0 0	31	0/0	KUHAR Jure (SLO)	P1 P2 P3 0 0 0	31	0/0	SWE	P1 P2 P3 0 0 0
32	4/7	ZUGAJ Nenad (CRO)	P1 P2 P3 7 0 0	32	5/3	ZUGAJ Nenad (CRO)	P1 P2 P3 3 0 0	32	5/6	CRO	P1 P2 P3 6 0 0
33	0/0	WAGNER Michael (AUT)	P1 P2 P3 0 0 0	33	0/0	WAGNER Michael (AUT)	P1 P2 P3 0 0 0	33	0/0	SWE	P1 P2 P3 0 0 0
34	0/0	PIQUET HERRERA G. (CUB)	P1 P2 P3 0 0 0	34	0/0	PIQUET HERRERA G. (CUB)	P1 P2 P3 0 0 0	34	0/0	SWE	P1 P2 P3 0 0 0
35	4/7	MISHIN Aleksey (RUS)	P1 P2 P3 7 0 0	35	0/0	MISHIN Aleksey (RUS)	P1 P2 P3 0 0 0	35	0/0	SWE	P1 P2 P3 0 0 0

**Classement****Sitetalk Wrestling World Championships**

STYLE : GR 84 kg

**1 - Or / Gold**

NEMATPOUR Taleb Nariman

2 - Argent / Silver

TAHMASEBI Saman Ahman

3 - Bronze

HAMZATAU Javid

LORINCZ Viktor

Classement	Nom - Name	Pays - Country
1	NEMATPOUR T.	IRI
2	TAHMASEBI S.	AZE
3	HAMZATAU Javid	BLR
3	LORINCZ Viktor	HUN
5	JANIKOWSKI Damian	POL
5	HIETANIEMI R.	FIN
7	ZUGAJ Nenad	CRO
8	MANUKYAN Maksim	ARM
9	ASSAKALOV Rustam	UZB
10	TURSYNOV Nursultan	KAZ
11	TSIREKIDZE Giorgi	GEO
12	MISHIN Aleksey	RUS
13	PENG Fei	CHN
14	APS Eerik	EST
15	HOLM Jordan Robert	USA
16	OKA Taichi	JPN
17	PIRVAN D.	ROU
18	ZAHITI Fisnik	SWE
19	ADOMAITIS Laimutis	LTU
20	OMAROV Artur	CZE
21	CEBI Selcuk	TUR
22	RACHYBA Vasyl	UKR
23	GARCIA PEREZ P.	ESP
24	BEISHEBEKOV Azat	KGZ
25	KUHAR Jure	SLO
26	MARINOV H.	BUL
27	BOUKIS Ilias	GRE
28	HARPREET Singh	IND
29	PIQUET HERRERA G.	CUB
29	SALVADOR MEJIA H.	MEX



Classement

Sitetalk Wrestling World Championships

STYLE : GR 84 kg



Classement	Nom - Name	Pays - Country
29	PONOMARTSCHUK Eugen	GER
29	MARTINEZ ALVAREZ O.	HON
29	WAGNER Michael	AUT
34	ABD ELSALAM SHIBL T.	EGY
35	BRAZON BRAVO A.	VEN



Feuille de compétition / Competition Sheet

Sitetalk Wrestling World Championships



STYLE : GR 96 kg

QUALIFICATION				1/16 Finale				1/8 FINALE			
	P1	P2	P3		P1	P2	P3		P1	P2	P3
1	0	0	0	LUGO CABRERA Y. (CUB)	0	0	0	1	0	0	0
2	0	0	0	KISS Balazs (HUN)	0	0	0	2	4	6	HUN
3	0	0	0	ABDULOEV K. (TJK)	0	0	0	3	1	7	ABDULOEV K. (TJK)
4	0	0	0	LENGYEL David (SVK)	0	0	0	4	4	14	LENGYEL David (SVK)
5	0	0	0	MEJIA CASTILLO K. (HON)	0	0	0	5	1	2	MEJIA CASTILLO K. (HON)
6	0	0	0	AVANESYAN Robert (ISR)	0	0	0	6	4	7	AVANESYAN Robert (ISR)
7	0	0	0	WILLIAMS C. (USA)	0	0	0	7	0	0	WILLIAMS C. (USA)
8	0	0	0	ILDEM Cenk (TUR)	0	0	0	8	5	3	ILDEM Cenk (TUR)
9	0	0	0	GRZYBICKI R. (POL)	0	0	0	9	1	2	GRZYBICKI R. (POL)
10	0	0	0	METODIEV V. (BUL)	0	0	0	10	3	8	METODIEV V. (BUL)
11	0	0	0	ALEKSANYAN Artur (ARM)	0	0	0	11	3	3	ALEKSANYAN Artur (ARM)
12	0	0	0	ALIYARIFEIZABADI M. (IRI)	0	0	0	12	1	1	ALIYARIFEIZABADI M. (IRI)
13	0	0	0	CAZAC Marin (MDA)	0	0	0	13	3	3	CAZAC Marin (MDA)
14	0	0	0	HARDEEP Singh (IND)	0	0	0	14	1	1	HARDEEP Singh (IND)
15	0	0	0	ISKAKOV Yerulan (KAZ)	0	0	0	15	5	4	ISKAKOV Yerulan (KAZ)
16	0	0	0	HASSLER O. (GER)	0	0	0	16	0	4	HASSLER O. (GER)
17	0	0	0	FRANKOVIC Dejan (SRB)	0	0	0	17	1	1	FRANKOVIC Dejan (SRB)
18	0	0	0	HRABOVIK A. (BLR)	0	0	0	18	4	8	HRABOVIK A. (BLR)
19	0	0	0	ALEXUC-CIURARIU A. (ROU)	0	0	0	19	3	3	ALEXUC-CIURARIU A. (ROU)
20	0	0	0	ABUTABEEKH Y. (JOR)	0	0	0	20	0	0	ABUTABEEKH Y. (JOR)
21	0	0	0	HAMLET NIELSEN M. (NOR)	0	0	0	21	3	2	HAMLET NIELSEN M. (NOR)
22	0	0	0	SCHON C. (SWE)	0	0	0	22	0	0	SCHON C. (SWE)
23	0	0	0	GADABADZE Shalva (AZE)	0	0	0	23	3	5	GADABADZE Shalva (AZE)
24	0	0	0	VALA David (CZE)	0	0	0	24	0	0	VALA David (CZE)
25	0	0	0	CARABALLO CABRERA E. (VEN)	0	0	0	25	0	3	CARABALLO CABRERA E. (VEN)
26	0	0	0	LIM Jiyoung (KOR)	0	0	0	26	5	9	LIM Jiyoung (KOR)
27	0	0	0	FATTOEV Sukhrob (UZB)	0	0	0	27	0	0	FATTOEV Sukhrob (UZB)
28	4	7	0	SAIKAWA Norikatsu (JPN)	0	0	0	28	4	8	SAIKAWA Norikatsu (JPN)
29	0	0	0	XIAO Di (CHN)	0	0	0	29	0	0	XIAO Di (CHN)
30	3	3	0	MELNIKOV Nikita (RUS)	0	0	0	30	4	7	MELNIKOV Nikita (RUS)
31	0	0	0	TIMONCINI Daigoro (ITA)	0	0	0	31	0	0	TIMONCINI Daigoro (ITA)
32	4	7	0	NOUMONVI MÂ@lonin (FRA)	0	0	0	32	0	0	NOUMONVI MÂ@lonin (FRA)
33	0	0	0	VOURDANOS K. (GRE)	0	0	0	33	0	0	VOURDANOS K. (GRE)
34	5	5	0	IMERLISHVILI Vasil (GEO)	0	0	0	34	1	1	IMERLISHVILI Vasil (GEO)
35	0	0	0	ABBASI DAZMIRI M. (NED)	0	0	0	35	0	0	ABBASI DAZMIRI M. (NED)
36	0	0	0	TIMCHENKO Dimitriy (UKR)	0	0	0	36	0	0	TIMCHENKO Dimitriy (UKR)
37	3	2	0	KALLIO Timo Antero (FIN)	0	0	0	37	4	2	KALLIO Timo Antero (FIN)



Feuille de compétition / Competition Sheet

Sitetalk Wrestling World Championships

STYLE : GR 96 kg



Classement

Cl	Pays	Nom
1	RUS	MELNIKOV Nikita
2	ARM	ALEKSANYAN Artur
3	HUN	KISS Balazs
3	AZE	GADABADZE Shalva
5	IRI	ALIYARIFEIZABADI Mahdi Abbas
5	JPN	SAIKAWA Norikatsu
7	KAZ	ISKAKOV Yerulan
8	FIN	KALLIO Timo Antero
9	FRA	NOUMONVI MÃ©lonin
10	TUR	ILDEM Cenk
11	BLR	HRABOVIK Aliaksandr
12	KOR	LIM Jiyoung
13	GEO	IMERLISHVILI Vasil
14	SVK	LENGYEL David
15	ISR	AVANESYAN Robert
16	BUL	METODIEV Vladislav Emilov
17	MDA	CAZAC Marin
18	ROU	ALEXUC-CIURARIU Alin
19	NOR	HAMLET NIELSEN Marius
20	TJK	ABDULOEVI Khabibullo

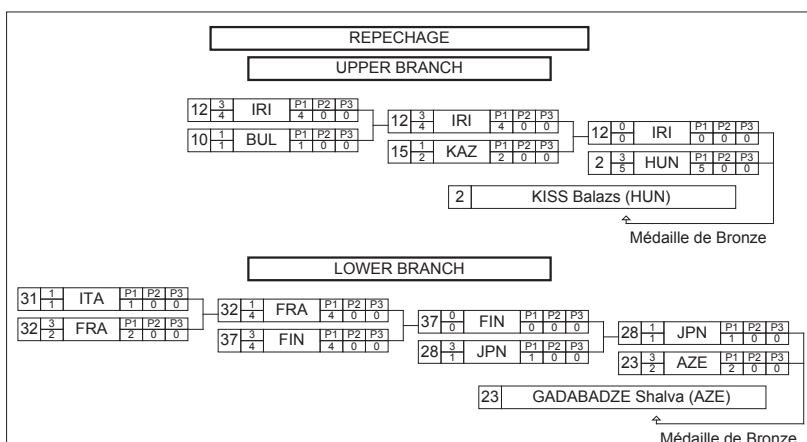

**Classement****Sitetalk Wrestling World Championships**

STYLE : GR 96 kg

**1 - Or / Gold**

MELNIKOV Nikita

2 - Argent / Silver

ALEKSANYAN Artur

3 - Bronze

KISS Balazs

GADABADZE Shalva

Classement	Nom - Name	Pays - Country
1	MELNIKOV Nikita	RUS
2	ALEKSANYAN Artur	ARM
3	KISS Balazs	HUN
3	GADABADZE Shalva	AZE
5	ALIYARIFEIZABADI M.	IRI
5	SAIKAWA Norikatsu	JPN
7	ISKAKOV Yerulan	KAZ
8	KALLIO Timo Antero	FIN
9	NOUMONVI MÃ©lonin	FRA
10	ILDEM Cenk	TUR
11	HRABOVIK Aliaksandr	BLR
12	LIM Jiyoung	KOR
13	IMERLISHVILI Vasil	GEO
14	LENGYEL David	SVK
15	AVANESYAN Robert	ISR
16	METODIEV V.	BUL
17	CAZAC Marin	MDA
18	ALEXUC-CIURARIU A.	ROU
19	HAMLET NIELSEN M.	NOR
20	ABDULOEV Khabibullo	TJK
21	MEJIA CASTILLO K.	HON
22	GRZYBICKI R.	POL
23	HARDEEP Singh	IND
24	TIMONCINI Daigoro	ITA
25	FRANKOVIC Dejan	SRB
26	HASSLER O.	GER
27	CARABALLO CABRERA E.	VEN
28	TIMCHENKO Dimitriy	UKR
28	SCHON C.	SWE
30	ABUTABEEKH Y.	JOR



Classement

Sitetalk Wrestling World Championships

STYLE : GR 96 kg



<i>Classement</i>	<i>Nom - Name</i>	<i>Pays - Country</i>
30	WILLIAMS C.	USA
32	LUGO CABRERA Y.	CUB
33	ABBASI DAZMIRI M.	NED
33	VALA David	CZE
35	VOURDANOS K.	GRE
35	XIAO Di	CHN
37	FATTOEV Sukhrob	UZB



STATISTICS

SENIOR WORLD CHAMPIONSHIP - 2013.



WORLD WRESTLING SENIOR CHAMPIONSHIP

2013.

Budapest (HUN)

APPENDIX

1. **NUMBERS MEDALS WCH - GR**
2. **NUMBERS MEDALS WCH - FW**
3. **NUMBERS MEDALS WCH - FS**
4. **NUMBERS MEDALS TOTAL WCH (GR, FW, FS)**
5. **NUMBERS POINTS TOTAL WCH (GR, FW, FS)**
6. **NUMBER WRESTLERS TOTAL WCH (GR, FW, FS)**
7. **PICTURE WINERS GR WCH**
8. **PICTURE WINERS FW GR**
9. **PICTURE WINERS FS WCH**



STATISTICS

SENIOR WORLD CHAMPIONSHIP - 2013.



NUMBER MEDALS - GR					
Rang	Equipe	GOLD	SILVER	BRONZE	TOTAL
1	KOR	2	1	1	4
2	IRI	2			2
3	RUS	1	3		4
4-5	BUL	1			1
4-5	PRK	1			1
6	ARM		1	2	3
7	AZE		1	1	2
8	EST		1		1
9	HUN			3	3
10	TUR			2	2
11-15	KAZ			1	1
11-15	GER			1	1
11-15	UZB			1	1
11-15	BLR			1	1
11-15	IND			1	1
Total =		7	7	14	28

Note - Olympics ranking (gold, silver, bronze)

**STATISTICS****SENIOR WORLD CHAMPIONSHIP - 2013.****NUMBER MEDALS - FW**

Rang	Equipe	GOLD	SILVER	BRONZE	TOTAL
1	JPN	3		1	4
2	CHN	2		1	3
3	HUN	1		1	2
4	UKR	1			1
5	MGL		2	3	5
6-7	RUS		1	1	2
6-7	CAN		1	1	2
8-10	SWE		1		1
8-10	VEN		1		1
8-10	BUL		1		1
11	USA			3	3
12-14	KAZ			1	1
12-14	PRK			1	1
12-14	AZE			1	1
Total =		7	7	14	28

Note - Olympics ranking (gold, silver, bronze)



STATISTICS

SENIOR WORLD CHAMPIONSHIP - 2013.



NUMBER MEDALS - FS

Rang	Equipe	GOLD	SILVER	BRONZE	TOTAL
1	IRI	2	1	2	5
2	RUS	2		3	5
3	UKR	1	1	1	3
4-5	USA	1			1
4-5	ARM	1			1
6	CUB		2		2
7	IND		1	1	2
8-9	BUL		1		1
8-9	AZE		1		1
10	TUR			2	2
11-15	GEO			1	1
11-15	MGL			1	1
11-15	BLR			1	1
11-15	HUN			1	1
11-15	JPN			1	1
Total =		7	7	14	28

Note - Olympics ranking (gold, silver, bronze)



STATISTICS

SENIOR WORLD CHAMPIONSHIP - 2013.



NUMBER MEDALS - TOTAL
GR - FS - FW

Rang	Equipe	GR			FW			FS			TOTAL			Total
		G	S	B	G	S	B	G	S	B	G	S	B	
1	IRI	2						2	1	2	4	1	2	7
2	RUS	1	3			1	1	2		3	3	4	4	11
3	JPN				3		1			1	3		2	5
4-5	KOR	2	1	1							2	1	1	4
4-5	UKR				1			1	1	1	2	1	1	4
6	CHN				2		1				2		1	3
7	AZE		1	1			1	1	1		1	2	2	5
8	BUL	1				1			1		1	2		3
9	HUN			3	1		1			1	1		5	6
10	USA						3	1			1		3	4
11	PRK	1					1				1		1	2
12	MGL					2	3			1		2	4	6
13-14	IND			1					1	1		1	2	3
13-14	ARM		1	2								1	2	3
15	CAN					1	1					1	1	2
16	CUB								2			2		2
17-19	EST		1									1		1
17-19	SWE					1						1		1
17-19	VEN					1						1		1
20	TUR			2						2			4	4
21-22	KAZ			1			1						2	2
21-22	BLR			1						1			2	2
23-25	GER			1									1	1
23-25	UZB			1									1	1
23-25	GEO									1			1	1
TOTAL =		7	7	14	7	7	14	7	7	14	21	21	42	84

Note - Olympics ranking (gold, silver, bronze)

**STATISTICS****SENIOR WORLD CHAMPIONSHIP - 2013.****NUMBER POINTS - TOTAL**
GR - FW - FS

Rang	Equipe	GR	FW	FS	TOTAL
1	RUS	43	24	44	111
2-3	IRI	29		46	75
2-3	USA	13	37	25	75
4	JPN	10	48	9	67
5	MGL		47	19	66
6	UKR	4	29	27	60
7	HUN	31	18	10	59
8	AZE	27	10	15	52
9	ARM	28		18	46
10-11	CHN	3	34	6	43
10-11	TUR	19	6	18	43
12	KAZ	21	12	6	39
13	KOR	37	0	0	37
14	BUL	10	15	9	34
15	IND	8	1	23	32
16-17	BLR	8	6	15	29
16-17	GEO	0		29	29
18	PRK	10	11	6	27
19	POL	12	10	4	26
20	GER	11	6	8	25
21	CAN		21	3	24
22-23	CUB	0	0	19	19
22-23	KGZ	6	4	9	19
24	UZB	10	0	8	18

**STATISTICS****SENIOR WORLD CHAMPIONSHIP - 2013.**

Rang	Equipe	GR	FW	FS	TOTAL
25	FRA	3	9	4	16
26-27	SWE	6	9		15
26-27	FIN	15		0	15
28	EST	9	1	0	10
29-31	VEN	0	9	0	9
29-31	MDA	1	6	2	9
29-31	COL	0	9	0	9
32	SRB	8		0	8
33	ESP	0	1	6	7
34-36	DEN	6			6
34-36	GRE	4	2	0	6
34-36	ROU	0	0	6	6
37-39	CRO	4			4
37-39	LAT	0	4	0	4
37-39	PUR			4	4
40-43	TUN	2	1		3
40-43	BRA	0	3	0	3
40-43	ITA	0	3		3
40-43	SEN		3	0	3
44-45	DOM	1		0	1
44-45	ALB			1	1
46-87	ALG	0			0
46-87	AUT	0	0	0	0
46-87	CZE	0	0	0	0
46-87	EGY	0	0	0	0
46-87	GUM	0			0
46-87	HON	0		0	0

**STATISTICS****SENIOR WORLD CHAMPIONSHIP - 2013.**

Rang	Equipe	GR	FW	FS	TOTAL
46-87	IRQ	0		0	0
46-87	ISR	0	0	0	0
46-87	JOR	0			0
46-87	LTU	0		0	0
46-87	MAR	0			0
46-87	MEX	0	0	0	0
46-87	MNE	0			0
46-87	NCA	0			0
46-87	NDA	0			0
46-87	NOR	0			0
46-87	NZL	0		0	0
46-87	PAN	0			0
46-87	POR	0			0
46-87	SLO	0			0
46-87	SUI	0		0	0
46-87	SVK	0		0	0
46-87	TJK	0		0	0
46-87	TPE	0	0		0
46-87	URU	0			0
46-87	VIE	0	0		0
46-87	ARG		0	0	0
46-87	CMR		0		0
46-87	MZL		0		0
46-87	PER		0	0	0
46-87	RSA		0	0	0
46-87	AUS			0	0
46-87	CHA			0	0



STATISTICS

SENIOR WORLD CHAMPIONSHIP - 2013.



Rang	Equipe	GR	FW	FS	TOTAL
46-87	ESA			0	0
46-87	GBS			0	0
46-87	GUA			0	0
46-87	MAD			0	0
46-87	MKD			0	0
46-87	MRI			0	0
46-87	PLW			0	0
46-87	QAT			0	0
46-87	SRI			0	0
Total =		399	399	399	1197

**STATISTICS****SENIOR WORLD CHAMPIONSHIP - 2013.****NUMBER WRESTLERS - TOTAL****GR - FS - FW**

Rang	Equipe	GR	FW	FS	TOTAL
1-9	BLR	7	7	7	21
1-9	CHN	7	7	7	21
1-9	HUN	7	7	7	21
1-9	IND	7	7	7	21
1-9	JPN	7	7	7	21
1-9	KAZ	7	7	7	21
1-9	RUS	7	7	7	21
1-9	UKR	7	7	7	21
1-9	USA	7	7	7	21
10-11	BUL	7	6	7	20
10-11	TUR	7	6	7	20
12-13	AZE	7	4	7	18
12-13	POL	7	6	5	18
14-16	GER	6	5	6	17
14-16	KOR	6	4	7	17
14-16	VEN	6	5	6	17
17	ROU	5	4	6	15
18-22	CAN		7	7	14
18-22	GEO	7		7	14
18-22	IRI	7		7	14
18-22	MDA	5	2	7	14
18-22	MGL		7	7	14
23-24	ARM	7		6	13
23-24	GRE	6	2	5	13
25-26	KGZ	5	1	6	12
25-26	UZB	5	1	6	12
27	CUB	4	3	4	11
28	SWE	7	3		10
29-31	BRA	2	4	3	9
29-31	COL	2	5	2	9

**STATISTICS****SENIOR WORLD CHAMPIONSHIP - 2013.**

Rang	Equipe	GR	FW	FS	TOTAL
29-31	VIE	1	5	3	9
32-33	MEX	3	3	2	8
32-33	SVK	4		4	8
34-38	AUT	3	3	1	7
34-38	CZE	5	1	1	7
34-38	EGY	2	2	3	7
34-38	FRA	2	3	2	7
34-38	PRK	1	3	3	7
39-42	DOM	3		3	6
39-42	ESP	2	2	2	6
39-42	EST	3	1	2	6
39-42	LTU	4	0	2	6
43-47	CRO	5			5
43-47	FIN	4		1	5
43-47	LAT	1	2	2	5
43-47	SRB	4		1	5
43-47	SRI			5	5
48-55	ISR	1	1	2	4
48-55	ITA	1	3		4
48-55	HON	3		1	4
48-55	NOR	4			4
48-55	NZL	1	1	2	4
48-55	PUR			4	4
48-55	RSA		2	2	4
48-55	TJK	2		2	4
56-60	ARG		2	1	3
56-60	SEN		2	1	3
56-60	SUI	1		2	3
56-60	TPE	1	2		3
56-60	TUN	1	2		3
61-69	ALB			2	2
61-69	ALG	2			2
61-69	CMR		2		2



STATISTICS

SENIOR WORLD CHAMPIONSHIP - 2013.



Rang	Equipe	GR	FW	FS	TOTAL
61-69	DEN	2			2
61-69	IRQ	1		1	2
61-69	MAD			2	2
61-69	MKD			2	2
61-69	PAN	2			2
61-69	PER		1	1	2
70-87	AUS			1	1
70-87	GUA	1			1
70-87	CHA			1	1
70-87	ESA			1	1
70-87	GBR		1		1
70-87	GBS			1	1
70-87	JOR	1			1
70-87	MAR	1			1
70-87	MNE	1			1
70-87	MRI			1	1
70-87	NCA	1			1
70-87	NED	1			1
70-87	PLW			1	1
70-87	POR	1			1
70-87	QAT			1	1
70-87	SLO	1			1
70-87	URU	1			1
70-87	GUA			1	1
Total WRESTLERS =		249	182	251	682
Total NATION STYLE=		66	48	67	
TOTAL NATION ALL STYLE		87			



STATISTICS
SENIOR WORLD CHAMPIONSHIP - 2013.



PHOTOS WINNERS / GR – WCH SENIOR – 2013.



GR – 55 kg



GR – 60 kg



GR – 66 kg



STATISTICS
SENIOR WORLD CHAMPIONSHIP - 2013.



PHOTOS WINNERS / GR – WCH SENIOR – 2013.



GR – 74 kg



GR – 84



GR – 96 KG



STATISTICS
SENIOR WORLD CHAMPIONSHIP - 2013.



PHOTOS WINNERS / GR – WCH SENIOR - 2013.



GR – 120 kg



BEST PICTURE GR WCH

Foto sources – FILA FOTO



STATISTICS
SENIOR WORLD CHAMPIONSHIP - 2013.



PHOTOS WINNERS / FW – WCH SENIOR – 2013.



FW –48 kg



FW –51 kg



FW –55 kg



STATISTICS
SENIOR WORLD CHAMPIONSHIP - 2013.



PHOTOS WINNERS / FW – WCH SENIOR – 2013.



FW –55 kg



FW –63 kg



FW –67 kg



STATISTICS

SENIOR WORLD CHAMPIONSHIP - 2013.



PHOTOS WINNERS / FW – WCH SENIOR 2013.



FW –72 kg



BEST PICTURE FWWCH



STATISTICS
SENIOR WORLD CHAMPIONSHIP - 2013.



PHOTOS WINNERS / FS – WCH SENIOR 2013.



FS –55 kg



FS –60 kg



FS –66 kg



STATISTICS
SENIOR WORLD CHAMPIONSHIP - 2013.



PHOTOS WINNERS / FS – WCH SENIOR 2013.



FS –74 kg

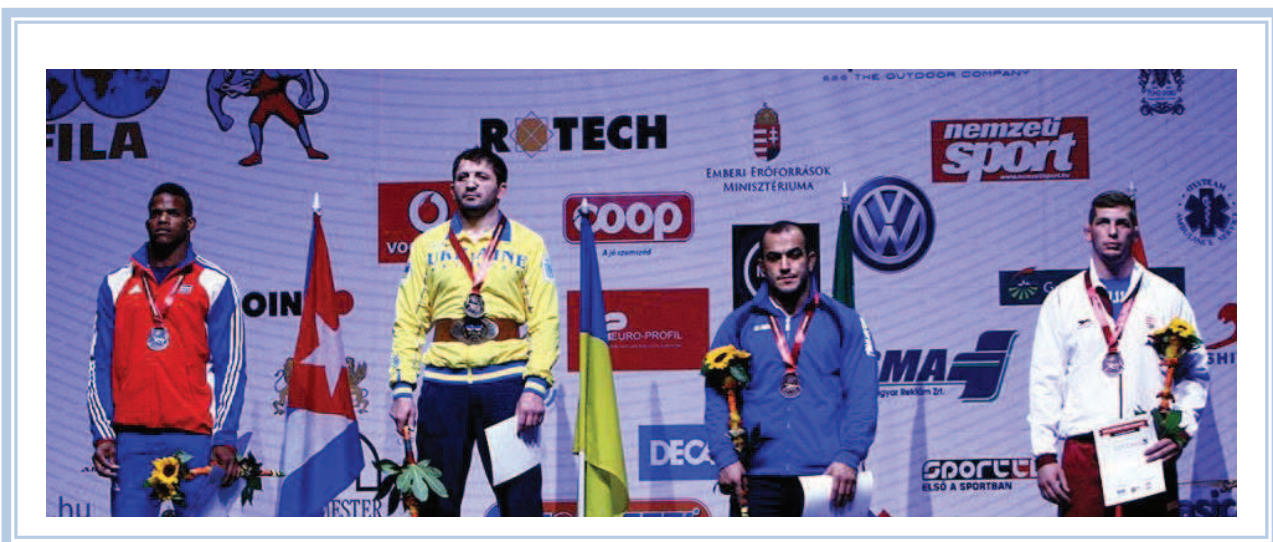

FS –84 kg



FS –96 kg



STATISTICS
SENIOR WORLD CHAMPIONSHIP - 2013.



PHOTOS WINNERS / FS – WCH SENIOR 2013.



FS –120 kg

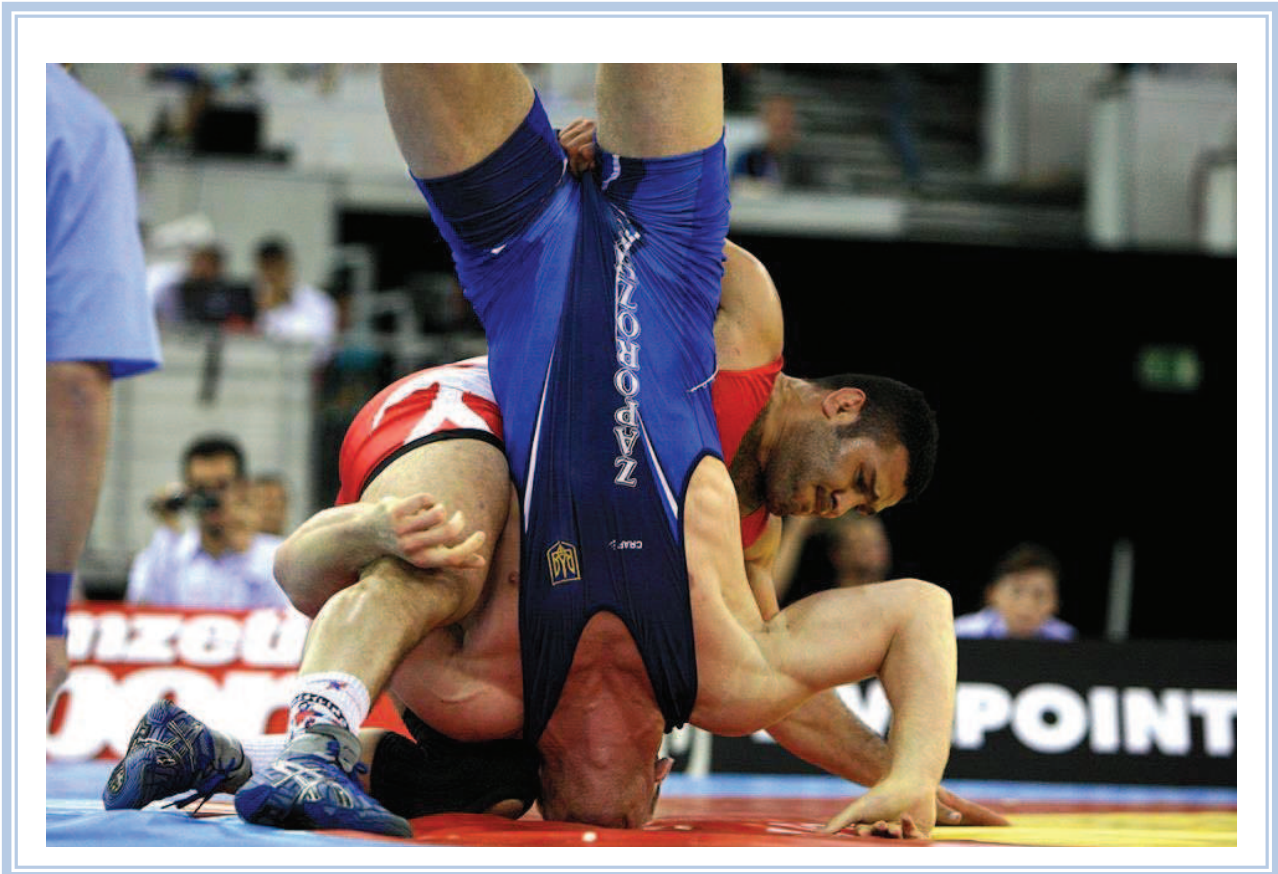

BEST PICTURE FS WCH

Foto sources – FILA FOTO