

SENIOR EUROPEAN CHAMPIONSHIP - BELGRADE 2012



BELGRADE (SRB)

2012 - 03 - 06 - 2012 - 03- 12

Résultats - Results

Free style





Raphael Marineti

President FILA

TzenoTzenov

President CEL

Kim Ik-Jong (UZB)

Techical delegate

Ruziev Akhro (KOR)

Tehical delegate

IantchoKostandinov (BUL)

FILA Instructor

AyikAhmet (TUR)

Vice-President FILA

Stan Dziedic (USA)

Vice-President FILA

DrPelliconeMatteo (ITA)

Vice-President FILA

Michel Dusson (FRA)

General Secretary FILA

NamigAliyev (AZE)

FILA Bureau member

TheodorosHamakos (GRE)

FILA Bureau member

CsabaHegedus (HUN)

FILA Bureau member

NenadLalovic (SRB)

FILA Bureau member

Mikhail Mamiashvili (RUS)

FILA Bureau member

Rodica Maia Yaksi (TUR)

FILA Bureau member

ZeljkoTrajkovic

President Wrestling Federation of Serbia

Rajko Baltic

Director ECH – Belgrad 2012.



Liste des équipes / Teams List

Senior European Championship 2012

STYLE FS



Equipes - Teams

	ALBANIE	ALB
	ALLEMAGNE	GER
	ARMENIE	ARM
	AUTRICHE	AUT
	AZERBAIDJAN	AZE
	BELARUS	BLR
	BULGARIE	BUL
	CHYPRE	CYP
	ESPAGNE	ESP
	ESTONIE	EST
	FINLANDE	FIN
	FRANCE	FRA
	GEORGIE	GEO
	GRANDE BRETAGNE	GBR
	GRECE	GRE
	HONGRIE	HUN
	IRLANDE	IRL
	ISRAEL	ISR
	ITALIE	ITA
	LETTONIE	LAT
	LITUANIE	LTU
	MACEDOINE ANC. R. YUG	MKD
	MOLDAVIE	MDA
	MONACO	MON
	POLOGNE	POL
	ROUMANIE	ROU
	RUSSIE	RUS
	SERBIA	SRB
	SLOVAQUIE	SVK
	SUISSE	SUI
	TCHEQUE REP.	CZE
	TURQUIE	TUR
	UKRAINE	UKR

Nombre d'équipes - Number of Teams

33

**Nombre d'engagés par équipe / Number of Entries By Team****Senior European Championship 2012****STYLE FS**

Equipe - Teams	120 KG	55 KG	60 KG	66 KG	74 KG	84 KG	96 KG	TOTAL
ALB	1	1				1		3
ARM	1	1	1	1	1	1	1	7
AUT			1	1	1			3
AZE	1	1	1	1	1	1	1	7
BLR	1	1	1	1	1	1	1	7
BUL	1	1	1	1	1	1	1	7
CYP				1			1	2
CZE					1			1
ESP	1		1		1	1		4
EST					1			1
FIN					1			1
FRA		1			1	1		3
GBR				1	1	1	1	4
GEO	1	1	1	1	1	1	1	7
GER	1	1	1	1	1	1	1	7
GRE	1		1	1	1	1	1	6
HUN	1	1	1	1	1	1	1	7
IRL						1		1
ISR						1		1
ITA				1	1	1		3
LAT	1					1	1	3
LTU		1	1			1		3
MDA	1	1	1	1	1	1	1	7
MON		1						1
MKD	1		1	1	1	1	1	6
POL	1	1	1	1	1	1	1	7
ROU	1	1	1	1	1	1	1	7
RUS	1	1	1	1	1	1	1	7
SRB	1	1	1	1	1	1	1	7
SUI		1			1	1		3
SVK	1		1	1	1	1	1	6
TUR	1	1	1	1	1	1	1	7
UKR	1	1	1	1	1	1	1	7
TOTAL	20	19	20	21	26	27	20	153

Nombre de nations - Number of Countries **33**



Feuille de compétition / Competition Sheet

Senior European Championship 2012



STYLE : FS 55 kg

QUALIFICATION			1/8 FINALE			1/4 FINALE			1/2 FINALE			FINALE								
1		KRAUSE Emanuel (GER)				1	1	GER	P1	P2	P3	11	2	0						
2		KOMAR Andrei (BLR)				2	3	BLR	P1	P2	P3	1	7	5						
3		ALIYEV Galib (AZE)				3	0	AZE	P1	P2	P3	0	1	0						
4		JABURYAN Mihran (ARM)				4	5	ARM	P1	P2	P3	1	0	3						
5		VELIKOV R. (BUL)				5	3	BUL	P1	P2	P3	0	1	4						
6		TULBEA Ghenadie (MON)				6	1	MON	P1	P2	P3	1	0	0						
7		OTARSULTANOV D. (RUS)				7	3	RUS	P1	P2	P3	3	5	0						
8		DUKOV Andrei (ROU)				8	1	ROU	P1	P2	P3	1	1	0						
9		BENKOVSKI Adam (POL)				9	3	POL	P1	P2	P3	1	4	3						
10		ISLAMAJ Islam (ALB)				10	1	ALB	P1	P2	P3	3	0	0						
11		CHIRTOACA A. (MDA)				11	3	MDA	P1	P2	P3	7	2	0						
12		WILD Urs (SUI)				12	0	SUI	P1	P2	P3	0	0	0						
13		KHAVALDZHY Igor (UKR)				13	5	UKR	P1	P2	P3	2	3	0						
14	3	MOLNAR Robert (HUN)	P1	P2	P3	14	0	HUN	P1	P2	P3	4	6	0	1	1	0			
	10		4	6	0															
15	0	MARKOVIC Nikola (SRB)	P1	P2	P3	15	0	SRB	P1	P2	P3	0	0	0						
	0		0	0	0															
16	3	GOCHASHVILI B. (GEO)	P1	P2	P3	16	3	GEO	P1	P2	P3	1	6	0	0	1	1			
	7		1	6	0															
17	0	JURCYS Sarunas (LTU)	P1	P2	P3	17	0	LTU	P1	P2	P3	0	0	0						
	0		0	0	0															
18	3	PEKER Ahmet (TUR)	P1	P2	P3	18	1	TUR	P1	P2	P3	2	4	0	3	0	0			
	6		2	4	0															
19	0	ANSARI Chakir (FRA)	P1	P2	P3	19	0	FRA	P1	P2	P3	0	0	0						
	0		0	0	0															

7 OTARSULTANOV D. (RUS)

Classement

Cl	Pays	Nom
1	RUS	OTARSULTANOV D.
2	GEO	GOCHASHVILI B.
3	BUL	VELIKOV R.
3	TUR	PEKER Ahmet
5	ARM	JABURYAN Mihran
5	MDA	CHIRTOACA Alexandru
7	UKR	KHAVALDZHY Igor
8	BLR	KOMAR Andrei
9	HUN	MOLNAR Robert
10	POL	BENKOVSKI Adam
11	ROU	DUKOV Andrei
12	GER	KRAUSE Emanuel
13	ALB	ISLAMAJ Islam
14	MON	TULBEA Ghenadie
15	AZE	ALIYEV Galib
16	FRA	ANSARI Chakir
17	SUI	WILD Urs
18	SRB	MARKOVIC Nikola
19	LTU	JURCYS Sarunas

REPECHAGE											
REPECHAGE FINALISTE 1											
8	1	ROU	P1	P2	P3	5	3	BUL	P1	P2	P3
	1		0	1	0		3		1	2	0
5	3	BUL	P1	P2	P3	4	1	ARM	P1	P2	P3
	4		1	0	3		1		0	1	0
5 VELIKOV R. (BUL)											
Médaille de Bronze											
REPECHAGE FINALISTE 2											
17	0	LTU	P1	P2	P3	18	3	TUR	P1	P2	P3
	0		0	0	0		4		1	3	0
18	4	TUR	P1	P2	P3	13	0	UKR	P1	P2	P3
	10		3	7	0		0		0	0	0
18 PEKER Ahmet (TUR)											
Médaille de Bronze											



Classement

Senior European Championship 2012



STYLE : FS 55 kg

1 - Or / Gold

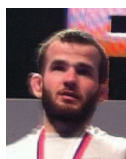

OTARSULTANOV Dzhamal

2 - Argent / Silver

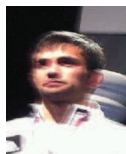

GOCHASHVILI Besarion

3 - Bronze

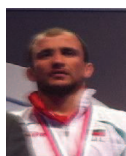

VELIKOV Radoslav Marinov



PEKER Ahmet

Classement	Nom - Name	Pays - Country
1	OTARSULTANOV D.	RUS
2	GOCHASHVILI B.	GEO
3	VELIKOV R.	BUL
3	PEKER Ahmet	TUR
5	JABURYAN Mihran	ARM
5	CHIRTOACA Alexandru	MDA
7	KHAVALDZHY Igor	UKR
8	KOMAR Andrei	BLR
9	MOLNAR Robert	HUN
10	BENKOVSKI Adam	POL
11	DUKOV Andrei	ROU
12	KRAUSE Emanuel	GER
13	ISLAMAJ Islam	ALB
14	TULBEA Ghenadie	MON
15	ALIYEV Galib	AZE
16	ANSARI Chakir	FRA
17	WILD Urs	SUI
18	MARKOVIC Nikola	SRB
19	JURCYS Sarunas	LTU



Feuille de compétition / Competition Sheet

Senior European Championship 2012



STYLE : FS 60 kg

QUALIFICATION		1/8 FINALE		1/4 FINALE		1/2 FINALE		FINALE	
1	KHAIVILOV Yevhenii (UKR)	1	5/4 UKR	1	4/13 UKR	1	0/0 UKR	6	1/6 BUL
2	DESIC Dragan (SRB)	2	0/0 SRB	4	0/0 MKD	6	3/2 BUL	9	3/13 AZE
3	AUSSERLEITNER M. (AUT)	3	1/1 AUT	6	4/14 BUL	9	3/14 AZE	9	3/10 AZE
4	ISMAILI Rufat (MKD)	4	3/3 MKD	8	1/1 GER	11	1/1 GEO	11	1/1 GEO
5	MURTAZALIEV Rasul (RUS)	5	1/3 RUS	11	3/2 GEO	12	0/0 SVK	12	0/0 SVK
6	GUIDEA A. (BUL)	6	3/2 BUL	14	0/0 MDA	16	3/3 BLR	16	3/3 BLR
7	CUMAKOV Vytas (LTU)	7	1/1 LTU	16	3/3 BLR	18	5/5 ROU	18	5/5 ROU
8	SCHLEICHER Tim (GER)	8	3/7 GER	18	3/6 ROU	19	0/0 POL	19	0/0 POL
9	ASGAROV Toghzul (AZE)	9	3/11 AZE	18	1/1 ROU	20	3/4 ARM	20	3/4 ARM
10	AKTAS Munir Recep (TUR)	10	1/1 TUR	19	0/0 POL				
11	ZARKUA Malkhaz (GEO)	11	3/2 GEO						
12	BOLOTNJUK Mykola (SVK)	12	0/0 SVK						
13	MOLNAR Jozsef (HUN)	13	1/4 HUN						
14	NEGRU Pavel (MDA)	14	3/5 MDA						
15	OVSEPIAN Antranik (GRE)	15	0/0 GRE						
16	ANDREYEU U. (BLR)	16	4/14 BLR						
17	CASTILLO SILVEIRA Y. (ESP)	17	0/0 ESP						
18	BUCUR George (ROU)	18	3/5 ROU						
19	BIENKOWSKI K. (POL)	19	0/0 POL						
20	ARAKELIAN Artur (ARM)	20	3/4 ARM						

9 ASGAROV Toghzul (AZE)

Classement

Cl	Pays	Nom
1	AZE	ASGAROV Toghzul
2	BUL	GUIDEA A.
3	RUS	MURTAZALIEV Rasul
3	GEO	ZARKUA Malkhaz
5	UKR	KHAIVILOV Yevhenii
5	ROU	BUCUR George
7	BLR	ANDREYEU Uladzislau
8	GER	SCHLEICHER Tim
9	ARM	ARAKELIAN Artur
10	MDA	NEGRU Pavel
11	MKD	ISMAILI Rufat
12	TUR	AKTAS Munir Recep
13	HUN	MOLNAR Jozsef
14	AUT	AUSSERLEITNER M.
15	LTU	CUMAKOV Vytas
16	SVK	BOLOTNJUK Mykola
17	SRB	DESIC Dragan
17	POL	BIENKOWSKI K.
19	ESP	CASTILLO SILVEIRA Y.
20	GRE	OVSEPIAN Antranik

REPECHAGE

REPECHAGE FINALISTE 1

5	5/0 RUS	5	3/10 RUS
8	0/0 GER	1	0/0 UKR
5 MURTAZALIEV Rasul (RUS)			

Médaille de Bronze

REPECHAGE FINALISTE 2

10	1/1 TUR	11	3/5 GEO
11	3/2 GEO	18	1/1 ROU
11 ZARKUA Malkhaz (GEO)			

Médaille de Bronze



Classement

Senior European Championship 2012

STYLE : FS 60 kg



1 - Or / Gold

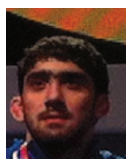

ASGAROV Toghzul

2 - Argent / Silver

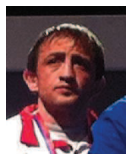

GUIDEA Anatolie Ilarionovitch

3 - Bronze



MURTAZALIEV Rasul



ZARKUA Malkhaz

Classement	Nom - Name	Pays - Country
1	ASGAROV Toghzul	AZE
2	GUIDEA A.	BUL
3	MURTAZALIEV Rasul	RUS
3	ZARKUA Malkhaz	GEO
5	BUCUR George	ROU
5	KHAVILOV Yevhenii	UKR
7	ANDREYEU Uladzislau	BLR
8	SCHLEICHER Tim	GER
9	ARAKELYAN Artur	ARM
10	NEGRU Pavel	MDA
11	ISMAILI Rufat	MKD
12	AKTAS Munir Recep	TUR
13	MOLNAR Jozsef	HUN
14	AUSSERLEITNER M.	AUT
15	CUMAKOV Vytas	LTU
16	BOLOTNJUK Mykola	SVK
17	DESIC Dragan	SRB
17	BIENKOWSKI K.	POL
19	CASTILLO SILVEIRA Y.	ESP
20	OVSEPIAN Antranik	GRE



Feuille de compétition / Competition Sheet

Senior European Championship 2012



STYLE : FS 66 kg

QUALIFICATION		1/8 FINALE		1/4 FINALE		1/2 FINALE		FINALE	
1	BLOK Adam Konrad (POL)	1	0	POL	P1	P2	P3		
			0		0	0	0		
2	GOGAEV Alan (RUS)	2	3	RUS	P1	P2	P3		
			5		2	3	0		
3	GOR Yakup (TUR)	3	3	TUR	P1	P2	P3		
			7		1	6	0		
4	MITROV Dejan (MKD)	4	0	MKD	P1	P2	P3		
			0		0	0	0		
5	MARCHL Georg (AUT)	5	0	AUT	P1	P2	P3		
			0		0	0	0		
6	SAFARYAN Devid (ARM)	6	3	ARM	P1	P2	P3		
			7		3	4	0		
7	AZIZOV Emin (AZE)	7	3	AZE	P1	P2	P3		
			8		3	5	0		
8	MADYARCHYK O. (GBR)	8	0	GBR	P1	P2	P3		
			0		0	0	0		
9	WOLLER Gergely (HUN)	9	3	HUN	P1	P2	P3		
			5		2	3	0		
10	CEABAN Yan (ROU)	10	1	ROU	P1	P2	P3		
			2		2	0	0		
11	BAZAN L. (BUL)	11	5	BUL	P1	P2	P3		
			13		7	6	0		
12	GOTISAN Vladimir (MDA)	13	0	ITA	P1	P2	P3		
			0		0	0	0		
13	CAMPAGNA Raimondo (ITA)	13	5	ITA	P1	P2	P3		
			4		4	0	0		
14	GECIN Mirjan (SRB)	15	3	GEO	P1	P2	P3		
			0		3	1	0		
15	TUSHISHVILI Otar (GEO)	15	3	GEO	P1	P2	P3		
			11		5	6	0		
16	BATYRAU Albert (BLR)	16	1	BLR	P1	P2	P3		
			1		1	0	0		
17	MAMA Stelios (CYP)	19	1	GER	P1	P2	P3		
			0		0	1	0		
18	TRIANAFYLLIDIS A. (GRE)	20	3	UKR	P1	P2	P3		
			1		2	6	0		
19	DAUM M. (GER)	20	3	UKR	P1	P2	P3		
			5		2	6	0		
20	STADNIK Andriy (UKR)	20	1	UKR	P1	P2	P3		
			3		3	0	0		
21	OBZERA Peter (SVK)								

2 GOGAEV Alan (RUS)

Classement

Cl	Pays	Nom
1	RUS	GOGAEV Alan
2	BUL	BAZAN L.
3	ARM	SAFARYAN Devid
3	HUN	WOLLER Gergely
5	TUR	GOR Yakup
5	GEO	TUSHISHVILI Otar
7	UKR	STADNIK Andriy
8	ITA	CAMPAGNA Raimondo
9	AZE	AZIZOV Emin
10	BLR	BATYRAU Albert
11	GER	DAUM M.
12	ROU	CEABAN Yan
13	GRE	TRIANAFYLLIDIS A.
14	SVK	OBZERA Peter
15	MDA	GOTISAN Vladimir
16	CYP	MAMA Stelios
17	AUT	MARCHL Georg
17	POL	BLOK Adam Konrad
17	MKD	MITROV Dejan
20	GBR	MADYARCHYK O.
21	SRB	GECIN Mirjan

REPECHAGE

REPECHAGE FINALISTE 1

1	0	POL	P1	P2	P3		
	0		0	0	0		
3	3	TUR	P1	P2	P3		
	2		1	1	0		
6	3	ARM	P1	P2	P3		
	2		0	1	1		

6 SAFARYAN Devid (ARM)

Médaille de Bronze

REPECHAGE FINALISTE 2

13	1	ITA	P1	P2	P3		
	4		1	3	0		
9	3	HUN	P1	P2	P3		
	6		2	4	0		
15	1	GEO	P1	P2	P3		
	1		0	1	0		

9 WOLLER Gergely (HUN)

Médaille de Bronze



Classement

Senior European Championship 2012

STYLE : FS 66 kg



1 - Or / Gold

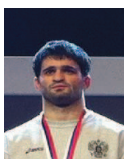

GOGAEV Alan

2 - Argent / Silver

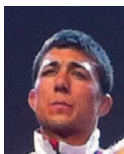

BAZAN Leonid Anatolievich

3 - Bronze

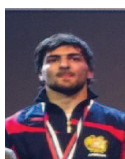

SAFARYAN Devid



WOLLER Gergely

Classement	Nom - Name	Pays - Country
1	GOGAEV Alan	RUS
2	BAZAN L.	BUL
3	SAFARYAN Devid	ARM
3	WOLLER Gergely	HUN
5	TUSHISHVILI Otar	GEO
5	GOR Yakup	TUR
7	STADNIK Andriy	UKR
8	CAMPAGNA Raimondo	ITA
9	AZIZOV Emin	AZE
10	BATYRAU Albert	BLR
11	DAUM M.	GER
12	CEABAN Yan	ROU
13	TRIANAFYLLIDIS A.	GRE
14	OBZERA Peter	SVK
15	GOTISAN Vladimir	MDA
16	MAMA Stelios	CYP
17	MITROV Dejan	MKD
17	BLOK Adam Konrad	POL
17	MARCHL Georg	AUT
20	MADYARCHYK O.	GBR
21	GECIN Mirjan	SRB



Feuille de compétition / Competition Sheet

Senior European Championship 2012



STYLE : FS 74 kg

QUALIFICATION			1/8 FINALE			1/4 FINALE			1/2 FINALE			FINALE				
1	VRENEZI Ljuljzim (MKD)		1	3	MKD	P1	P2	P3	1	0	MKD	P1	P2	P3		
				6		2	4	0		0		0	0	0		
2	CREPAZ Philipp (AUT)		2	0	AUT	P1	P2	P3	4	1	UKR	P1	P2	P3		
				1		0	1	0				1	0	0		
3	AFANASYEU Anton (BLR)		3	0	BLR	P1	P2	P3	4	4	UKR	P1	P2	P3		
				0		0	0	0		12		6	6	0		
4	BILOTSERKIVSKYI O. (UKR)		4	3	UKR	P1	P2	P3	6	3	RUS	P1	P2	P3		
				3		1	2	0		10		6	4	0		
5	MATSALIN Oleg (GRE)		5	0	GRE	P1	P2	P3	9	0	HUN	P1	P2	P3		
				0		0	0	0		7		0	0	0		
6	TSARGUSH Denis (RUS)		6	3	RUS	P1	P2	P3	6	3	RUS	P1	P2	P3		
				10		6	4	0		4		6	3	0		
7	RANTALA R. (FIN)	P1	P2	P3	7	0	FIN	P1	P2	P3	9	0	HUN	P1	P2	P3
		1	3	0				0	0	0				0	0	0
8	MARTINEZ NAVARRO A. (ESP)	P1	P2	P3	7	0	FIN	P1	P2	P3	9	0	HUN	P1	P2	P3
		1	1	0				0	0	0				0	0	0
9	HATOS Gabor (HUN)	P1	P2	P3	9	3	HUN	P1	P2	P3	9	0	HUN	P1	P2	P3
		2	3	0				2	5	0				2	5	0
10	HANI Elar (EST)	P1	P2	P3	9	3	HUN	P1	P2	P3	9	0	HUN	P1	P2	P3
		0	0	0				2	5	0				2	5	0
11	BAGHDASARYAN G. (CZE)	P1	P2	P3	12	0	FRA	P1	P2	P3	14	3	AZE	P1	P2	P3
		0	0	0				0	0	0				4	0	2
12	LAMPIS Luca Ezio (FRA)	P1	P2	P3	12	0	FRA	P1	P2	P3	14	3	AZE	P1	P2	P3
		3	4	0				0	0	0				4	0	2
13	SOBIERAJ A. (POL)	P1	P2	P3	14	3	AZE	P1	P2	P3	14	3	AZE	P1	P2	P3
		0	2	0				2	1	0				2	1	0
14	GOSTIEV A. (AZE)	P1	P2	P3	14	3	AZE	P1	P2	P3	14	0	AZE	P1	P2	P3
		1	2	0				2	1	0				0	0	0
15	DYKUN Myroslav (GBR)	P1	P2	P3	15	1	GBR	P1	P2	P3	17	1	ARM	P1	P2	P3
		0	0	0				0	1	0				0	1	1
16	GRAF Steven (SUI)	P1	P2	P3	15	1	GBR	P1	P2	P3	17	1	ARM	P1	P2	P3
		0	0	0				0	1	0				0	1	1
17	MURTAZALIEV Musa (ARM)	P1	P2	P3	17	3	ARM	P1	P2	P3	17	3	ARM	P1	P2	P3
		2	3	0				3	2	0				3	2	0
18	ATOFANI M. (ROU)	P1	P2	P3	17	3	ARM	P1	P2	P3	17	3	ARM	P1	P2	P3
		0	1	0				3	2	0				3	2	0
19	KHUTSISHVILI Davit (GEO)	P1	P2	P3	19	3	GEO	P1	P2	P3	19	3	GEO	P1	P2	P3
		1	1	0				2	6	0				2	6	0
20	DEMIRTAS Soner (TUR)	P1	P2	P3	19	3	GEO	P1	P2	P3	19	3	GEO	P1	P2	P3
		0	0	0				2	6	0				2	6	0
21	PALINKAS Dan (SVK)	P1	P2	P3	19	3	GEO	P1	P2	P3	19	3	GEO	P1	P2	P3
		0	1	0				2	6	0				2	6	0
22	ERGUN Aydin (GER)	P1	P2	P3	22	0	GER	P1	P2	P3	19	3	GEO	P1	P2	P3
		1	4	0				0	0	0				1	2	0
23	DERMENJI Roman (MDA)	P1	P2	P3	22	0	GER	P1	P2	P3	19	3	GEO	P1	P2	P3
		4	6	0				0	0	0				1	1	0
24	STAJER Valdemar (SRB)	P1	P2	P3	23	0	MDA	P1	P2	P3	25	0	BUL	P1	P2	P3
		0	0	0				0	0	0				0	0	0
25	TERZIEV K. (BUL)	P1	P2	P3	23	0	MDA	P1	P2	P3	25	0	BUL	P1	P2	P3
		2	4	0				0	0	0				0	0	0
26	LUMIA Carmelo (ITA)	P1	P2	P3	25	3	BUL	P1	P2	P3	25	0	BUL	P1	P2	P3
		0	0	0				8	1	0				0	0	0

6 TSARGUSH Denis (RUS)

Classement

Cl	Pays	Nom
1	RUS	TSARGUSH Denis
2	GEO	KHUTSISHVILI Davit
3	HUN	HATOS Gabor
3	AZE	GOSTIEV A.
5	UKR	BILOTSERKIVSKYI O.
5	TUR	DEMIRTAS Soner
7	BUL	TERZIEV K.
8	ARM	MURTAZALIEV Musa
9	GBR	DYKUN Myroslav
10	MDA	DERMENJI Roman
11	FRA	LAMPIS Luca Ezio
12	MKD	VRENEZI Ljuljzim
13	GER	ERGUN Aydin
14	FIN	RANTALA R.
15	POL	SOBIERAJ A.
16	ESP	MARTINEZ NAVARRO A.
17	SVK	PALINKAS Dan
17	ROU	ATOFANI M.
19	AUT	CREPAZ Philipp
20	SUI	GRAF Steven
21	BLR	AFANASYEU Anton
22	EST	HANI Elar
23	ITA	LUMIA Carmelo
24	CZE	BAGHDASARYAN Gurgun
25	SRB	STAJER Valdemar
26	GRE	MATSALIN Oleg

REPECHAGE

REPECHAGE FINALISTE 1

5	0	GRE	P1	P2	P3	9	3	HUN	P1	P2	P3
	0		0	0	0		2		1	1	0
9	3	HUN	P1	P2	P3	4	0	UKR	P1	P2	P3
	3		1	2	0		0		0	0	0

9 HATOS Gabor (HUN)

Médaille de Bronze

REPECHAGE FINALISTE 2

20	3	TUR	P1	P2	P3	20	3	TUR	P1	P2	P3
	10		3	7	0		3		1	2	0
22	0	GER	P1	P2	P3	25	0	BUL	P1	P2	P3
	0		0	0	0		0		0	0	0

14 GOSTIEV A. (AZE)

Médaille de Bronze



Classement

Senior European Championship 2012

STYLE : FS 74 kg



1 - Or / Gold

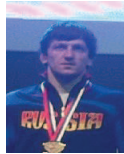

TSARGUSH Denis

2 - Argent / Silver



KHUTSISHVILI Davit

3 - Bronze

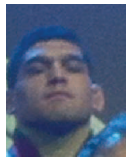

HATOS Gabor



GOSTIEV Alexander Taymurazovic

Classement	Nom - Name	Pays - Country
1	TSARGUSH Denis	RUS
2	KHUTSISHVILI Davit	GEO
3	HATOS Gabor	HUN
3	GOSTIEV A.	AZE
5	BILOTSEKIVSKYI O.	UKR
5	DEMIRTAS Soner	TUR
7	TERZIEV K.	BUL
8	MURTAZALIEV Musa	ARM
9	DYKUN Myroslav	GBR
10	DERMENJI Roman	MDA
11	LAMPIS Luca Ezio	FRA
12	VRENEZI Ljulzim	MKD
13	ERGUN Aydin	GER
14	RANTALA R.	FIN
15	SOBIERAJ A.	POL
16	MARTINEZ NAVARRO A.	ESP
17	PALINKAS Dan	SVK
17	ATOFANI M.	ROU
19	CREPAZ Philipp	AUT
20	GRAF Steven	SUI
21	AFANASYEU Anton	BLR
22	HANI Elar	EST
23	LUMIA Carmelo	ITA
24	BAGHDASARYAN Gurgen	CZE
25	STAJER Valdemar	SRB
26	MATSALIN Oleg	GRE



Feuille de compétition / Competition Sheet

Senior European Championship 2012



STYLE : FS 84 kg

QUALIFICATION			1/8 FINALE			1/4 FINALE			1/2 FINALE			FINALE		
1	ZVIRBULIS Armands (LAT)		1	LAT	3/3	1	LAT	3/3	1	LAT	1/1	6	BUL	0/0
2	MARCZINSKI S. (FRA)		2	FRA	1/1	2	FRA	1/1	2	FRA	1/1	6	BUL	0/0
3	GURMUZACHI Ion (MDA)		3	MDA	1/10	3	MDA	1/10	3	MDA	1/10	6	BUL	0/0
4	TSOTADZE Dzhambuli (UKR)		4	UKR	3/14	4	UKR	3/14	4	UKR	3/14	6	BUL	0/0
5	VOLK Konstantin (GER)		5	GER	0/0	5	GER	0/0	5	GER	0/0	6	BUL	0/0
6	GANEV M. (BUL)	P1/P2/P3 3/6/4	6	BUL	3/2	6	BUL	3/2	6	BUL	3/2	6	BUL	3/2
7	AKKERMAN Ivante (GBR)	P1/P2/P3 0/0/0	7	GBR	0/0	7	GBR	0/0	7	GBR	0/0	6	BUL	3/2
8	SHALA Egzon (ALB)	P1/P2/P3 1/1/1	8	ALB	1/1	8	ALB	1/1	8	ALB	1/1	6	BUL	3/2
9	URISHEV Anzor (RUS)	P1/P2/P3 3/10/5	9	RUS	3/4	9	RUS	3/4	9	RUS	3/4	6	BUL	3/2
10	NURMAGOMEDOV G. (ARM)	P1/P2/P3 3/9/4	10	ARM	3/9	10	ARM	3/9	10	ARM	3/9	6	BUL	3/2
11	VOITECHOVSKIS E. (LTU)	P1/P2/P3 1/2/2	11	LTU	1/2	11	LTU	1/2	11	LTU	1/2	6	BUL	3/2
12	BALAWENDER M. (POL)	P1/P2/P3 3/3/1	12	POL	0/0	12	POL	0/0	12	POL	0/0	6	BUL	3/2
13	RIESEN Marco Lukas (SUI)	P1/P2/P3 1/1/0	13	SUI	1/1	13	SUI	1/1	13	SUI	1/1	6	BUL	3/2
14	MAHAMEDAU Amarhajy (BLR)	P1/P2/P3 3/6/3	14	BLR	3/4	14	BLR	3/4	14	BLR	3/4	6	BUL	3/2
15	DOLLY A. (IRL)	P1/P2/P3 1/1/0	15	IRL	1/1	15	IRL	1/1	15	IRL	1/1	6	BUL	3/2
16	KHAMIKOYEV Ilya (AZE)	P1/P2/P3 0/0/0	16	AZE	0/0	16	AZE	0/0	16	AZE	0/0	6	BUL	3/2
17	BOKE Serdar (TUR)	P1/P2/P3 3/2/1	17	TUR	3/8	17	TUR	3/8	17	TUR	3/8	6	BUL	3/2
18	KOLESNICOV Sergei (ISR)	P1/P2/P3 5/0/0	18	ISR	1/3	18	ISR	1/3	18	ISR	1/3	6	BUL	3/2
19	VEREB Istvan (HUN)	P1/P2/P3 0/4/3	19	HUN	0/4	19	HUN	0/4	19	HUN	0/4	6	BUL	3/2
20	BOGDANOV Dejan (MKD)	P1/P2/P3 0/0/0	20	MKD	0/0	20	MKD	0/0	20	MKD	0/0	6	BUL	3/2
21	MARSAGISHVILI Dato (GEO)	P1/P2/P3 3/4/1	21	GEO	5/7	21	GEO	5/7	21	GEO	5/7	6	BUL	3/2
22	ANDONOV Boris (ESP)	P1/P2/P3 3/3/1	22	ESP	0/0	22	ESP	0/0	22	ESP	0/0	6	BUL	3/2
23	SORBELLO Andrea (ITA)	P1/P2/P3 0/0/0	23	ITA	0/0	23	ITA	0/0	23	ITA	0/0	6	BUL	3/2
24	DUKIC Dragutin (SRB)	P1/P2/P3 1/1/0	24	SRB	1/1	24	SRB	1/1	24	SRB	1/1	6	BUL	3/2
25	XENIDIS Timofei (GRE)	P1/P2/P3 4/15/8	25	GRE	1/3	25	GRE	1/3	25	GRE	1/3	6	BUL	3/2
26	STEFAN Gheorghita (ROU)	P1/P2/P3 3/5/4	26	ROU	3/9	26	ROU	3/9	26	ROU	3/9	6	BUL	3/2
27	MATEJOV RenA© (SVK)	P1/P2/P3 0/0/0	27	SVK	0/0	27	SVK	0/0	27	SVK	0/0	6	BUL	3/2

21 MARSAGISHVILI Dato (GEO)

Classement

Cl	Pays	Nom
1	GEO	MARSAGISHVILI Dato
2	BUL	GANEV Mihail Petrov
3	RUS	URISHEV Anzor
3	ROU	STEFAN Gheorghita
5	LAT	ZVIRBULIS Armands
5	TUR	BOKE Serdar
7	BLR	MAHAMEDAU Amarhajy
8	ISR	KOLESNICOV Sergei
9	GRE	XENIDIS Timofei
10	UKR	TSOTADZE Dzhambuli
11	ARM	NURMAGOMEDOV G.
12	GER	VOLK Konstantin
13	MKD	BOGDANOV Dejan
14	POL	BALAWENDER M.
15	ESP	ANDONOV Boris
16	MDA	GURMUZACHI Ion
17	LTU	VOITECHOVSKIS E.
18	FRA	MARCZINSKI S.
18	SUI	RIESEN Marco Lukas
20	IRL	DOLLY A.
21	ALB	SHALA Egzon
22	SRB	DUKIC Dragutin
23	GBR	AKKERMAN Ivante
24	HUN	VEREB Istvan
25	AZE	KHAMIKOYEV Ilya
26	ITA	SORBELLO Andrea
27	SVK	MATEJOV RenA©

REPECHAGE

REPECHAGE FINALISTE 1

7	GBR	P1/P2/P3 1/0/0	5	GER	P1/P2/P3 1/1/0	9	RUS	P1/P2/P3 3/7/4
5	GER	P1/P2/P3 3/6/4	9	RUS	P1/P2/P3 3/6/2	1	LAT	P1/P2/P3 0/0/0

9 URISHEV Anzor (RUS)

Médaille de Bronze

REPECHAGE FINALISTE 2

20	MKD	P1/P2/P3 3/2/1	20	MKD	P1/P2/P3 1/4/3	26	ROU	P1/P2/P3 3/2/1
22	ESP	P1/P2/P3 0/0/0	26	ROU	P1/P2/P3 3/6/1	17	TUR	P1/P2/P3 0/0/0

26 STEFAN Gheorghita (ROU)

Médaille de Bronze



Classement

Senior European Championship 2012

STYLE : FS 84 kg



1 - Or / Gold

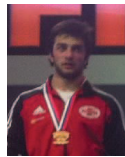

MARSAGISHVILI Dato

2 - Argent / Silver

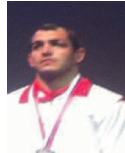

GANEV Mihail Petrov

3 - Bronze

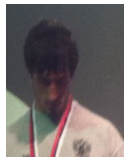

URISHEV Anzor

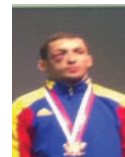

STEFAN Gheorghita

Classement	Nom - Name	Pays - Country
1	MARSAGISHVILI Dato	GEO
2	GANEV Mihail Petrov	BUL
3	URISHEV Anzor	RUS
3	STEFAN Gheorghita	ROU
5	ZVIRBULIS Armands	LAT
5	BOKE Serdar	TUR
7	MAHAMEDAU Amarhajy	BLR
8	KOLESNICOV Sergei	ISR
9	XENIDIS Timofei	GRE
10	TSOTADZE Dzhambuli	UKR
11	NURMAGOMEDOV G.	ARM
12	VOLK Konstantin	GER
13	BOGDANOV Dejan	MKD
14	BALAWENDER M.	POL
15	ANDONOV Boris	ESP
16	GURMUZACHI Ion	MDA
17	VOITECHOVSKIS E.	LTU
18	MARCZINSKI S.	FRA
18	RIESEN Marco Lukas	SUI
20	DOLLY A.	IRL
21	SHALA Egzon	ALB
22	DUKIC Dragutin	SRB
23	AKKERMAN Ivante	GBR
24	VEREB Istvan	HUN
25	KHAMIKOYEV Ilya	AZE
26	SORBELLO Andrea	ITA
27	MATEJOV RenÅ©	SVK



Feuille de compétition / Competition Sheet

Senior European Championship 2012



STYLE : FS 96 kg

QUALIFICATION		1/8 FINALE	1/4 FINALE	1/2 FINALE	FINALE
1	KRIARIDIS G. (GRE)	1 1 2 GRE	2 1 3 AZE	4 3 3 UKR	4 0 0 UKR
2	TEMREZOV Nauruz (AZE)	2 3 9 AZE	4 3 5 UKR	4 3 3 UKR	4 0 0 UKR
3	JOVANOVIC Marko (SRB)	3 0 0 SRB	4 3 5 UKR	4 3 3 UKR	4 0 0 UKR
4	ANDRIITSEV Valerii (UKR)	4 4 13 UKR	4 3 5 UKR	4 3 3 UKR	4 0 0 UKR
5	GOGSHELIDZE George (GEO)	5 3 5 GEO	5 1 6 GEO	5 1 6 GEO	5 1 6 GEO
6	CEBAN Nicolai (MDA)	6 1 2 MDA	6 1 2 MDA	6 1 2 MDA	6 1 2 MDA
7	BALCI Serhat (TUR)	7 3 4 TUR	7 3 4 TUR	7 3 4 TUR	7 3 4 TUR
8	LAGODSKIS Imants (LAT)	8 0 0 LAT	8 0 0 LAT	8 0 0 LAT	8 0 0 LAT
9	GALSTYAN Andranik (ARM)	9 1 3 ARM	9 1 3 ARM	9 1 3 ARM	9 1 3 ARM
10	FODOR Tamas (HUN)	10 3 5 HUN	10 3 5 HUN	10 3 5 HUN	10 3 5 HUN
11	SCHWAEBE Kevin (GER)	11 1 3 GER	11 1 3 GER	11 1 3 GER	11 1 3 GER
12	YANKOUSKI Ivan (BLR)	12 3 9 BLR	12 3 9 BLR	12 3 9 BLR	12 3 9 BLR
13	JALOVJAR Jozef (SVK)	13 1 1 SVK	13 1 1 SVK	13 1 1 SVK	13 1 1 SVK
14	VARNTAN Aparian (CYP)	14 0 0 CYP	14 0 0 CYP	14 0 0 CYP	14 0 0 CYP
15	SREDKOV G. (BUL)	15 3 3 BUL	15 3 3 BUL	15 3 3 BUL	15 3 3 BUL
16	RATTIGAN L. (GBR)	16 1 2 GBR	16 1 2 GBR	16 1 2 GBR	16 1 2 GBR
17	GADISOV Abdusalam (RUS)	17 3 5 RUS	17 3 5 RUS	17 3 5 RUS	17 3 5 RUS
18	BARAN Radoslaw (POL)	18 0 0 POL	18 0 0 POL	18 0 0 POL	18 0 0 POL
19	STOJANOV A. (MKD)	19 1 1 MKD	19 1 1 MKD	19 1 1 MKD	19 1 1 MKD
20	RECOREAN Adrian (ROU)	20 3 6 ROU	20 3 6 ROU	20 3 6 ROU	20 3 6 ROU

17 GADISOV Abdusalam (RUS)

Classement

Cl	Pays	Nom
1	RUS	GADISOV Abdusalam
2	UKR	ANDRIITSEV Valerii
3	TUR	BALCI Serhat
3	BLR	YANKOUSKI Ivan
5	AZE	TEMREZOV Nauruz
5	POL	BARAN Radoslaw
7	BUL	SREDKOV G.
8	SVK	JALOVJAR Jozef
9	GEO	GOGSHELIDZE George
10	ROU	RECOREAN Adrian
11	HUN	FODOR Tamas
12	ARM	GALSTYAN Andranik
13	GER	SCHWAEBE Kevin
14	GBR	RATTIGAN L.
15	MDA	CEBAN Nicolai
16	GRE	KRIARIDIS Grigorios
17	MKD	STOJANOV Aleksandar
18	CYP	VARNTAN Aparian
19	LAT	LAGODSKIS Imants
20	SRB	JOVANOVIC Marko

REPECHAGE	
REPECHAGE FINALISTE 1	
3 0 0 SRB	2 1 1 AZE
2 5 8 AZE	7 3 2 TUR
7 BALCI Serhat (TUR)	
Médaille de Bronze	
REPECHAGE FINALISTE 2	
18 3 6 POL	18 3 4 POL
20 1 2 ROU	15 1 4 BUL
18 0 0 POL	12 3 2 BLR
12 YANKOUSKI Ivan (BLR)	
Médaille de Bronze	



Classement

Senior European Championship 2012

STYLE : FS 96 kg



1 - Or / Gold

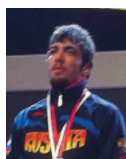

GADISOV Abdusalam

2 - Argent / Silver

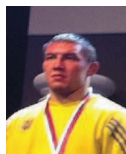

ANDRIITSEV Valerii

3 - Bronze

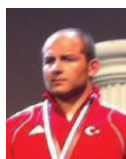

BALCI Serhat

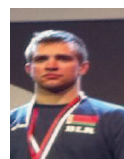

YANKOUSKI Ivan

Classement	Nom - Name	Pays - Country
1	GADISOV Abdusalam	RUS
2	ANDRIITSEV Valerii	UKR
3	BALCI Serhat	TUR
3	YANKOUSKI Ivan	BLR
5	BARAN Radoslaw	POL
5	TEMREZOV Nauruz	AZE
7	SREDKOV G.	BUL
8	JALOVIAR Jozef	SVK
9	GOGSHELIDZE George	GEO
10	RECOREAN Adrian	ROU
11	FODOR Tamas	HUN
12	GALSTYAN Andranik	ARM
13	SCHWAEBE Kevin	GER
14	RATTIGAN L.	GBR
15	CEBAN Nicolai	MDA
16	KRIARIDIS Grigorios	GRE
17	STOJANOV Aleksandar	MKD
18	VARNTAN Aparian	CYP
19	LAGODSKIS Imants	LAT
20	JOVANOVIC Marko	SRB



Feuille de compétition / Competition Sheet

Senior European Championship 2012



STYLE : FS 120 kg

QUALIFICATION		1/8 FINALE	1/4 FINALE	1/2 FINALE	FINALE
1	MODZMANASHVILI D. (GEO)	1 1 9 GEO	P1 P2 P3 0 1 8		
2	LIGETI Daniel (HUN)	2 3 8 HUN	P1 P2 P3 1 0 7		
3	HUTNAN Marian (SVK)	3 0 2 SVK	P1 P2 P3 2 0 0		
4	CUBA VAZQUEZ Jose (ESP)	4 5 2 ESP	P1 P2 P3 0 2 0		
5	ROMANOV Alexandr (MDA)	5 1 3 MDA	P1 P2 P3 2 1 0		
6	KUMCHEV D. (BUL)	6 3 9 BUL	P1 P2 P3 4 5 0		
7	BASIEV Ruslan (ARM)	7 0 0 ARM	P1 P2 P3 0 0 0		
8	MAGOMEDOV J. (AZE)	8 3 3 AZE	P1 P2 P3 1 2 0		
9	BARTNICKI B. (POL)	9 0 0 POL	P1 P2 P3 0 0 0		
10	DZIATKO Ihar (BLR)	10 3 2 BLR	P1 P2 P3 1 1 0		
11	GEORGIEV A. (MKD)	11 0 0 MKD	P1 P2 P3 0 0 0		
12	BARO Fatjon (ALB)	12 5 8 ALB	P1 P2 P3 4 4 0		
13	MATUHIN Nick (GER)	13 5 5 GER	P1 P2 P3 3 2 0		
14	GIAGIAS Statis (GRE)	14 0 2 GRE	P1 P2 P3 1 1 0		
15	AKGUL Taha (TUR)	15 3 8 TUR	P1 P2 P3 2 6 0		
16	BUDIC Predrag (SRB)	16 1 3 SRB	P1 P2 P3 0 3 0		
17	MIHAILOVS Dmitrijs (LAT)	17 0 2 LAT	P1 P2 P3 2 0 0		
18	CHINTOAN R. (ROU)	18 5 15 ROU	P1 P2 P3 9 6 0		
19	KHOTSIANIVSKIY O. (UKR)	19 1 2 UKR	P1 P2 P3 0 2 0		
20	AKHMEDOV Bakhtiyar (RUS)	20 3 5 RUS	P1 P2 P3 1 4 0		
				2 3 8 HUN	P1 P2 P3 3 5 0
			4 1 2 ESP	P1 P2 P3 1 1 0	
			6 5 4 BUL	P1 P2 P3 4 0 0	
			8 0 1 AZE	P1 P2 P3 1 0 0	
			10 3 3 BLR	P1 P2 P3 2 0 1	
			12 1 1 ALB	P1 P2 P3 0 1 0	
			15 5 0 TUR	P1 P2 P3 0 0 0	
			20 0 0 RUS	P1 P2 P3 0 0 0	
				2 1 2 HUN	P1 P2 P3 0 2 0
				6 1 1 BUL	P1 P2 P3 0 1 0
				10 0 0 BLR	P1 P2 P3 0 0 0
				15 3 6 TUR	P1 P2 P3 3 3 0
					15 AKGUL Taha (TUR)

Classement

Cl	Pays	Nom
1	TUR	AKGUL Taha
2	HUN	LIGETI Daniel
3	GEO	MODZMANASHVILI D.
3	BLR	DZIATKO Ihar
5	BUL	KUMCHEV D.
5	GER	MATUHIN Nick
7	RUS	AKHMEDOV Bakhtiyar
8	ALB	BARO Fatjon
9	ESP	CUBA VAZQUEZ Jose
10	ROU	CHINTOAN R.
11	AZE	MAGOMEDOV J.
12	MDA	ROMANOV Alexandr
13	SRB	BUDIC Predrag
14	UKR	KHOTSIANIVSKIY O.
15	SVK	HUTNAN Marian
16	GRE	GIAGIAS Statis
17	LAT	MIHAILOVS Dmitrijs
18	POL	BARTNICKI B.
19	ARM	BASIEV Ruslan
20	MKD	GEORGIEV Aleksandar

REPECHAGE

REPECHAGE FINALISTE 1

1 4 12	GEO	P1 P2 P3 6 6 0		1 3 9	GEO	P1 P2 P3 2 7 0
4 0 0	ESP	P1 P2 P3 0 0 0		6 0 0	BUL	P1 P2 P3 0 0 0
1 MODZMANASHVILI D. (GEO)						

Médaille de Bronze

REPECHAGE FINALISTE 2

16 0 0	SRB	P1 P2 P3 0 0 0		13 5 0	GER	P1 P2 P3 0 0 0
13 3 12	GER	P1 P2 P3 5 7 0		20 0 0	RUS	P1 P2 P3 0 0 0
				13 1 2	GER	P1 P2 P3 2 0 0
				10 3 3	BLR	P1 P2 P3 0 2 1
10 DZIATKO Ihar (BLR)						

Médaille de Bronze

Classement**Senior European Championship 2012**

STYLE : FS 120 kg

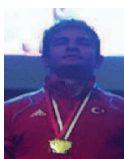
**1 - Or / Gold**

AKGUL Taha

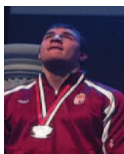
2 - Argent / Silver

LIGETI Daniel

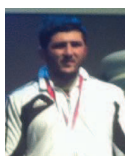
3 - Bronze

MODZMANASHVILI Davit

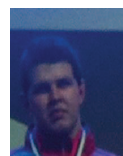

DZIATKO Ihar

<i>Classement</i>	<i>Nom - Name</i>	<i>Pays - Country</i>
1	AKGUL Taha	TUR
2	LIGETI Daniel	HUN
3	MODZMANASHVILI D.	GEO
3	DZIATKO Ihar	BLR
5	MATUHIN Nick	GER
5	KUMCHEV D.	BUL
7	AKHMEDOV Bakhtiyar	RUS
8	BARO Fatjon	ALB
9	CUBA VAZQUEZ Jose	ESP
10	CHINTOAN R.	ROU
11	MAGOMEDOV J.	AZE
12	ROMANOV Alexandr	MDA
13	BUDIC Predrag	SRB
14	KHOTSIANIVSKYI O.	UKR
15	HUTNAN Marian	SVK
16	GIAGIAS Stasis	GRE
17	MIHAILOVS Dmitrijs	LAT
18	BARTNICKI B.	POL
19	BASIEV Ruslan	ARM
20	GEORGIEV Aleksandar	MKD

**Classement par équipe / Teams ranking****Senior European Championship 2012**

STYLE FS

Rang	Equipe	120 KG	55 KG	60 KG	66 KG	74 KG	84 KG	96 KG	TOTAL
1	RUS	4	10	8	10	10	8	10	60
2	GEO	8	9	8	6	9	10	2	52
3	BUL	6	8	9	9	4	9	4	49
4	TUR	10	8		6	6	6	8	44
5	UKR		4	6	4	6	1	9	30
6	BLR	8	3	4	1		4	8	28
7	HUN	9	2		8	8			27
8	AZE			10	2	8		6	26
9	ARM		6	2	8	3			19
10	ROU	1		6			8	1	16
11	GER	6		3					9
12	MDA		6	1		1			8
13	POL		1					6	7
14	LAT						6		6
15	ALB	3							3
16	ISR						3		3
17	ITA				3				3
18	SVK							3	3
19	ESP	2							2
20	GBR					2			2
21	GRE						2		2
22	AUT								0
22	CYP								0
22	CZE								0
22	EST								0
22	FIN								0
22	FRA								0
22	IRL								0
22	LTU								0
22	MKD								0
22	MON								0
22	SRB								0
22	SUI								0

SENIOR EUROPEAN CHAMPIONSHIP - BELGRADE 2012



BELGRADE (SRB)

2012 - 03 - 06 - 2012 - 03- 12

Résultats - Results

Female wrestling





Raphael Marineti

President FILA

TzenoTzenov

President CEL

Kim Ik-Jong (UZB)

Techical delegate

Ruziev Akhro (KOR)

Tehical delegate

IantchoKostandinov (BUL)

FILA Instructor

AyikAhmet (TUR)

Vice-President FILA

Stan Dziedic (USA)

Vice-President FILA

DrPelliconeMatteo (ITA)

Vice-President FILA

Michel Dusson (FRA)

General Secretary FILA

NamigAliyev (AZE)

FILA Bureau member

TheodorosHamakos (GRE)

FILA Bureau member

CsabaHegedus (HUN)

FILA Bureau member

NenadLalovic (SRB)

FILA Bureau member

Mikhail Mamiashvili (RUS)

FILA Bureau member

Rodica Maia Yaksi (TUR)

FILA Bureau member

ZeljkoTrajkovic

President Wrestling Federation of Serbia

Rajko Baltic

Director ECH – Belgrad 2012.



Liste des équipes / Teams List

Senior European Championship 2012

STYLE FW



Equipes - Teams

	ALLEMAGNE	GER
	ARMENIE	ARM
	AUTRICHE	AUT
	AZERBAIDJAN	AZE
	BELARUS	BLR
	BULGARIE	BUL
	ESPAGNE	ESP
	ESTONIE	EST
	FINLANDE	FIN
	FRANCE	FRA
	GRANDE BRETAGNE	GBR
	GRECE	GRE
	HOLLANDE	NED
	HONGRIE	HUN
	ISRAEL	ISR
	ITALIE	ITA
	LETONIE	LAT
	LITUANIE	LTU
	MOLDAVIE	MDA
	MONTENEGRO	MNE
	NORVEGE	NOR
	POLOGNE	POL
	PORTUGAL	POR
	ROUMANIE	ROU
	RUSSIE	RUS
	SERBIA	SRB
	SLOVAQUIE	SVK
	SUEDE	SWE
	SUISSE	SUI
	TCHEQUE REP.	CZE
	TURQUIE	TUR
	UKRAINE	UKR

Nombre d'équipes - Number of Teams

32

**Nombre d'engagés par équipe / Number of Entries By Team****Senior European Championship 2012****STYLE FW**

Equipe - Teams	48 KG	51 KG	55 KG	59 KG	63 KG	67 KG	72 KG	TOTAL
ARM							1	1
AUT					1	1	1	3
AZE	1	1	1	1	1	1	1	7
BLR	1	1	1	1	1	1	1	7
BUL	1				1	1	1	4
CZE			1		1			2
ESP		1			1	1	1	4
EST				1			1	2
FIN	1		1					2
FRA		1	1		1		1	4
GBR					1		1	2
GER	1	1	1	1	1	1	1	7
GRE			1		1		1	3
HUN	1		1	1			1	4
ISR						1		1
ITA	1	1	1		1		1	5
LAT		1		1	1	1		4
LTU	1							1
MDA		1	1	1				3
MNE				1				1
NED		1						1
NOR	1				1		1	3
POL	1	1	1	1	1			5
POR	1		1					2
ROU	1	1	1	1	1	1	1	7
RUS	1	1	1	1	1	1	1	7
SRB	1	1	1	1	1	1	1	7
SUI		1	1	1				3
SVK	1							1
SWE	1	1	1	1	1	1	1	7
TUR		1	1	1	1	1	1	6
UKR	1	1	1	1	1	1	1	7
TOTAL	17	17	19	16	20	14	20	123

Nombre de nations - Number of Countries **32**



Feuille de compétition / Competition Sheet

Senior European Championship 2012



STYLE : FW 48 kg

QUALIFICATION		1/8 FINALE		1/4 FINALE		1/2 FINALE		FINALE		
1	SLATTUM Henriette (NOR)	1	0 NOR	P1 P2 P3 0 0 0	2	4 ROU	P1 P2 P3 6 7 0	2	3 ROU	P1 P2 P3 3 6 0
2	DOBRE Estera (ROU)	2	3 ROU	P1 P2 P3 7 3 0	3	0 AZE	P1 P2 P3 0 0 0	2	0 ROU	P1 P2 P3 1 1 3
3	BAGOMEDOVA M. (AZE)	3	4 AZE	P1 P2 P3 8 6 0	5	3 RUS	P1 P2 P3 1 1 0	5	1 RUS	P1 P2 P3 2 0 0
4	PUIDAITE Vaida (LTU)	4	1 LTU	P1 P2 P3 2 0 0	6	0 SWE	P1 P2 P3 0 0 0	5	2 RUS	P1 P2 P3 2 0 0
5	VILMOVA Marina (RUS)	5	3 RUS	P1 P2 P3 3 4 0	7	1 BLR	P1 P2 P3 0 1 0	9	5 UKR	P1 P2 P3 6 4 0
6	JEPPSSON V. (SWE)	6	0 SWE	P1 P2 P3 0 0 0	8	0 ITA	P1 P2 P3 0 0 0	9	3 UKR	P1 P2 P3 2 1 0
7	KALADZINSKAYA V. (BLR)	7	1 BLR	P1 P2 P3 0 1 0	9	3 UKR	P1 P2 P3 2 1 0	9	0 HUN	P1 P2 P3 0 0 0
8	FELICE Silvia (ITA)	8	3 ITA	P1 P2 P3 1 1 0	11	0 HUN	P1 P2 P3 0 0 0	9	5 UKR	P1 P2 P3 6 4 0
9	BALUSHKA Lyudmyla (UKR)	9	5 UKR	P1 P2 P3 7 0 0	12	1 FIN	P1 P2 P3 1 1 0	9	6 UKR	P1 P2 P3 2 0 4
10	JOLICIC Bojana (SRB)	10	0 SRB	P1 P2 P3 0 0 0	13	0 POR	P1 P2 P3 0 0 0	14	3 GER	P1 P2 P3 1 0 1
11	DENES Mercedesz (HUN)	11	3 HUN	P1 P2 P3 2 1 0	14	3 GER	P1 P2 P3 2 1 0	14	0 GER	P1 P2 P3 0 3 0
12	SAVOLA S. (FIN)	12	1 FIN	P1 P2 P3 1 1 0	15	0 SVK	P1 P2 P3 0 0 0	17	1 POL	P1 P2 P3 0 1 0
13	COSTA DOS SANTOS L. (POR)	13	0 POR	P1 P2 P3 0 0 0	17	3 POL	P1 P2 P3 1 3 0			
14	SCHELLIN J. (GER)	14	3 GER	P1 P2 P3 2 1 0						
15	MATEJOVA Lenka (SVK)	15	0 SVK	P1 P2 P3 0 0 0						
16	YANKOVA E. (BUL)	16	1 YANKOVA E. (BUL)	P1 P2 P3 0 2 0						
17	LUKASIAK Anna (POL)	17	3 LUKASIAK Anna (POL)	P1 P2 P3 1 1 1						

9 BALUSHKA Lyudmyla (UKR)

Classement

Cl	Pays	Nom
1	UKR	BALUSHKA Lyudmyla
2	ROU	DOBRE Estera
3	RUS	VILMOVA Marina
3	GER	SCHELLIN J.
5	NOR	SLATTUM Henriette
5	HUN	DENES Mercedesz
7	POL	LUKASIAK Anna
8	AZE	BAGOMEDOVA Marziget
9	ITA	FELICE Silvia
10	BUL	YANKOVA E.
10	FIN	SAVOLA S.
12	LTU	PUIDAITE Vaida
13	BLR	KALADZINSKAYA V.
14	POR	COSTA DOS SANTOS L.
15	SVK	MATEJOVA Lenka
16	SWE	JEPPSSON V.
17	SRB	JOLICIC Bojana

REPECHAGE

REPECHAGE FINALISTE 1

1	5 NOR	P1 P2 P3 0 3 0	1	1 NOR	P1 P2 P3 0 1 0
3	0 AZE	P1 P2 P3 2 1 0	5	3 RUS	P1 P2 P3 4 2 0
5 VILMOVA Marina (RUS)					

Médaille de Bronze

REPECHAGE FINALISTE 2

10	0 SRB	P1 P2 P3 0 0 0	11	0 HUN	P1 P2 P3 0 0 0
11	5 HUN	P1 P2 P3 6 0 0	14	3 GER	P1 P2 P3 1 1 0
14 SCHELLIN J. (GER)					

Médaille de Bronze

Classement**Senior European Championship 2012**

STYLE : FW 48 kg

**1 - Or / Gold**

BALUSHKA Lyudmyla

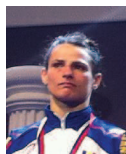
2 - Argent / Silver

DOBRE Estera

3 - Bronze

VILMOVA Marina



SCHELLIN Jaqueline Saskia

<i>Classement</i>	<i>Nom - Name</i>	<i>Pays - Country</i>
1	BALUSHKA Lyudmyla	UKR
2	DOBRE Estera	ROU
3	VILMOVA Marina	RUS
3	SCHELLIN J.	GER
5	SLATTUM Henriette	NOR
5	DENES Mercedesz	HUN
7	LUKASIAK Anna	POL
8	BAGOMEDOVA Marziget	AZE
9	FELICE Silvia	ITA
10	YANKOVA E.	BUL
10	SAVOLA S.	FIN
12	PUIDAITE Vaida	LTU
13	KALADZINSKAYA V.	BLR
14	COSTA DOS SANTOS L.	POR
15	MATEJOVA Lenka	SVK
16	JEPPSSON V.	SWE
17	JOLICIC Bojana	SRB



Feuille de compétition / Competition Sheet

Senior European Championship 2012



STYLE : FW 51 kg

QUALIFICATION		1/8 FINALE		1/4 FINALE		1/2 FINALE		FINALE	
1	MORI Francesca (ITA)	1	3/6 ITA	1	0/0 ITA	4	1/1 AZE	7	1/3 UKR
2	WISLER Marina (SUI)	2	0/0 SUI	4	3/3 AZE	7	3/2 UKR	13	3/3 POL
3	SERRANO BARCELO M. (ESP)	3	0/0 ESP	5	1/5 NED	12	1/1 RUS	13	3/3 POL
4	BAGOMEDOVA Patimat (AZE)	4	3/11 AZE	6	0/0 BLR	12	5/5 RUS	13	3/3 POL
5	BLASZKA J. (NED)	5	3/4 NED	7	3/5 UKR	13	5/4 POL	13	3/3 POL
6	CHYRIK Violeta (BLR)	6	0/0 BLR	8	1/1 GER	13	0/0 LAT	13	3/3 POL
7	KOGUT Oleksandra (UKR)	7	3/5 UKR	9	0/0 SWE	13	0/0 TUR	13	3/3 POL
8	ENGELHARDT DEMMEL A. (GER)	8	1/1 GER	10	0/0 FRA	13	5/5 POL	13	3/3 POL
9	PETERSSON F. (SWE)	9	0/0 SWE	11	1/7 MDA	13	0/0 TUR	13	3/3 POL
10	BOUBRYEMM V. (FRA)	10	3/5 FRA	12	3/7 RUS	13	0/0 TUR	13	3/3 POL
11	BUDU Natalia (MDA)	11	1/7 MDA	13	3/7 POL	13	0/0 TUR	13	3/3 POL
12	KRASNOVA Katya (RUS)	12	3/7 RUS	14	0/0 LAT	13	0/0 TUR	13	3/3 POL
13	MATKOWSKA I. (POL)	13	3/7 POL	15	0/6 ROU	13	0/0 TUR	13	3/3 POL
14	TJAPKO Karalina (LAT)	14	0/0 LAT	16	0/0 SRB	13	0/0 TUR	13	3/3 POL
15	MUNTEANU A. (ROU)	15	0/6 ROU	17	4/12 TUR	13	0/0 TUR	13	3/3 POL
16	TUBA Eva (SRB)	16	0/0 SRB						
17	KEBIC Burcu (TUR)	17	4/12 TUR						

13 MATKOWSKA I. (POL)

Classement

Cl	Pays	Nom
1	POL	MATKOWSKA I.
2	UKR	KOGUT Oleksandra
3	GER	ENGELHARDT DEMMEL A.
3	RUS	KRASNOVA Katya
5	AZE	BAGOMEDOVA Patimat
5	TUR	KEBIC Burcu
7	NED	BLASZKA J.
8	ITA	MORI Francesca
9	FRA	BOUBRYEMM V.
10	MDA	BUDU Natalia
11	ROU	MUNTEANU A.
12	BLR	CHYRIK Violeta
13	SWE	PETERSSON F.
14	SUI	WISLER Marina
15	ESP	SERRANO BARCELO M.
16	SRB	TUBA Eva
17	LAT	TJAPKO Karalina

REPECHAGE

REPECHAGE FINALISTE 1

8	5/6	GER	P1 P2 P3	0 0 0	8	3/2	GER	P1 P2 P3	1 1 0
5	0/0	NED	P1 P2 P3	0 0 0	4	0/0	AZE	P1 P2 P3	0 0 0

ENGELHARDT DEMMEL A. (GER)

Médaille de Bronze

REPECHAGE FINALISTE 2

14	0/0	LAT	P1 P2 P3	0 0 0	17	0/3	TUR	P1 P2 P3	3 0 0
17	4/14	TUR	P1 P2 P3	7 7 0	12	5/8	RUS	P1 P2 P3	4 4 0

12 KRASNOVA Katya (RUS)

Médaille de Bronze



Classement

Senior European Championship 2012

STYLE : FW 51 kg



1 - Or / Gold



MATKOWSKA Iwona Nina

2 - Argent / Silver



KOGUT Oleksandra

3 - Bronze



ENGELHARDT DEMMEL Alexandra KRASNOVA Katya

Classement	Nom - Name	Pays - Country
1	MATKOWSKA I.	POL
2	KOGUT Oleksandra	UKR
3	ENGELHARDT DEMMEL A.	GER
3	KRASNOVA Katya	RUS
5	BAGOMEDOVA Patimat	AZE
5	KEBIC Burcu	TUR
7	BLASZKA J.	NED
8	MORI Francesca	ITA
9	BOUBRYEMM V.	FRA
10	BUDU Natalia	MDA
11	MUNTEANU A.	ROU
12	CHYRIK Vialeta	BLR
13	PETERSSON F.	SWE
14	WISLER Marina	SUI
15	SERRANO BARCELO M.	ESP
16	TUBA Eva	SRB
17	TJAPKO Karalina	LAT



Feuille de compétition / Competition Sheet

Senior European Championship 2012



STYLE : FW 55 kg

QUALIFICATION				1/8 FINALE				1/4 FINALE				1/2 FINALE				FINALE							
1		RATKEVICH Yuliya (AZE)		1	1	AZE	P1 P2 P3 0 1 0	2	0	RUS	P1 P2 P3 0 0 0	3	5	SWE	P1 P2 P3 4 4 0	3	1	SWE	P1 P2 P3 3 0 2	10	3	UKR	P1 P2 P3 0 3 3
2		GUROVA Maria (RUS)		2	3	RUS	P1 P2 P3 1 4 0	3	3	SWE	P1 P2 P3 3 1 0	6	3	GRE	P1 P2 P3 1 1 0	6	0	GRE	P1 P2 P3 0 0 0	10	3	UKR	P1 P2 P3 1 1 0
3		MATTSSON S. (SWE)		3	5	SWE	P1 P2 P3 4 0 0	7	0	CZE	P1 P2 P3 0 0 0	7	0	CZE	P1 P2 P3 0 0 0	10	3	UKR	P1 P2 P3 1 3 0				
4		TURCAN Elena (MDA)		4	0	MDA	P1 P2 P3 0 0 0	8	0	POR	P1 P2 P3 0 0 0	10	3	UKR	P1 P2 P3 1 3 0								
5		FRIEDRICH Eileen (GER)		5	0	GER	P1 P2 P3 0 0 0	11	1	BLR	P1 P2 P3 0 2 0	12	1	HUN	P1 P2 P3 1 3 0								
6		PREVOLARAKI Maria (GRE)		6	5	GRE	P1 P2 P3 1 4 0	12	3	HUN	P1 P2 P3 1 4 0	13	3	ROU	P1 P2 P3 5 2 0								
7		MARTINAKOVA Lenka (CZE)		7	3	CZE	P1 P2 P3 1 1 0	13	3	ROU	P1 P2 P3 5 2 0	16	3	FIN	P1 P2 P3 4 3 0								
8		GOMES GUERREIRO V. (POR)		8	0	POR	P1 P2 P3 0 0 0	14	0	FRA	P1 P2 P3 0 0 0	16	0	FIN	P1 P2 P3 0 0 0								
9		ZASINA R. (POL)		9	0	POL	P1 P2 P3 0 0 0	15	0	TUR	P1 P2 P3 0 0 0	18	4	SUI	P1 P2 P3 8 7 0								
10		SYNYSHYN Nataliya (UKR)		10	3	UKR	P1 P2 P3 1 1 0	16	3	FIN	P1 P2 P3 4 3 0	18	0	SRB	P1 P2 P3 0 0 0								
11		SHUSHKO Nadzeya (BLR)		11	1	BLR	P1 P2 P3 0 2 0	17	1	ITA	P1 P2 P3 1 0 0												
12		BARKA Emese (HUN)		12	3	HUN	P1 P2 P3 1 4 0	18	0	SUI	P1 P2 P3 0 0 0												
13		PAVAL Ana Maria (ROU)		13	3	ROU	P1 P2 P3 1 1 0																
14	3	GOMIS Anna (FRA)	P1 P2 P3 1 6 0																				
15	0	YILDIRIM Zeynep (TUR)	P1 P2 P3 0 0 0																				
16	3	OLLI Petra Maarit (FIN)	P1 P2 P3 2 1 0																				
17	1	MINGUZZI Valentina (ITA)	P1 P2 P3 1 0 0																				
18	4	TOKAR N. (SUI)	P1 P2 P3 8 7 0																				
19	0	KRCMAREVIC Jovana (SRB)	P1 P2 P3 0 0 0																				

10 SYNYSHYN Nataliya (UKR)

Classement

Cl	Pays	Nom
1	UKR	SYNYSHYN Nataliya
2	SWE	MATTSSON S.
3	RUS	GUROVA Maria
3	ROU	PAVAL Ana Maria
5	GRE	PREVOLARAKI Maria
5	POL	ZASINA R.
7	FIN	OLLI Petra Maarit
8	SUI	TOKAR Nadine Simone
9	HUN	BARKA Emese
10	FRA	GOMIS Anna
11	CZE	MARTINAKOVA Lenka
12	BLR	SHUSHKO Nadzeya
13	ITA	MINGUZZI Valentina
14	AZE	RATKEVICH Yuliya
15	POR	GOMES GUERREIRO V.
16	GER	FRIEDRICH Eileen
17	TUR	YILDIRIM Zeynep
18	MDA	TURCAN Elena
19	SRB	KRCMAREVIC Jovana

REPECHAGE			
REPECHAGE FINALISTE 1			
4	0	MDA	P1 P2 P3 0 0 0
2	3	RUS	P1 P2 P3 1 6 0
6	0	GRE	P1 P2 P3 0 0 0
2		GUROVA Maria (RUS)	
Médaille de Bronze			
REPECHAGE FINALISTE 2			
9	3	POL	P1 P2 P3 6 3 0
12	0	HUN	P1 P2 P3 2 0 0
13	3	ROU	P1 P2 P3 3 1 0
13		PAVAL Ana Maria (ROU)	
Médaille de Bronze			

Classement

Senior European Championship 2012

STYLE : FW 55 kg



1 - Or / Gold



SYNYSHYN Nataliya

2 - Argent / Silver



MATTSSON Sofia Magdalena

3 - Bronze

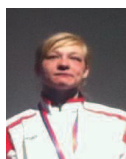

GUROVA Maria



PAVAL Ana Maria

Classement	Nom - Name	Pays - Country
1	SYNYSHYN Nataliya	UKR
2	MATTSSON S.	SWE
3	GUROVA Maria	RUS
3	PAVAL Ana Maria	ROU
5	PREVOLARAKI Maria	GRE
5	ZASINA R.	POL
7	OLLI Petra Maarit	FIN
8	TOKAR Nadine Simone	SUI
9	BARKA Emese	HUN
10	GOMIS Anna	FRA
11	MARTINAKOVA Lenka	CZE
12	SHUSHKO Nadzeya	BLR
13	MINGUZZI Valentina	ITA
14	RATKEVICH Yuliya	AZE
15	GOMES GUERREIRO V.	POR
16	FRIEDRICH Eileen	GER
17	YILDIRIM Zeynep	TUR
18	TURCAN Elena	MDA
19	KRCMAREVIC Jovana	SRB



Feuille de compétition / Competition Sheet

Senior European Championship 2012



STYLE : FW 59 kg

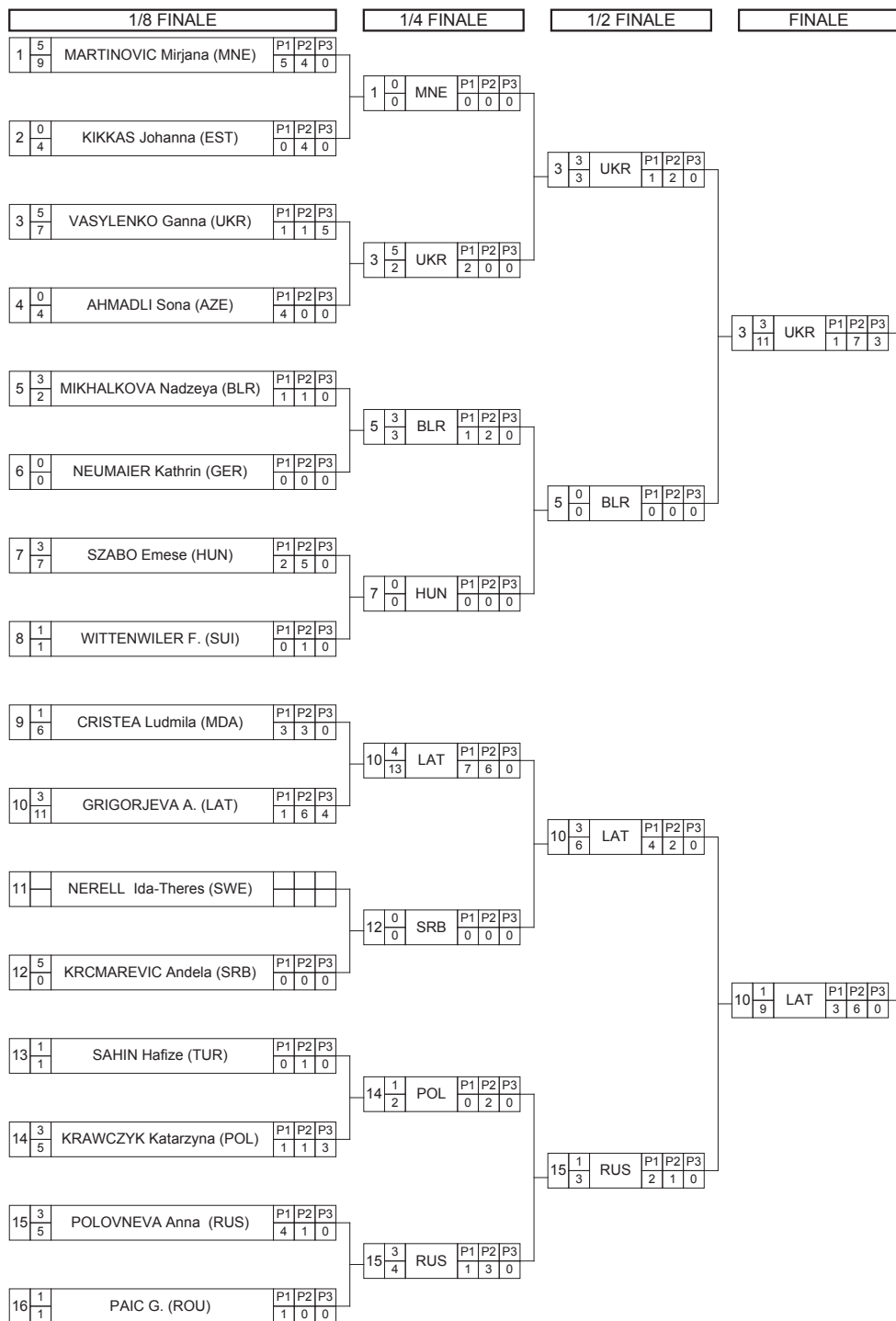

3 VASYLENKO Ganna (UKR)

Classement

Cl	Pays	Nom
1	UKR	VASYLENKO Ganna
2	LAT	GRIGORJEVA A.
3	AZE	AHMADLI Sona
3	MDA	CRISTEA Ludmila
5	BLR	MIKHALKOVA Nadzeya
5	RUS	POLOVNEVA Anna
7	MNE	MARTINOVIC Mirjana
8	SRB	KRCMAREVIC Andela
9	POL	KRAWCZYK Katarzyna
10	HUN	SZABO Emese
11	ROU	PAIC G.
11	TUR	SAHIN Hafize
13	SUI	WITTENWILER F.
14	EST	KIKKAS Johanna
15	SWE	NERELL Ida-Theres
16	GER	NEUMAIER Kathrin

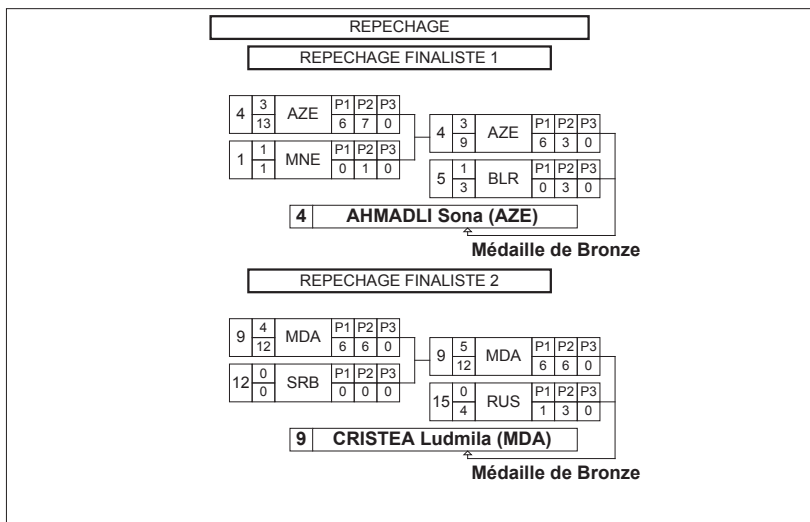

Classement**Senior European Championship 2012**

STYLE : FW 59 kg

**1 - Or / Gold**

VASYLENKO Ganna

2 - Argent / Silver

GRIGORJEVA Anastasija

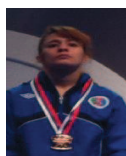
3 - Bronze

AHMADLI Sona

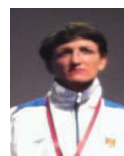

CRISTEA Ludmila

<i>Classement</i>	<i>Nom - Name</i>	<i>Pays - Country</i>
1	VASYLENKO Ganna	UKR
2	GRIGORJEVA A.	LAT
3	AHMADLI Sona	AZE
3	CRISTEA Ludmila	MDA
5	MIKHALKOVA Nadzeya	BLR
5	POLOVNEVA Anna	RUS
7	MARTINOVIC Mirjana	MNE
8	KRCMAREVIC Andela	SRB
9	KRAWCZYK Katarzyna	POL
10	SZABO Emese	HUN
11	PAIC G.	ROU
11	SAHIN Hafize	TUR
13	WITTENWILER F.	SUI
14	KIKKAS Johanna	EST
15	NERELL Ida-Theres	SWE
16	NEUMAIER Kathrin	GER



Feuille de compétition / Competition Sheet

Senior European Championship 2012



STYLE : FW 63 kg

QUALIFICATION			1/8 FINALE			1/4 FINALE			1/2 FINALE			FINALE		
1	HUCHOK Anastasiya (BLR)		1	1	BLR	1	1	BLR	3	1	POL	6	1	RUS
			2	2		2	0	GRE	4	4		1	1	
2	PAPAVASILEIOU A. (GRE)		2	3	GRE	3	3	POL	6	3	RUS	1	1	
			5	5		2	0		4	4		1	1	
3	MICHALIK M. (POL)		3	5	POL	3	3	POL	6	3	RUS	1	1	
			10	10		2	0		4	4		1	1	
4	TUBA Ana (SRB)		4	0	SRB	7	0	BUL	6	3	RUS	1	1	
			0	0		0	0		4	4		1	1	
5	MENDEZ MAYO M. (ESP)		5	0	ESP	7	0	BUL	6	3	RUS	1	1	
			0	0		0	0		4	4		1	1	
6	SMIRNOVA Natalia (RUS)		6	5	RUS	7	0	BUL	6	3	RUS	1	1	
			4	4		0	0		4	4		1	1	
7	VASEVA E. (BUL)		7	4	BUL	7	0	BUL	6	3	RUS	1	1	
			12	12		0	0		4	4		1	1	
8	SCALEN Sarlote (NOR)		8	0	NOR	7	0	BUL	6	3	RUS	1	1	
			0	0		0	0		4	4		1	1	
9	SPOUSTOVA Michala (CZE)		9	0	CZE	10	1	FRA	12	3	UKR	1	1	
			0	0		2	2		2	2		1	1	
10	PRIETO A. (FRA)		10	3	FRA	10	1	FRA	12	3	UKR	1	1	
			4	4		2	2		2	2		1	1	
11	MATTSSON M. (SWE)		11	1	SWE	12	3	UKR	12	3	UKR	1	1	
			1	1		4	4		2	2		1	1	
12	OSTAPCHUK Yuliya (UKR)		12	3	UKR	12	3	UKR	12	3	UKR	1	1	
			4	4		2	2		2	2		1	1	
13	CONNOLLY S. (GBR)	P1 P2 P3 0 0 0	14	0	GER	15	3	TUR	15	1	TUR	1	1	
			0	0		8	8		1	1		1	1	
14	ENGLICH HEES Y. (GER)	P1 P2 P3 7 4 0	14	0	GER	15	3	TUR	15	1	TUR	1	1	
			0	0		2	2		1	1		1	1	
15	YESILIRMAK E. (TUR)	P1 P2 P3 1 6 0	15	3	TUR	18	3	ITA	18	1	ITA	1	1	
			2	2		4	4		2	2		1	1	
16	RAFFLER Laura (AUT)	P1 P2 P3 0 0 0	18	3	ITA	18	1	ITA	18	1	ITA	1	1	
			4	4		2	2		2	2		1	1	
17	ZAMULA Olesya (AZE)	P1 P2 P3 0 1 0	18	3	ITA	18	1	ITA	18	1	ITA	1	1	
			4	4		2	2		2	2		1	1	
18	DIANA Maria (ITA)	P1 P2 P3 1 0 2	18	3	ITA	18	1	ITA	18	1	ITA	1	1	
			4	4		2	2		2	2		1	1	
19	PETROVA Irina (LAT)	P1 P2 P3 2 1 0	20	0	ROU	20	0	ROU	20	0	ROU	1	1	
			0	0		0	0		0	0		1	1	
20	OANCEA Beatrice (ROU)	P1 P2 P3 4 3 0	20	0	ROU	20	0	ROU	20	0	ROU	1	1	
			0	0		0	0		0	0		1	1	

12 OSTAPCHUK Yuliya (UKR)

Classement

Cl	Pays	Nom
1	UKR	OSTAPCHUK Yuliya
2	RUS	SMIRNOVA Natalia
3	POL	MICHALIK Monika Ewa
3	TUR	YESILIRMAK E.
5	BUL	VASEVA E.
5	SWE	MATTSSON M.
7	ITA	DIANA Maria
8	GER	ENGLICH HEES Y.
9	FRA	PRIETO A.
10	ROU	OANCEA Beatrice
11	GRE	PAPAVASILEIOU Agoro
12	LAT	PETROVA Irina
13	BLR	HUCHOK Anastasiya
14	AZE	ZAMULA Olesya
15	CZE	SPOUSTOVA Michala
16	AUT	RAFFLER Laura
17	ESP	MENDEZ MAYO M.
18	SRB	TUBA Ana
19	GBR	CONNOLLY S.
20	NOR	SCALEN Sarlote

REPECHAGE

REPECHAGE FINALISTE 1

5	0	ESP	P1 P2 P3 0 0 0	7	1	BUL	P1 P2 P3 3 1 0
7	5	BUL	P1 P2 P3 4 0 0	3	3	POL	P1 P2 P3 0 3 1
3 MICHALIK M. (POL)							

Médaille de Bronze

REPECHAGE FINALISTE 2

11	3	SWE	P1 P2 P3 1 2 0	11	0	SWE	P1 P2 P3 0 0 0
10	1	FRA	P1 P2 P3 0 1 0	15	3	TUR	P1 P2 P3 1 1 0
15 YESILIRMAK E. (TUR)							

Médaille de Bronze

Classement**Senior European Championship 2012**

STYLE : FW 63 kg

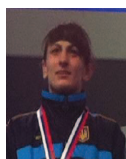
**1 - Or / Gold**

OSTAPCHUK Yuliya

2 - Argent / Silver

SMIRNOVA Natalia

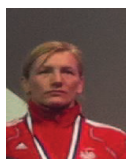
3 - Bronze

MICHALIK Monika Ewa

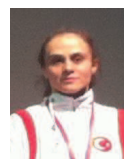

YESILIRMAK Elif Jale

<i>Classement</i>	<i>Nom - Name</i>	<i>Pays - Country</i>
1	OSTAPCHUK Yuliya	UKR
2	SMIRNOVA Natalia	RUS
3	MICHALIK Monika Ewa	POL
3	YESILIRMAK E.	TUR
5	MATTSSON M.	SWE
5	VASEVA E.	BUL
7	DIANA Maria	ITA
8	ENGLISH HEES Y.	GER
9	PRIETO A.	FRA
10	OANCEA Beatrice	ROU
11	PAPAVASILEIOU Agoro	GRE
12	PETROVA Irina	LAT
13	HUCHOK Anastasiya	BLR
14	ZAMULA Olesya	AZE
15	SPOUSTOVA Michala	CZE
16	RAFFLER Laura	AUT
17	MENDEZ MAYO M.	ESP
18	TUBA Ana	SRB
19	CONNOLLY S.	GBR
20	SCALEN Sarlote	NOR



Feuille de compétition / Competition Sheet

Senior European Championship 2012



STYLE : FW 67 kg

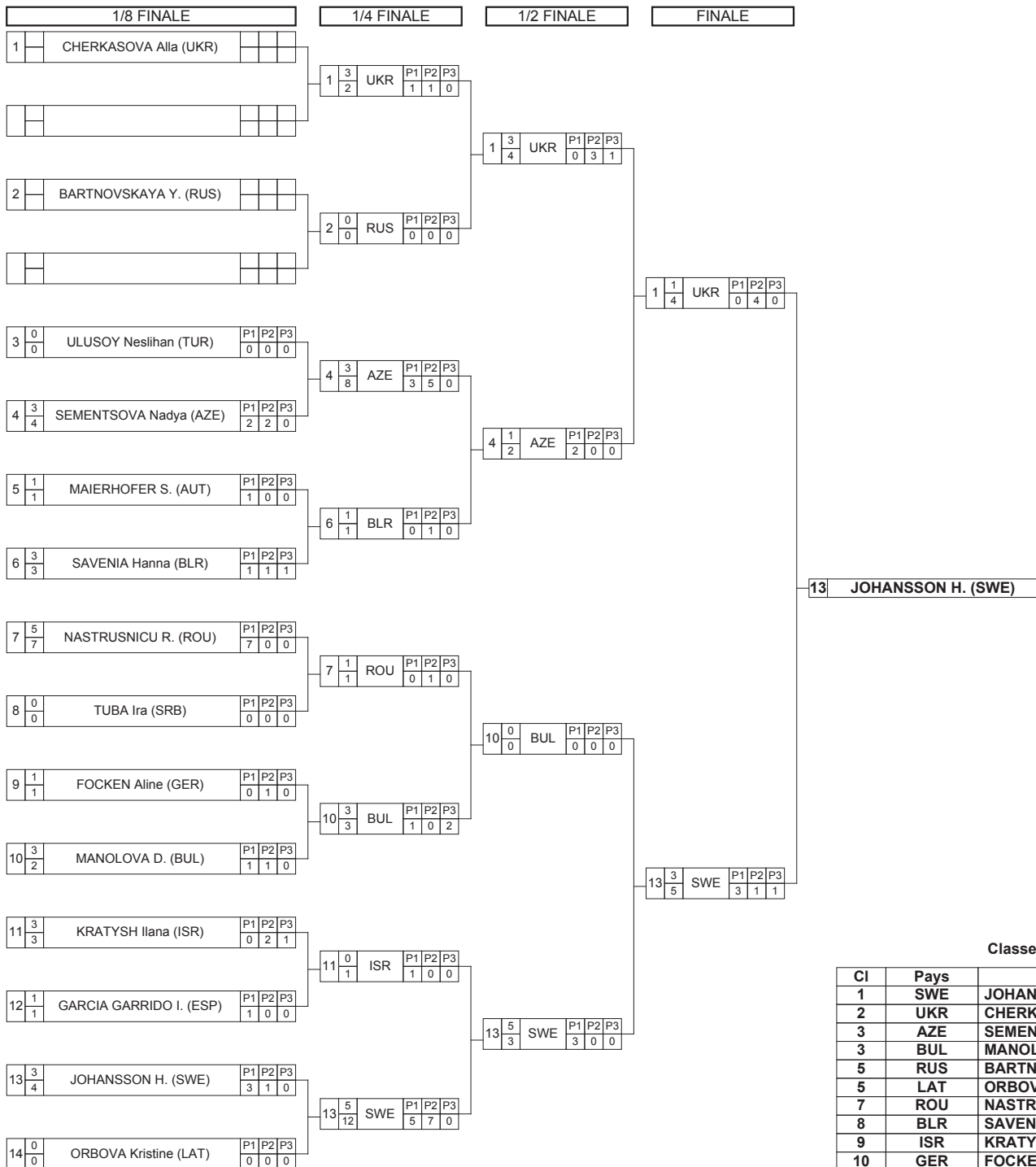

Classement

Cl	Pays	Nom
1	SWE	JOHANSSON H.
2	UKR	CHERKASOVA Alla
3	AZE	SEMENTSOVA Nadya
3	BUL	MANOLOVA D.
5	RUS	BARTNOVSKAYA Yuliya
5	LAT	ORBOVA Kristine
7	ROU	NASTRUSNICU R.
8	BLR	SAVENIA Hanna
9	ISR	KRATYSH Ilana
10	GER	FOCKEN Aline
11	ESP	GARCIA GARRIDO I.
11	AUT	MAIERHOFER S.
13	TUR	ULUSOY Neslihan
14	SRB	TUBA Ira

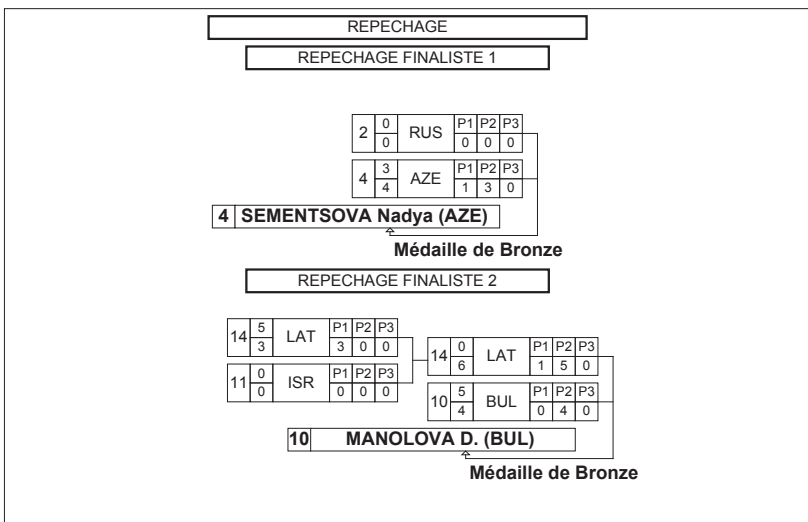

Classement**Senior European Championship 2012**

STYLE : FW 67 kg

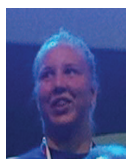
**1 - Or / Gold**

JOHANSSON Hanna Katarina

2 - Argent / Silver

CHERKASOVA Alla

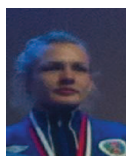
3 - Bronze

SEMENTSOVA Nadya MANOLOVA Dzhanan Filipova

<i>Classement</i>	<i>Nom - Name</i>	<i>Pays - Country</i>
1	JOHANSSON H.	SWE
2	CHERKASOVA Alla	UKR
3	SEMENTSOVA Nadya	AZE
3	MANOLOVA D.	BUL
5	BARTNOVSKAYA Yuliya	RUS
5	ORBOVA Kristine	LAT
7	NASTRUSNICU R.	ROU
8	SAVENIA Hanna	BLR
9	KRATYSH Ilana	ISR
10	FOCKEN Aline	GER
11	GARCIA GARRIDO I.	ESP
11	MAIERHOFER S.	AUT
13	ULUSOY Neslihan	TUR
14	TUBA Ira	SRB



Feuille de compétition / Competition Sheet

Senior European Championship 2012



STYLE : FW 72 kg

QUALIFICATION			1/8 FINALE			1/4 FINALE			1/2 FINALE			FINALE				
1	GASTL Marina (AUT)		1	5 7	AUT	P1 3	P2 4	P3 0	1	1 2	AUT	P1 2	P2 0	P3 0		
2	HUG Lisa (GER)		2	0 0	GER	P1 0	P2 0	P3 0	3	1 1	SWE	P1 0	P2 1	P3 0		
3	FRANSSON A. (SWE)		3	3 2	SWE	P1 1	P2 0	P3 1	3	3 5	SWE	P1 3	P2 2	P3 0		
4	GODO Kitti (HUN)		4	1 2	HUN	P1 0	P2 2	P3 0	5	5 4	UKR	P1 4	P2 0	P3 0		
5	BURMISTROVA K. (UKR)		5	5 4	UKR	P1 4	P2 0	P3 0	6	0 0	ARM	P1 0	P2 0	P3 0		
6	SHABOYAN Karine (ARM)		6	0 0	ARM	P1 0	P2 0	P3 0	7	5 8	RUS	P1 6	P2 2	P3 0		
7	VARABJOVA Natalia (RUS)		7	5 8	RUS	P1 6	P2 2	P3 0	7	1 1	RUS	P1 1	P2 0	P3 0		
8	HRISTOVA S. (BUL)		8	0 0	BUL	P1 0	P2 0	P3 0	9	3 11	NOR	P1 5	P2 6	P3 0		
9	ERLANDSEN M. (NOR)		9	3 11	NOR	P1 5	P2 6	P3 0	10	0 0	TUR	P1 0	P2 0	P3 0		
10	ADAR Yasemin (TUR)		10	0 0	TUR	P1 0	P2 0	P3 0	11	0 0	GBR	P1 0	P2 0	P3 0		
11	SPITERI C. (GBR)		11	0 0	GBR	P1 0	P2 0	P3 0	12	0 0	AZE	P1 0	P2 0	P3 0		
12	PALAMARCHUK N. (AZE)		12	5 10	AZE	P1 6	P2 4	P3 0	13	3 8	ROU	P1 5	P2 3	P3 0		
13	MUDRAG Elena Diana (ROU)	P1 5	P2 3	P3 0	13	0 0	ROU	P1 0	P2 0	P3 0	15	5 8	BLR	P1 4	P2 4	P3 0
14	VRYONI M. (GRE)	P1 1	P2 3	P3 0	15	5 8	BLR	P1 4	P2 4	P3 0	16	0 0	SRB	P1 0	P2 0	P3 0
15	MARZALIUK Vasilisa (BLR)	P1 7	P2 5	P3 0	16	0 0	SRB	P1 0	P2 0	P3 0	17	1 1	ITA	P1 1	P2 0	P3 0
16	TUBA Una Svetlana (SRB)	P1 0	P2 0	P3 0	17	1 1	ITA	P1 1	P2 0	P3 0	18	3 11	FRA	P1 0	P2 0	P3 0
17	CANEVA Dalma (ITA)	P1 1	P2 0	P3 0	18	3 11	FRA	P1 0	P2 0	P3 0	19	3 5	ESP	P1 0	P2 2	P3 3
18	VESCAN C. (FRA)	P1 4	P2 7	P3 0	19	3 5	ESP	P1 0	P2 2	P3 3	19	3 5	ESP	P1 0	P2 2	P3 3
19	UNDA GONZALEZ DE AUDICANA M. (ESP)	P1 4	P2 7	P3 0	19	3 5	ESP	P1 0	P2 2	P3 3						
20	MAE Epp (EST)	P1 0	P2 0	P3 0												

9 ERLANDSEN M. (NOR)

Classement

Cl	Pays	Nom
1	NOR	ERLANDSEN M.
2	UKR	BURMISTROVA K.
3	RUS	VARABJOVA Natalia
3	ESP	UNDA GONZALEZ DE AUDICANA M.
5	SWE	FRANSSON A.
5	AZE	PALAMARCHUK N.
7	BLR	MARZALIUK Vasilisa
8	AUT	GASTL Marina
9	FRA	VESCAN C.
10	ROU	MUDRAG Elena Diana
11	GRE	VRYONI Maria Louiza
12	HUN	GODO Kitti
13	ITA	CANEVA Dalma
14	TUR	ADAR Yasemin
15	EST	MAE Epp
16	GER	HUG Lisa
17	BUL	HRISTOVA S.
18	GBR	SPITERI C.
19	SRB	TUBA Una Svetlana
19	ARM	SHABOYAN Karine

REPECHAGE

REPECHAGE FINALISTE 1

6	0 0	ARM	P1 0	P2 0	P3 0	7	5 8	RUS	P1 5	P2 3	P3 0	3	0 0	SWE	P1 0	P2 0	P3 0
		7 VARABJOVA Natalia (RUS)															

Médaille de Bronze

REPECHAGE FINALISTE 2

10	0 4	TUR	P1 1	P2 3	P3 0	12	0 0	AZE	P1 0	P2 0	P3 0	19	3 3	ESP	P1 1	P2 2	P3 0
		UNDA GONZALEZ DE AUDICANA M. (ESP)															

Médaille de Bronze

Classement

Senior European Championship 2012

STYLE : FW 72 kg



1 - Or / Gold

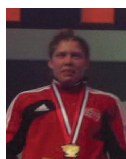

ERLANDSEN Maja Gunvor

2 - Argent / Silver

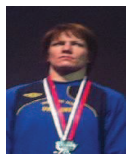

BURMISTROVA Kateryna

3 - Bronze

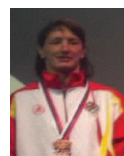
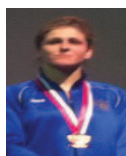

VARABJOVA Natalia UNDA GONZALEZ DE AUDICANA Maidir

Classement	Nom - Name	Pays - Country
1	ERLANDSEN M.	NOR
2	BURMISTROVA K.	UKR
3	VARABJOVA Natalia	RUS
3	UNDA GONZALEZ DE AUDICANA M.	ESP
5	PALAMARCHUK N.	AZE
5	FRANSSON A.	SWE
7	MARZALIUK Vasilisa	BLR
8	GASTL Marina	AUT
9	VESCAN C.	FRA
10	MUDRAG Elena Diana	ROU
11	VRIONI Maria Louiza	GRE
12	GODO Kitti	HUN
13	CANEVA Dalma	ITA
14	ADAR Yasemin	TUR
15	MAE Epp	EST
16	HUG Lisa	GER
17	HRISTOVA S.	BUL
18	SPITERI C.	GBR
19	TUBA Una Svetlana	SRB
19	SHABOYAN Karine	ARM

**Classement par équipe / Teams ranking****Senior European Championship 2012****STYLE FW**

Rang	Equipe	48 KG	51 KG	55 KG	59 KG	63 KG	67 KG	72 KG	TOTAL
1	UKR	10	9	10	10	10	9	9	67
2	RUS	8	8	8	6	9	6	8	53
3	SWE			9		6	10	6	31
4	AZE	3	6		8		8	6	31
5	POL	4	10	6	2	8			30
6	ROU	9		8		1	4	1	23
7	GER	8	8			3	1		20
8	NOR	6						10	16
9	LAT				9		6		15
10	BUL	1				6	8		15
11	TUR		6			8			14
12	BLR				6		3	4	13
13	MDA		1		8				9
14	HUN	6		2	1				9
15	ITA	2	3			4			9
16	ESP							8	8
17	FRA		2	1		2		2	7
18	GRE			6					6
19	FIN			4					4
20	MNE				4				4
21	NED		4						4
22	AUT							3	3
23	SRB				3				3
24	SUI			3					3
25	ISR						2		2
26	ARM								0
26	CZE								0
26	EST								0
26	GBR								0
26	LTU								0
26	POR								0
26	SVK								0

SENIOR EUROPEAN CHAMPIONSHIP - BELGRADE 2012



BELGRADE (SRB)

2012 - 03 - 06 - 2012 - 03- 12

Résultats - Results

Greco Roman





Raphael Marineti

President FILA

TzenoTzenov

President CEL

Kim Ik-Jong (UZB)

Technical delegate

Ruziev Akhro (KOR)

Technical delegate

IantchoKostandinov (BUL)

FILA Instructor

AyikAhmet (TUR)

Vice-President FILA

Stan Dziedic (USA)

Vice-President FILA

DrPelliconeMatteo (ITA)

Vice-President FILA

Michel Dusson (FRA)

General Secretary FILA

NamigAliyev (AZE)

FILA Bureau member

TheodorosHamakos (GRE)

FILA Bureau member

CsabaHegedus (HUN)

FILA Bureau member

NenadLalovic (SRB)

FILA Bureau member

Mikhail Mamiashvili (RUS)

FILA Bureau member

Rodica Maia Yaksi (TUR)

FILA Bureau member

ZeljkoTrajkovic

President Wrestling Federation of Serbia

Rajko Baltic

Director ECH – Belgrad 2012.



Liste des équipes / Teams List

Senior European Championship 2012

STYLE GR



Equipes - Teams

	ALBANIE	ALB
	ALLEMAGNE	GER
	ARMENIE	ARM
	AUTRICHE	AUT
	AZERBAIDJAN	AZE
	BELARUS	BLR
	BULGARIE	BUL
	CROATIE	CRO
	DANEMARK	DEN
	ESPAGNE	ESP
	ESTONIE	EST
	FINLANDE	FIN
	FRANCE	FRA
	GEORGIE	GEO
	GRANDE BRETAGNE	GBR
	GRECE	GRE
	HONGRIE	HUN
	ISRAEL	ISR
	ITALIE	ITA
	LETTONIE	LAT
	LITUANIE	LTU
	MOLDAVIE	MDA
	MONTÉNÉGRO	MNE
	NORVEGE	NOR
	POLOGNE	POL
	PORTUGAL	POR
	ROUMANIE	ROU
	RUSSIE	RUS
	SERBIA	SRB
	SLOVAQUIE	SVK
	SLOVENIE	SLO
	SUEDE	SWE
	SUISSE	SUI
	TCHEQUE REP.	CZE
	TURQUIE	TUR
	UKRAINE	UKR

Nombre d'équipes - Number of Teams

36





**Nombre d'engagés par équipe / Number of Entries By Team****Senior European Championship 2012**

STYLE GR

<i>Equipe - Teams</i>	<i>120 KG</i>	<i>55 KG</i>	<i>60 KG</i>	<i>66 KG</i>	<i>74 KG</i>	<i>84 KG</i>	<i>96 KG</i>	<i>TOTAL</i>
ALB					1	1		2
ARM	1		1	1	1	1	1	6
AUT				1	1	1		3
AZE	1	1	1	1	1	1	1	7
BLR	1	1	1	1	1	1	1	7
BUL	1	1	1	1	1	1	1	7
CRO	1	1	1	1	1	1	1	7
CZE				1	1	1	1	4
DEN				1	1	1		3
ESP			1			1		2
EST	1		1			1	1	4
FIN		1	1		1	1	1	5
FRA	1		1	1	1	1		5
GBR			1					1
GEO	1	1	1	1	1	1	1	7
GER	1	1	1	1	1	1	1	7
GRE	1	1	1	1	1	1	1	7
HUN	1	1		1	1	1	1	6
ISR		1		1	1		1	4
ITA	1	1	1	1	1	1	1	7
LAT	1			1	1	1		4
LTU	1		1	1	1	1	1	6
MDA		1	1	1	1	1	1	6
MNE	1					1		2
NOR		1		1	1	1		4
POL	1		1	1	1	1	1	6
POR			1	1				2
ROU	1	1	1	1	1	1	1	7
RUS	1	1	1	1	1	1	1	7
SLO					1			1
SRB	1	1	1	1	1	1	1	7
SUI			1	1	1	1		4

**Nombre d'engagés par équipe / Number of Entries By Team****Senior European Championship 2012**

STYLE GR

Equipe - Teams	120 KG	55 KG	60 KG	66 KG	74 KG	84 KG	96 KG	TOTAL
 SVK			1	1	1	1	1	5
 SWE	1	1	1	1	1	1	1	7
 TUR	1	1	1	1	1	1	1	7
 UKR	1	1	1	1	1	1	1	7

TOTAL	22	19	26	29	31	32	24	183
--------------	-----------	-----------	-----------	-----------	-----------	-----------	-----------	------------

Nombre de nations - Number of Countries **36**



Feuille de compétition / Competition Sheet

Senior European Championship 2012



STYLE : GR 55 kg

QUALIFICATION		1/8 FINALE	1/4 FINALE	1/2 FINALE	FINALE
1	HARABADZE Kemal (GEO)	1 1 3	GEO P1 P2 P3 0 3 0		
2	TAZHIEU Elbek (BLR)	2 3 8	BLR P1 P2 P3 3 5 0		
3	RONNINGEN A. (NOR)	3 0 0	NOR P1 P2 P3 0 0 0		
4	UCUNCU Fatih (TUR)	4 3 4	TUR P1 P2 P3 1 3 0	4 1 1	TUR P1 P2 P3 0 1 0
5	KHARKO Dmytro (UKR)	5 3 4	UKR P1 P2 P3 2 2 0		
6	KAKI Ville Ilmari (FIN)	6 0 0	FIN P1 P2 P3 0 0 0		
7	AMOYAN Roman (ARM)	7 0 3	ARM P1 P2 P3 3 0 0		
8	ALIYEV Elchin (AZE)	8 5 5	AZE P1 P2 P3 0 3 2	8 3 2	AZE P1 P2 P3 1 1 0
9	FAGERLUND B. (SWE)	9 0 0	SWE P1 P2 P3 0 0 0		
10	SEMOV Mingiyar (RUS)	10 3 3	RUS P1 P2 P3 2 1 0		
11	MUNTEANU Virgil (ROU)	11 3 3	ROU P1 P2 P3 2 1 0		
12	SCHERF Dustin (GER)	12 0 0	GER P1 P2 P3 0 0 0		
13	LIZATOVIC Ivan (CRO)	13 1 1	CRO P1 P2 P3 1 0 0		
14	TSARYUK Vladimir (ISR)	14 0 0	ISR P1 P2 P3 0 0 0		
15	CIOBANU Victor (MDA)	15 3 11	MDA P1 P2 P3 6 5 0		
16	KARATHANASSIS L. (GRE)	16 0 0	GRE P1 P2 P3 0 0 0		
17	MODOS Peter (HUN)	17 4 13	HUN P1 P2 P3 6 7 0		
18	GAZDAG Kristian (SRB)	18 0 0	SRB P1 P2 P3 0 0 0		
19	KOSTADINOV A. (BUL)	19 3 7	BUL P1 P2 P3 5 2 0		
20	MANEA Federico (ITA)	20 0 0	ITA P1 P2 P3 0 0 0		

8 ALIYEV Elchin (AZE)

Classement

Cl	Pays	Nom
1	AZE	ALIYEV Elchin
2	HUN	MODOS Peter
3	TUR	UCUNCU Fatih
3	BUL	KOSTADINOV A.
5	UKR	KHARKO Dmytro
5	RUS	SEMOV Mingiyar
7	MDA	CIOBANU Victor
8	CRO	LIZATOVIC Ivan
9	BLR	TAZHIEU Elbek
10	ROU	MUNTEANU Virgil
11	GEO	HARABADZE Kemal
12	SRB	GAZDAG Kristian
13	ISR	TSARYUK Vladimir
14	SWE	FAGERLUND B.
14	GER	SCHERF Dustin
16	NOR	RONNINGEN A.
16	FIN	KAKI Ville Ilmari
18	ITA	MANEA Federico
19	GRE	KARATHANASSIS L.

REPECHAGE

REPECHAGE FINALISTE 1

7 0 0	ARM P1 P2 P3 0 0 0	5 0 0	UKR P1 P2 P3 0 0 0	4 3 8	TUR P1 P2 P3 3 5 0
4 UCUNCU Fatih (TUR)					

Médaille de Bronze

REPECHAGE FINALISTE 2

18 1 1	SRB P1 P2 P3 0 1 0	19 3 3	BUL P1 P2 P3 0 1 2	19 3 8	BUL P1 P2 P3 1 3 4
19 3 5	BUL P1 P2 P3 1 4 0	15 1 3	MDA P1 P2 P3 3 0 0	10 1 6	RUS P1 P2 P3 6 0 0
19 KOSTADINOV A. (BUL)					

Médaille de Bronze



Classement

Senior European Championship 2012



STYLE : GR 55 kg

1 - Or / Gold

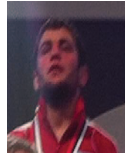

ALIYEV Elchin

2 - Argent / Silver

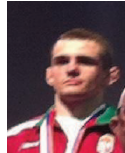

MODOS Peter

3 - Bronze

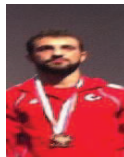

UCUNCU Fatih

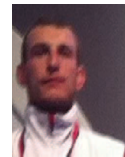

KOSTADINOV Aleksandar Stoyanov

Classement	Nom - Name	Pays - Country
1	ALIYEV Elchin	AZE
2	MODOS Peter	HUN
3	UCUNCU Fatih	TUR
3	KOSTADINOV A.	BUL
5	KHARKO Dmytro	UKR
5	SEMENOV Mingyan	RUS
7	CIOBANU Victor	MDA
8	LIZATOVIC Ivan	CRO
9	TAZHIEU Elbek	BLR
10	MUNTEANU Virgil	ROU
11	HARABADZE Kemal	GEO
12	GAZDAG Kristian	SRB
13	TSARYUK Vladimir	ISR
14	FAGERLUND B.	SWE
14	SCHERF Dustin	GER
16	RONNINGEN A.	NOR
16	KAKI Ville Ilmari	FIN
18	MANEA Federico	ITA
19	KARATHANASSIS L.	GRE



Feuille de compétition / Competition Sheet

Senior European Championship 2012



STYLE : GR 60 kg

QUALIFICATION		1/8 FINALE		1/4 FINALE		1/2 FINALE		FINALE	
1	DAGYS Ramunas (LTU)	1	3/2 LTU	1	0/2 LTU	3	0/0 BLR	5	3/3 SVK
2	BAGHUMYAN AGHAZARYAN A. (ESP)	2	1/3 ESP	2	1/2 SRB	5	3/6 SVK	5	3/3 SVK
3	KAZHARSKI Maksim (BLR)	3	3/2 BLR	3	5/5 BLR	8	1/2 SRB	16	1/1 AZE
4	MACRI Vincenzo (ITA)	4	0/0 ITA	4	0/0 SUI	13	0/0 FRA	16	3/4 AZE
5	LEVAI Istvan (SVK)	5	3/2 SVK	5	3/10 SVK	16	3/4 AZE	22	0/0 BUL
6	SOKOL Tonimir (CRO)	6	0/0 CRO	6	0/0 SWE	17	1/1 ARM	22	3/6 BUL
7	ALMEIDA Manuel (POR)	7	0/0 POR	7	0/0 SWE	19	1/1 RUS	23	0/2 GEO
8	STEFANEK Davor (SRB)	8	3/4 SRB	8	1/2 SRB	22	3/7 BUL	23	0/2 GEO
9	STADELMANN Patrick (SUI)	9	3/7 SUI	9	0/0 SUI	22	3/6 BUL	25	3/4 EST
10	ISLAMOV Donior (MDA)	10	0/0 MDA	10	0/0 SWE	22	3/6 BUL	26	0/0 GRE
11	BAST Christoph (GER)	11	0/1 GER	11	0/0 SWE	22	3/6 BUL		
12	LINDQVIST STOLT R. (SWE)	12	5/8 SWE	12	0/0 SWE	22	3/6 BUL		
13	BELMADANI Tarik (FRA)	13	3/4 FRA	13	3/3 FRA	22	3/6 BUL		
14	ISRAFILOV Ruslan (UKR)	14	0/0 UKR	14	3/3 FRA	22	3/6 BUL		
15	UIMONEN E. (FIN)	15	0/0 FIN	15	3/2 AZE	22	3/6 BUL		
16	MAMMADOV Kamran (AZE)	16	3/4 AZE	16	3/2 AZE	22	3/6 BUL		
17	MKRTCHYAN Artur (ARM)	17	3/5 ARM	17	3/4 AZE	22	3/6 BUL		
18	BARSEGJAN Edward (POL)	18	0/0 POL	18	1/1 ARM	22	3/6 BUL		
19	ABDULLIN Arslan (RUS)	19	3/3 RUS	19	1/1 ARM	22	3/6 BUL		
20	SUCU Soner (TUR)	20	1/1 TUR	20	1/1 RUS	22	3/6 BUL		
21	DIACONU E. (ROU)	21	0/0 ROU	21	1/1 RUS	22	3/6 BUL		
22	ANGELOV I. (BUL)	22	3/2 BUL	22	3/3 BUL	22	3/6 BUL		
23	CHOCHUA Irakli (GEO)	23	3/4 GEO	23	3/6 GEO	22	3/6 BUL		
24	BOSSON T. (GBR)	24	0/0 GBR	24	0/0 GEO	22	3/6 BUL		
25	ZEINALOV Anar (EST)	25	3/4 EST	25	0/0 EST	22	3/6 BUL		
26	MATIAS Vladimiro (GRE)	26	0/0 GRE	26	0/0 EST	22	3/6 BUL		

5 LEVAI Istvan (SVK)

Classement

Cl	Pays	Nom
1	SVK	LEVAI Istvan
2	BUL	ANGELOV I.
3	SRB	STEFANEK Davor
3	RUS	ABDULLIN Arslan
5	BLR	KAZHARSKI Maksim
5	AZE	MAMMADOV Kamran
7	GEO	CHOCHUA Irakli
8	FRA	BELMADANI Tarik
9	SWE	LINDQVIST STOLT R.
10	ARM	MKRTCHYAN Artur
11	SUI	STADELMANN Patrick
12	EST	ZEINALOV Anar
13	LTU	DAGYS Ramunas
14	ESP	BAGHUMYAN AGHAZARYAN A.
15	TUR	SUCU Soner
16	CRO	SOKOL Tonimir
17	ROU	DIACONU E.
18	GER	BAST Christoph
19	ITA	MACRI Vincenzo
20	GBR	BOSSON T.
20	GRE	MATIAS Vladimiro
20	FIN	UIMONEN E.
20	UKR	ISRAFILOV Ruslan
24	POR	ALMEIDA Manuel
24	POL	BARSEGJAN Edward
26	MDA	ISLAMOV Donior

REPECHAGE

REPECHAGE FINALISTE 1

6	1/1 CRO	8	4/3 SRB
8	3/2 SRB	3	1/2 BLR
8 STEFANEK Davor (SRB)			

Médaille de Bronze

REPECHAGE FINALISTE 2

21	0/1 ROU	19	3/6 RUS
19	3/4 RUS	23	1/1 GEO
19 ABDULLIN Arslan (RUS)			

Médaille de Bronze

Classement

Senior European Championship 2012

STYLE : GR 60 kg



1 - Or / Gold

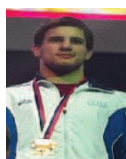

LEVAI Istvan

2 - Argent / Silver

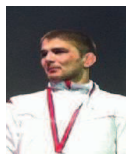

ANGELOV Ivo Serafimov

3 - Bronze

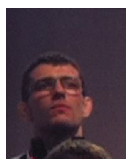

STEFANEK Davor



ABDULLIN Arslan

Classement	Nom - Name	Pays - Country
1	LEVAI Istvan	SVK
2	ANGELOV I.	BUL
3	STEFANEK Davor	SRB
3	ABDULLIN Arslan	RUS
5	KAZHARSKI Maksim	BLR
5	MAMMADOV Kamran	AZE
7	CHOCHUA Irakli	GEO
8	BELMADANI Tarik	FRA
9	LINDQVIST STOLT R.	SWE
10	MKRTCHYAN Artur	ARM
11	STADELMANN Patrick	SUI
12	ZEINALOV Anar	EST
13	DAGYS Ramunas	LTU
14	BAGHUMYAN AGHAZARYAN A.	ESP
15	SUCU Soner	TUR
16	SOKOL Tonimir	CRO
17	DIACONU E.	ROU
18	BAST Christoph	GER
19	MACRI Vincenzo	ITA
20	ISRAFILOV Ruslan	UKR
20	UIMONEN E.	FIN
20	MATIAS Vladimiro	GRE
20	BOSSON T.	GBR
24	ALMEIDA Manuel	POR
24	BARSEGJAN Edward	POL
26	ISLAMOVS Donior	MDA



Feuille de compétition / Competition Sheet

Senior European Championship 2012



STYLE : GR 66 kg

QUALIFICATION					1/8 FINALE			1/4 FINALE			1/2 FINALE			FINALE		
1					1	0	DEN	P1	P2	P3						
						0		0	0	0						
2					2	3	ISR	P1	P2	P3						
						5		3	2	0						
3					3	0	GRE	P1	P2	P3						
						0		0	0	0						
4	0				5	3	SRB	P1	P2	P3						
	0					5		1	4	0						
5	3				6	3	POR	P1	P2	P3						
	5					4		2	2	0						
6	3				8	0	CZE	P1	P2	P3						
	3					0		0	0	0						
7	1				10	5	GER	P1	P2	P3						
	1					7		3	4	0						
8	3				10	3	GER	P1	P2	P3						
	3					8		0	0	0						
9	1				10	3	GER	P1	P2	P3						
	1					3		1	2	0						
10	3				10	3	GER	P1	P2	P3						
	9					3		1	2	0						
11	0				12	0	SWE	P1	P2	P3						
	0					2		2	0	0						
12	3				14	3	ROU	P1	P2	P3						
	4					3		0	1	2						
13	0				14	3	ROU	P1	P2	P3						
	0					5		1	0	4						
14	3				16	1	BUL	P1	P2	P3						
	3					1		1	0	0						
15	1				19	3	RUS	P1	P2	P3						
	1					3		0	2	1						
16	3				19	1	RUS	P1	P2	P3						
	2					3		0	2	1						
17	1				20	1	FRA	P1	P2	P3						
	1					4		4	0	0						
18	0				23	3	CRO	P1	P2	P3						
	0					5		2	0	3						
19	3				23	0	CRO	P1	P2	P3						
	4					0		0	0	0						
20	3				24	1	TUR	P1	P2	P3						
	5					1		0	1	0						
21	0				26	3	BLR	P1	P2	P3						
	0					4		3	1	0						
22	1				26	3	BLR	P1	P2	P3						
	2					4		1	3	0						
23	3				29	1	ARM	P1	P2	P3						
	3					1		1	0	0						
24	3															
	2															
25	0															
	0															
26	3															
	4															
27	1															
	1															
28	1															
	2															
29	3															
	4															

10 STABLER Frank (GER)

Classement

Cl	Pays	Nom
1	GER	STABLER Frank
2	ROU	CARPEN Georgian
3	SRB	MAKSIMOVIC A.
3	RUS	ALBIEV Islam-Beka
5	BLR	KARDASH Yaraslau
5	POR	DA SILVA PASSOS H.
7	BUL	TODOROV E.
8	CRO	ETLINGER Dominik
9	FRA	MARGARYAN Artak
10	ISR	VECHSHEV Yuri
11	ARM	JULFALAKYAN Aram
12	TUR	AYVAZOGLU Refik
13	CZE	DUBSKY Filip
14	MDA	LUCHITA Ion
15	GEO	LASHKHI Revaz
16	LTU	VENCKAITIS Edgaras
17	HUN	KORPASI Balint
18	SVK	LEVAI Attila
19	ITA	CORRIGA Tiziano
19	AZE	RAHIMOV Vitaliy
21	UKR	VARDANYAN Armen
22	SUI	STREBEL Pascal
23	NOR	THOMMESEN M.
23	AUT	PUFFER Benedikt
25	DEN	BJERREHUUS F.
25	POL	MELKUMOV POGOSIAN E.
25	GRE	APOSTOLOU Christos
25	LAT	MIRONOV Sergejs
Disq.	SWE	GUNTHER Ove Mathias

REPECHAGE

REPECHAGE FINALISTE 1

11	0	LAT	P1	P2	P3	12	3	SWE	P1	P2	P3
	0		0	0	0		4		0	1	3
12	3	SWE	P1	P2	P3	12	3	SWE	P1	P2	P3
	8		2	6	0		8		3	3	2
						6	1	POR	P1	P2	P3
							2		1	0	1

12 GUNTHER O. (SWE)

Médaille de Bronze

REPECHAGE FINALISTE 2

15	1	MDA	P1	P2	P3	16	0	BUL	P1	P2	P3
	2		2	0	0		0		0	0	0
16	3	BUL	P1	P2	P3	19	3	RUS	P1	P2	P3
	5		0	3	2		4		1	3	0
						26	1	BLR	P1	P2	P3
							1		0	1	0

19 ALBIEV Islam-Beka (RUS)

Médaille de Bronze



Classement

Senior European Championship 2012

STYLE : GR 66 kg



1 - Or / Gold

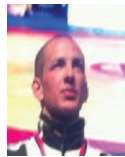

STABLER Frank

2 - Argent / Silver

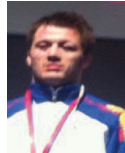

CARPEN Georgian

3 - Bronze

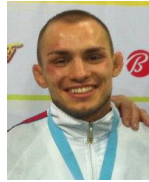

MAKSIMOVIC Aleksandar

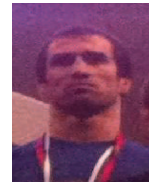

ALBIEV Islam-Beka

Classement	Nom - Name	Pays - Country
1	STABLER Frank	GER
2	CARPEN Georgian	ROU
3	MAKSIMOVIC A.	SRB
3	ALBIEV Islam-Beka	RUS
5	KARDASH Yaraslau	BLR
5	DA SILVA PASSOS H.	POR
7	TODOROV E.	BUL
8	ETLINGER Dominik	CRO
9	MARGARYAN Artak	FRA
10	VECHSHEV Yuri	ISR
11	JULFALAKYAN Aram	ARM
12	AYVAZOGLU Refik	TUR
13	DUBSKY Filip	CZE
14	LUCHITA Ion	MDA
15	LASHKHI Revaz	GEO
16	VENCKAITIS Edgaras	LTU
17	KORPASI Balint	HUN
18	LEVAI Attila	SVK
19	CORRIGA Tiziano	ITA
19	RAHIMOV Vitaliy	AZE
21	VARDANYAN Armen	UKR
22	THOMMESEN M.	NOR
23	STREBEL Pascal	SUI
23	PUFFER Benedikt	AUT
25	BJERREHUUS F.	DEN
25	MELKUMOV POGOSIAN E.	POL
25	APOSTOLOU Christos	GRE
25	MIRONOVS Sergejs	LAT
Disqualified	GUNTHER Ove Mathias	SWE



Feuille de compétition / Competition Sheet

Senior European Championship 2012



STYLE : GR 74 kg

QUALIFICATION				1/8 FINALE				1/4 FINALE				1/2 FINALE				FINALE									
1		MARCHL Florian (AUT)						1	0	AUT	P1	P2	P3												
2	3	TSKHADAIA Manuchar (GEO)	P1	P2	P3			2	5	GEO	P1	P2	P3					2	3	GEO	P1	P2	P3		
3	0	JANICKE Fabian (GER)	P1	P2	P3			3	10	GEO	P1	P2	P3					3	3	GEO	P1	P2	P3		
4	1	VISNAKOV S. (LAT)	P1	P2	P3			4	3	FRA	P1	P2	P3					4	3	GEO	P1	P2	P3		
5	3	GUENOT C. (FRA)	P1	P2	P3			5	4	FRA	P1	P2	P3					5	0	FRA	P1	P2	P3		
6	0	SCARAMUZZI Saverio (ITA)	P1	P2	P3			6	0	CZE	P1	P2	P3					6	0	FRA	P1	P2	P3		
7	5	NOVAK Petr (CZE)	P1	P2	P3			7	0	CZE	P1	P2	P3					7	0	FRA	P1	P2	P3		
8	1	BULATOVIC Goran (SRB)	P1	P2	P3			8	2	POL	P1	P2	P3					8	0	FRA	P1	P2	P3		
9	3	KULYNYCZ A. (POL)	P1	P2	P3			9	3	POL	P1	P2	P3					9	0	POL	P1	P2	P3		
10	1	SZABO Martin (HUN)	P1	P2	P3			10	1	ROU	P1	P2	P3					10	0	POL	P1	P2	P3		
11	3	PUSCASU Ionel (ROU)	P1	P2	P3			11	6	ROU	P1	P2	P3					11	1	ROU	P1	P2	P3		
12	5	KAZAKEVIC A. (LTU)	P1	P2	P3			12	3	LTU	P1	P2	P3					12	0	LTU	P1	P2	P3		
13	0	SUOMINEN V. (FIN)	P1	P2	P3			13	2	LTU	P1	P2	P3					13	0	LTU	P1	P2	P3		
14	5	STARCEVIC Bozo (CRO)	P1	P2	P3			14	1	CRO	P1	P2	P3					14	3	LTU	P1	P2	P3		
15	0	TRIANAFYLLIDIS I. (GRE)	P1	P2	P3			15	1	CRO	P1	P2	P3					15	3	LTU	P1	P2	P3		
16	3	TJORSTAD R. (NOR)	P1	P2	P3			16	0	NOR	P1	P2	P3					16	0	CRO	P1	P2	P3		
17	0	EKSTROM C. (DEN)	P1	P2	P3			17	0	NOR	P1	P2	P3					17	0	NOR	P1	P2	P3		
18	3	TUFENK Seref (TUR)	P1	P2	P3			18	3	TUR	P1	P2	P3					18	1	TUR	P1	P2	P3		
19	0	JAKUS Vojtech (SVK)	P1	P2	P3			19	4	TUR	P1	P2	P3					19	5	TUR	P1	P2	P3		
20	3	JULFALAKYAN Arsen (ARM)	P1	P2	P3			20	1	ARM	P1	P2	P3					20	3	TUR	P1	P2	P3		
21	0	BOSSERT Jonas (SUI)	P1	P2	P3			21	2	ARM	P1	P2	P3					21	0	ARM	P1	P2	P3		
22	0	NDOKA Meraldo (ALB)	P1	P2	P3			22	3	RUS	P1	P2	P3					22	0	ARM	P1	P2	P3		
23	3	VLASOV Roman (RUS)	P1	P2	P3			23	2	RUS	P1	P2	P3					23	3	RUS	P1	P2	P3		
24	1	PALENSKI Valery (BLR)	P1	P2	P3			24	1	ISR	P1	P2	P3					24	0	RUS	P1	P2	P3		
25	3	SHAFRAN Ilya (ISR)	P1	P2	P3			25	0	ISR	P1	P2	P3					25	0	ISR	P1	P2	P3		
26	1	BESLEAGA Igor (MDA)	P1	P2	P3			26	0	AZE	P1	P2	P3					26	0	ISR	P1	P2	P3		
27	3	MURSALIYEV Elvin (AZE)	P1	P2	P3			27	2	AZE	P1	P2	P3					27	0	AZE	P1	P2	P3		
28	0	KUHAR Jure (SLO)	P1	P2	P3			28	1	SWE	P1	P2	P3					28	0	AZE	P1	P2	P3		
29	3	ROSENGREN R. (SWE)	P1	P2	P3			29	2	SWE	P1	P2	P3					29	0	SWE	P1	P2	P3		
30	3	PYSHKOV Dmytro (UKR)	P1	P2	P3			30	3	UKR	P1	P2	P3					30	0	SWE	P1	P2	P3		
31	1	GEORGIEV I. (BUL)	P1	P2	P3			31	8	UKR	P1	P2	P3					31	3	UKR	P1	P2	P3		

23 VLASOV Roman (RUS)

Classement

Cl	Pays	Nom
1	RUS	VLASOV Roman
2	GEO	TSKHADAIA Manuchar
3	LTU	KAZAKEVIC Aleksandr
3	ARM	JULFALAKYAN Arsen
5	FRA	GUENOT C.
5	UKR	PYSHKOV Dmytro
7	TUR	TUFENK Seref
8	CRO	STARCEVIC Bozo
9	POL	KULYNYCZ A.
10	AZE	MURSALIYEV Elvin
11	CZE	NOVAK Petr
12	ROU	PUSCASU Ionel
13	SWE	ROSENGREN R.
14	AUT	MARCHL Florian
15	NOR	TJORSTAD Rasmus Nes
16	ISR	SHAFRAN Ilya
17	LAT	VISNAKOV S.
18	SRB	BULATOVIC Goran
19	BLR	PALENSKI Valery
20	BUL	GEORGIEV I.
20	MDA	BESLEAGA Igor
22	HUN	SZABO Martin
23	GRE	TRIANAFYLLIDIS I.
24	FIN	SUOMINEN V.
25	ITA	SCARAMUZZI Saverio
26	SLO	KUHAR Jure
26	SUI	BOSSERT Jonas
28	DEN	EKSTROM C.
28	SVK	JAKUS Vojtech
30	GER	JANICKE Fabian
31	ALB	NDOKA Meraldo

REPECHAGE

REPECHAGE FINALISTE 1

3	0	GER	P1	P2	P3			1	0	AUT	P1	P2	P3			5	1	FRA	P1	P2	P3		
1	3	AUT	P1	P2	P3			5	3	FRA	P1	P2	P3			12	3	LTU	P1	P2	P3		

12 KAZAKEVIC A. (LTU)

Médaille de Bronze

REPECHAGE FINALISTE 2

22	0	ALB	P1	P2	P3			20	3	ARM	P1	P2	P3			20	3	ARM	P1	P2	P3		
20	3	ARM	P1	P2	P3			18	0	TUR	P1	P2	P3			30	1	UKR	P1	P2	P3		

20 JULFALAKYAN Arsen (ARM)

Médaille de Bronze



Classement

Senior European Championship 2012



STYLE : GR 74 kg

1 - Or / Gold

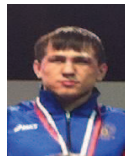

VLASOV Roman

2 - Argent / Silver



TSKHADAIA Manuchar

3 - Bronze



KAZAKEVIC Aleksandr

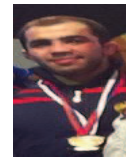

JULFALAKYAN Arsen

Classement	Nom - Name	Pays - Country
1	VLASOV Roman	RUS
2	TSKHADAIA Manuchar	GEO
3	KAZAKEVIC Aleksandr	LTU
3	JULFALAKYAN Arsen	ARM
5	GUENOT C.	FRA
5	PYSHKOV Dmytro	UKR
7	TUFENK Seref	TUR
8	STARCEVIC Bozo	CRO
9	KULYNYCZ A.	POL
10	MURSALIYEV Elvin	AZE
11	NOVAK Petr	CZE
12	PUSCASU Ionel	ROU
13	ROSENGREN R.	SWE
14	MARCHL Florian	AUT
15	TJORSTAD Rasmus Nes	NOR
16	SHAFRAN Ilya	ISR
17	VISNAKOV S. A.	LAT
18	BULATOVIC Goran	SRB
19	PALENSKI Valery	BLR
20	GEORGIEV I.	BUL
20	BESLEAGA Igor	MDA
22	SZABO Martin	HUN
23	TRIANAFYLLIDIS I.	GRE
24	SUOMINEN V.	FIN
25	SCARAMUZZI Saverio	ITA
26	KUHAR Jure	SLO
26	BOSSERT Jonas	SUI
28	EKSTROM C.	DEN
28	JAKUS Vojtech	SVK
30	JANICKE Fabian	GER
31	NDOKA Meraldo	ALB



Feuille de compétition / Competition Sheet

Senior European Championship 2012



STYLE : GR 84 kg

1/16 Finale			1/8 FINALE			1/4 FINALE			1/2 FINALE			FINALE			
1	3/4	MINGUZZI Andrea (ITA)	P1 P2 P3 1 3 0	1	3/2	ITA	P1 P2 P3 1 1 0	1	0/0	ITA	P1 P2 P3 0 0 0	8	3/3	POL	P1 P2 P3 0 1 2
2	0/0	ISAKSEN J. (NOR)	P1 P2 P3 0 0 0	4	0/0	SVK	P1 P2 P3 0 0 0	8	5/6	POL	P1 P2 P3 6 0 0	8	0/0	POL	P1 P2 P3 0 0 0
3	1/2	HRUSTANOVIC Amer (AUT)	P1 P2 P3 1 1 0	6	0/0	SWE	P1 P2 P3 0 0 0	9	3/2	LTU	P1 P2 P3 0 1 1	9	1/3	LTU	P1 P2 P3 3 0 0
4	3/3	MIHALIK Marian (SVK)	P1 P2 P3 2 0 1	8	3/3	POL	P1 P2 P3 1 2 0	15	1/3	AZE	P1 P2 P3 1 0 2	22	3/3	BUL	P1 P2 P3 2 1 0
5	1/3	AZISIRS Ramsin (GER)	P1 P2 P3 2 1 0	9	3/4	LTU	P1 P2 P3 3 1 0	20	0/3	GEO	P1 P2 P3 0 3 0	22	3/3	BUL	P1 P2 P3 1 2 0
6	3/3	PETTERSSON J. (SWE)	P1 P2 P3 0 1 2	12	0/0	SUI	P1 P2 P3 0 0 0	22	3/2	BUL	P1 P2 P3 1 1 0	28	0/0	EST	P1 P2 P3 0 0 0
7	0/1	BELENIUK Zhan (UKR)	P1 P2 P3 0 1 0	14	0/1	MDA	P1 P2 P3 0 1 0	23	0/0	HUN	P1 P2 P3 0 0 0	29	0/0	TUR	P1 P2 P3 0 0 0
8	5/4	JANIKOWSKI Damian (POL)	P1 P2 P3 1 0 3	15	3/3	AZE	P1 P2 P3 1 2 0	26	0/0	ARM	P1 P2 P3 0 0 0	31	3/2	CRO	P1 P2 P3 0 1 1
9	3/7	ADOMAITIS Laimutis (LTU)	P1 P2 P3 3 4 0	17	1/3	CZE	P1 P2 P3 0 3 0	28	3/3	EST	P1 P2 P3 1 2 0	31	1/1	CRO	P1 P2 P3 1 0 0
10	0/0	BALO Petar (SRB)	P1 P2 P3 0 0 0	20	3/6	GEO	P1 P2 P3 3 3 0	29	3/2	TUR	P1 P2 P3 0 1 1	32	1/1	BLR	P1 P2 P3 1 0 0
11	1/2	TAMAS Attila Gheza (ROU)	P1 P2 P3 2 0 0	22	3/3	BUL	P1 P2 P3 2 1 0	29	0/0	TUR	P1 P2 P3 0 0 0				
12	3/8	SUPPIGER Thomas (SUI)	P1 P2 P3 1 1 6	23	0/0	HUN	P1 P2 P3 0 0 0	29	0/0	TUR	P1 P2 P3 0 0 0				
13	0/0	ROMANOVSKIS Z. (LAT)	P1 P2 P3 0 0 0	26	0/0	ARM	P1 P2 P3 0 0 0	29	0/0	TUR	P1 P2 P3 0 0 0				
14	3/3	ZGHEREA Serghei (MDA)	P1 P2 P3 1 2 0	28	3/3	EST	P1 P2 P3 1 2 0	29	0/0	TUR	P1 P2 P3 0 0 0				
15	3/3	TAHMASEBI S. (AZE)	P1 P2 P3 2 1 0	28	3/3	EST	P1 P2 P3 1 2 0	29	0/0	TUR	P1 P2 P3 0 0 0				
16	0/0	MISHIN Aleksey (RUS)	P1 P2 P3 0 0 0	29	3/2	TUR	P1 P2 P3 0 1 1	29	0/0	TUR	P1 P2 P3 0 0 0				
17	3/7	OMAROV Artur (CZE)	P1 P2 P3 1 2 4	31	1/1	CRO	P1 P2 P3 1 0 0	29	0/0	TUR	P1 P2 P3 0 0 0				
18	1/5	ERGYS Mirukaj (ALB)	P1 P2 P3 4 1 0	32	1/1	BLR	P1 P2 P3 1 0 0	29	0/0	TUR	P1 P2 P3 0 0 0				
19	1/1	NOUMONVI MÃ©lonin (FRA)	P1 P2 P3 1 0 0					29	0/0	TUR	P1 P2 P3 0 0 0				
20	3/9	GEGESHIDZE V. (GEO)	P1 P2 P3 3 6 0					29	0/0	TUR	P1 P2 P3 0 0 0				
21	0/0	ROED C. (DEN)	P1 P2 P3 0 0 0					29	0/0	TUR	P1 P2 P3 0 0 0				
22	3/2	MARINOV H. (BUL)	P1 P2 P3 1 1 0					29	0/0	TUR	P1 P2 P3 0 0 0				
23	3/2	LORINCZ Viktor (HUN)	P1 P2 P3 1 1 0					29	0/0	TUR	P1 P2 P3 0 0 0				
24	0/1	HIETANIEMI R. (FIN)	P1 P2 P3 1 0 0					29	0/0	TUR	P1 P2 P3 0 0 0				
25	0/0	KESSIDIS L. (GRE)	P1 P2 P3 0 0 0					29	0/0	TUR	P1 P2 P3 0 0 0				
26	3/5	HOVHANNISYAN Hrach (ARM)	P1 P2 P3 3 2 0					29	0/0	TUR	P1 P2 P3 0 0 0				
27	0/0	GARCIA PEREZ P. (ESP)	P1 P2 P3 0 0 0					29	0/0	TUR	P1 P2 P3 0 0 0				
28	3/3	APS Eerik (EST)	P1 P2 P3 1 2 0					29	0/0	TUR	P1 P2 P3 0 0 0				
29	3/2	YILDIRIM Ahmet (TUR)	P1 P2 P3 1 1 0					29	0/0	TUR	P1 P2 P3 0 0 0				
30	0/0	KNEZEVIC Nikola (MNE)	P1 P2 P3 0 0 0					29	0/0	TUR	P1 P2 P3 0 0 0				
31	3/2	ZUGAJ Nenad (CRO)	P1 P2 P3 0 1 1					29	0/0	TUR	P1 P2 P3 0 0 0				
32	1/1	HAMZATAU Javid (BLR)	P1 P2 P3 1 0 0					29	0/0	TUR	P1 P2 P3 0 0 0				

22 MARINOV H. (BUL)

Classement

Cl	Pays	Nom
1	BUL	MARINOV H.
2	POL	JANIKOWSKI Damian
3	UKR	BELENIUK Zhan
3	HUN	LORINCZ Viktor
5	LTU	ADOMAITIS Laimutis
5	EST	APS Eerik
7	GEO	GEGESHIDZE Vladimer
8	AZE	TAHMASEBI S.
9	ITA	MINGUZZI Andrea
10	TUR	YILDIRIM Ahmet
11	CZE	OMAROV Artur
12	CRO	ZUGAJ Nenad
13	SUI	SUPPIGER Thomas
14	ARM	HOVHANNISYAN Hrach
15	MDA	ZGHEREA Serghei
16	SVK	MIHALIK Marian
17	SWE	PETTERSSON J.
18	ALB	ERGYS Mirukaj
19	GER	AZISIRS Ramsin
20	AUT	HRUSTANOVIC Amer
21	ROU	TAMAS Attila Gheza
22	BLR	HAMZATAU Javid
23	FRA	NOUMONVI MÃ©lonin
24	FIN	HIETANIEMI R.
25	MNE	KNEZEVIC Nikola
26	RUS	MISHIN Aleksey
26	ESP	GARCIA PEREZ P.
26	LAT	ROMANOVSKIS Z.
29	NOR	ISAKSEN J.
30	GRE	KESSIDIS L.
31	SRB	BALO Petar
31	DEN	ROED Christian Brix

REPECHAGE

REPECHAGE FINALISTE 1

7	3/3	UKR	P1 P2 P3 2 1 0	7	3/6	UKR	P1 P2 P3 4 2 0	7	5/13	UKR	P1 P2 P3 8 5 0
6	0/0	SWE	P1 P2 P3 0 0 0	1	1/2	ITA	P1 P2 P3 2 0 0	9	0/3	LTU	P1 P2 P3 0 3 0

7 BELENIUK Zhan (UKR)

Médaille de Bronze

REPECHAGE FINALISTE 2

21	0/0	DEN	P1 P2 P3 0 0 0	23	3/3	HUN	P1 P2 P3 0 2 1	23	4/2	HUN	P1 P2 P3 0 1 1
23	5/5	HUN	P1 P2 P3 1 4 0	20	1/3	GEO	P1 P2 P3 1 1 1	28	1/1	EST	P1 P2 P3 1 0 0

23 LORINCZ Viktor (HUN)

Médaille de Bronze



Classement

Senior European Championship 2012



STYLE : GR 84 kg

1 - Or / Gold

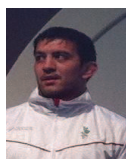

MARINOV Hristo Diyanov

2 - Argent / Silver

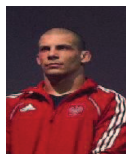

JANIKOWSKI Damian

3 - Bronze



BELENIUK Zhan

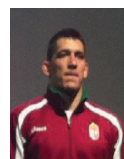

LORINCZ Viktor

Classement	Nom - Name	Pays - Country
1	MARINOV H.	BUL
2	JANIKOWSKI Damian	POL
3	BELENIUK Zhan	UKR
3	LORINCZ Viktor	HUN
5	ADOMAITIS Laimutis	LTU
5	APS Eerik	EST
7	GEGESHIDZE Vladimer	GEO
8	TAHMASEBI S.	AZE
9	MINGUZZI Andrea	ITA
10	YILDIRIM Ahmet	TUR
11	OMAROV Artur	CZE
12	ZUGAJ Nenad	CRO
13	SUPPIGER Thomas	SUI
14	HOVHANNISYAN Hrach	ARM
15	ZGHEREA Serghei	MDA
16	MIHALIK Marian	SVK
17	PETTERSSON J.	SWE
18	ERGYS Mirukaj	ALB
19	AZIZSIR Ramsin	GER
20	HRUSTANOVIC Amer	AUT
21	TAMAS Attila Gheza	ROU
22	HAMZATAU Javid	BLR
23	NOUMONVI MÃ©lonin	FRA
24	HIETANIEMI R.	FIN
25	KNEZEVIC Nikola	MNE
26	MISHIN Aleksey	RUS
26	GARCIA PEREZ P.	ESP
26	ROMANOVSKIS Z.	LAT
29	ISAKSEN J.	NOR
30	KESSIDIS L.	GRE
31	ISAKSEN J.	SRB
31	ROED Christian Brix	DEN



Feuille de compétition / Competition Sheet

Senior European Championship 2012



STYLE : GR 96 kg

QUALIFICATION		1/8 FINALE		1/4 FINALE		1/2 FINALE		FINALE	
1	TOOM Alo (EST)	1	1 EST	2	3 AZE	2	0 AZE	6	0 LTU
2	QADABADZE Shalva (AZE)	2	3 AZE	3	0 BUL	6	3/4 LTU	6	3/2 LTU
3	DINCHEV K. (BUL)	3	3 BUL	7	1 CZE	6	3/6 ARM	16	3/8 ARM
4	FRANJKOVIC Dejan (SRB)	4	0 SRB	8	1 ITA	11	0 UKR	16	3/8 ARM
5	FEDOROWICZ D. (POL)	5	1 POL	10	1 TUR	11	3 UKR	22	0 GER
6	EZERSKIS Mindaugas (LTU)	6	3 LTU	11	8 UKR	16	3/2 ARM	22	3/6 GER
7	VALA David (CZE)	7	3 CZE	14	0 HUN	16	3/2 ARM		
8	SCIBILIA Beniamino (ITA)	8	1 ITA	14	3 HUN	16	3/2 ARM		
9	AVANESYAN Robert (ISR)	10	1 TUR	16	3 ARM	16	3/2 ARM		
10	TACYILDIZ Ahmet (TUR)	11	3 UKR	16	3/6 ARM	16	3/8 ARM		
11	RUTENKO Sergii (UKR)	11	8 UKR	17	1 GEO	19	1/2 RUS		
12	KOSZEGHY Filip (SVK)	14	0 HUN	17	3 GEO	19	3 RUS		
13	KALLIO Timo Antero (FIN)	14	3 HUN	19	3 RUS	22	0 GER		
14	RIZMAJER Gyorgy (HUN)	16	3 ARM	22	3 GER	22	3/6 GER		
15	HOGAC Sinisa (CRO)	16	3/6 ARM	22	3/5 GER	22	3/6 GER		
16	ALEKSANYAN Artur (ARM)	17	1 GEO	22	3/5 GER	22	3/6 GER		
17	JABIDZE Soso (GEO)	17	3 GEO	22	3/5 GER	22	3/6 GER		
18	DZEINICHENKA T. (BLR)	19	1/2 RUS	22	3/5 GER	22	3/6 GER		
19	TOTROV Rustam (RUS)	19	3 RUS	22	3/5 GER	22	3/6 GER		
20	LIDBERG J. (SWE)	22	0 GER	22	3/5 GER	22	3/6 GER		
21	POIKILIDIS A. (GRE)	22	3 GER	22	3/5 GER	22	3/6 GER		
22	HASSLER O. (GER)	22	3/5 GER	22	3/5 GER	22	3/6 GER		
23	MOCANU Andrian (MDA)	24	0 ROU	22	3/5 GER	22	3/6 GER		
24	PAPP R. (ROU)	24	0 ROU	22	3/5 GER	22	3/6 GER		

16 ALEKSANYAN Artur (ARM)

Classement

Cl	Pays	Nom
1	ARM	ALEKSANYAN Artur
2	LTU	EZERSKIS Mindaugas
3	AZE	QADABADZE Shalva
3	UKR	RUTENKO Sergii
5	POL	FEDOROWICZ D.
5	GER	HASSLER O.
7	RUS	TOTROV Rustam
8	HUN	RIZMAJER Gyorgy
9	CZE	VALA David
10	GEO	JABIDZE Soso
11	TUR	TACYILDIZ Ahmet
12	BUL	DINCHEV K.
13	ROU	PAPP R.
14	FIN	KALLIO Timo Antero
15	ITA	SCIBILIA Beniamino
15	SWE	LIDBERG J.
17	EST	TOOM Alo
18	MDA	MOCANU Andrian
18	GRE	POIKILIDIS A.
20	SVK	KOSZEGHY Filip
20	SRB	FRANJKOVIC Dejan
20	ISR	AVANESYAN Robert
23	BLR	DZEINICHENKA T.
24	CRO	HOGAC Sinisa

REPECHAGE

REPECHAGE FINALISTE 1

5	3/2 POL	P1 P2 P3	0 1 1	5	1/1 POL	P1 P2 P3	1 0 0
7	1/1 CZE	P1 P2 P3	1 0 0	2	3/4 AZE	P1 P2 P3	3 1 0
				2 QADABADZE Shalva (AZE)			

Médaille de Bronze

REPECHAGE FINALISTE 2

15	0/0 CRO	P1 P2 P3	0 0 0	14	0/0 HUN	P1 P2 P3	0 0 0
14	3/3 HUN	P1 P2 P3	1 2 0	11	3/4 UKR	P1 P2 P3	1 3 0
				11 RUTENKO Sergii (UKR)			

Médaille de Bronze

Classement**Senior European Championship 2012**

STYLE : GR 96 kg

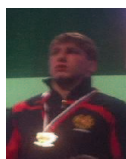
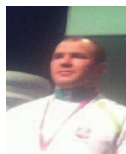
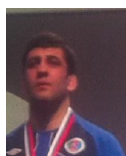
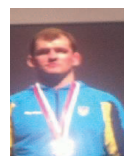
**1 - Or / Gold****ALEKSANYAN Artur****2 - Argent / Silver****EZERSKIS Mindaugas****3 - Bronze****QADABADZE Shalva****RUTENKO Sergii**

<i>Classement</i>	<i>Nom - Name</i>	<i>Pays - Country</i>
1	ALEKSANYAN Artur	ARM
2	EZERSKIS Mindaugas	LTU
3	QADABADZE Shalva	AZE
3	RUTENKO Sergii	UKR
5	FEDOROWICZ D.	POL
5	HASSLER O.	GER
7	TOTROV Rustam	RUS
8	RIZMAJER Gyorgy	HUN
9	VALA David	CZE
10	JABIDZE Soso	GEO
11	TACYILDIZ Ahmet	TUR
12	DINCHEV K.	BUL
13	PAPP R.	ROU
14	KALLIO Timo Antero	FIN
15	SCIBILIA Beniamino	ITA
15	LIDBERG J.	SWE
17	TOOM Alo	EST
18	POIKILIDIS A.	GRE
18	MOCANU Andrian	MDA
20	KOSZEGHY Filip	SVK
20	FRANJKOVIC Dejan	SRB
20	AVANESYAN Robert	ISR
23	DZEINICHENKA T.	BLR
24	HOGAC Sinisa	CRO



Feuille de compétition / Competition Sheet

Senior European Championship 2012



STYLE : GR 120 kg

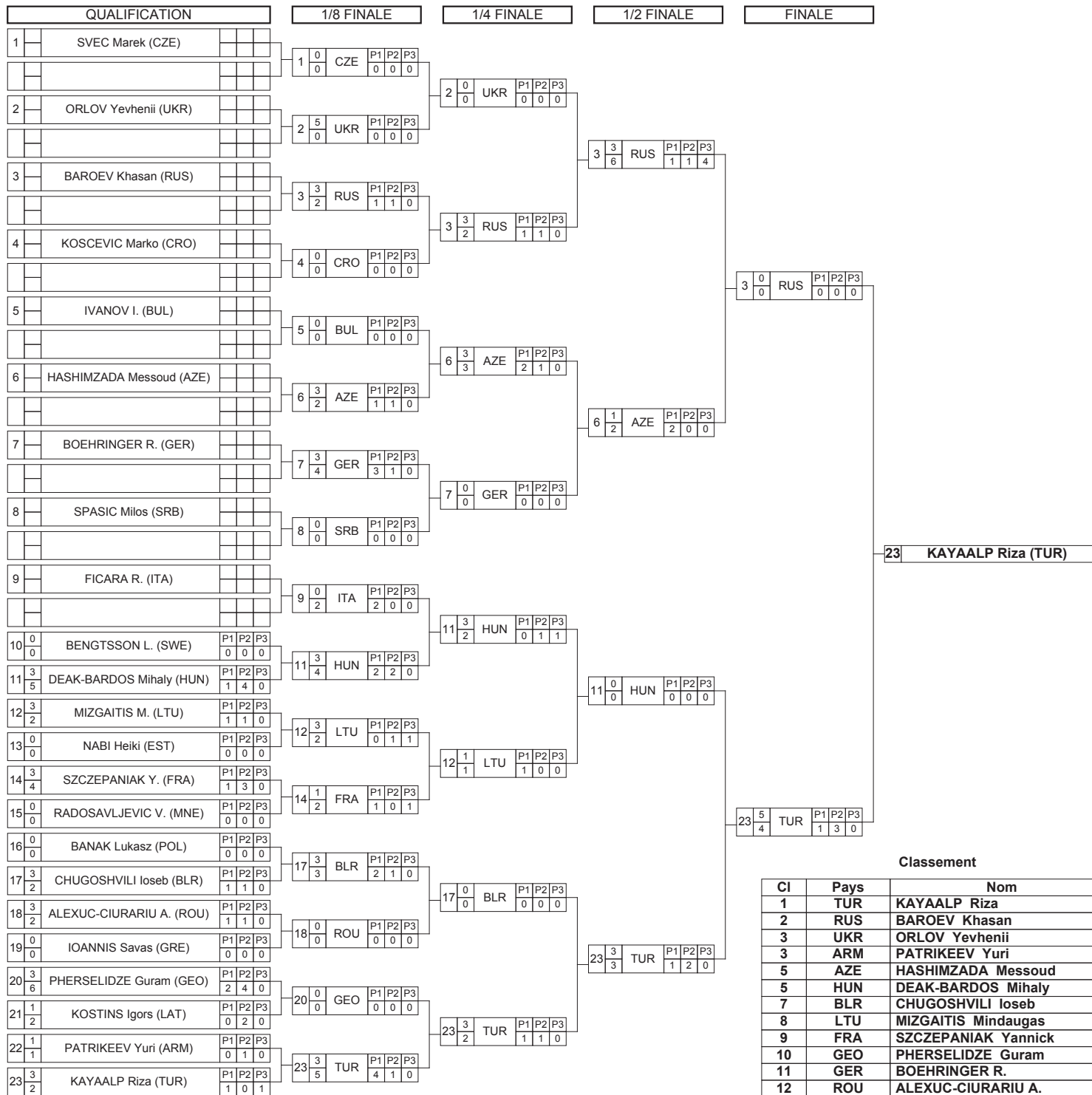

23 KAYAALP Riza (TUR)

Classement

Cl	Pays	Nom
1	TUR	KAYAALP Riza
2	RUS	BAROEV Khasan
3	UKR	ORLOV Yevhenii
3	ARM	PATRIKEEV Yuri
5	AZE	HASHIMZADA Messoud
5	HUN	DEAK-BARDOS Mihaly
7	BLR	CHUGOSHVILI Ioseb
8	LTU	MIZGAITIS Mindaugas
9	FRA	SZCZEPANIAK Yannick
10	GEO	PHERSELIDZE Guram
11	GER	BOEHRINGER R.
12	ROU	ALEXUC-CIURARIU A.
13	LAT	KOSTINS Igors
14	ITA	FICARA R.
15	CZE	SVEC Marek
16	BUL	IVANOV I.
16	POL	BANAK Lukasz
16	GRE	IOANNIS Savas
16	EST	NABI Heiki
20	MNE	RADOSAVLJEVIC V.
20	SRB	SPASIC Milos
22	SWE	BENGTTSSON Leif Eddy
22	CRO	KOSCEVIC Marko

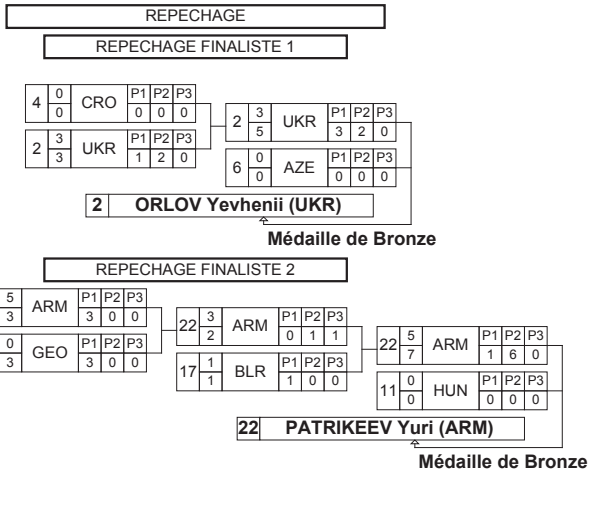



Classement

Senior European Championship 2012

STYLE : GR 120 kg



1 - Or / Gold

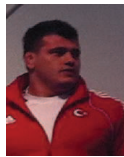

KAYAALP Riza

2 - Argent / Silver



BAROEV Khasan

3 - Bronze



ORLOV Yevhenii

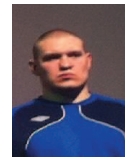

PATRIKEEV Yuri

Classement	Nom - Name	Pays - Country
1	KAYAALP Riza	TUR
2	BAROEV Khasan	RUS
3	ORLOV Yevhenii	UKR
3	PATRIKEEV Yuri	ARM
5	DEAK-BARDOS Mihaly	HUN
5	HASHIMZADA Messoud	AZE
7	CHUGOSHVILI Ioseb	BLR
8	MIZGAITIS Mindaugas	LTU
9	SZCZEPANIAK Yannick	FRA
10	PHERSELIDZE Guram	GEO
11	BOEHRINGER R.	GER
12	ALEXUC-CIURARIU A.	ROU
13	KOSTINS Igors	LAT
14	FICARA R.	ITA
15	SVEC Marek	CZE
16	NABI Heiki	EST
16	IOANNIS Savas	GRE
16	BANAK Lukasz	POL
16	IVANOV I.	BUL
20	RADOSAVLJEVIC V.	MNE
20	SPASIC Milos	SRB
22	BENGTSSON Leif Eddy	SWE
22	KOSCEVIC Marko	CRO



Classement par équipe / Teams ranking

Senior European Championship 2012



STYLE GR

Rang	Equipe	120 KG	55 KG	60 KG	66 KG	74 KG	84 KG	96 KG	TOTAL
1	RUS	9	6	8	8	10		4	45
2	UKR	8	6			6	8	8	36
3	AZE	6	10	6		1	3	8	34
4	BUL		8	9	3		10		30
5	ARM	8		1		8		10	27
6	HUN	6	9				8	3	26
7	LTU	3				8	6	9	26
8	TUR	10	8			4	1		23
9	GEO	1		4		9	4	1	19
10	BLR	4	2	6	6				18
11	POL					2	9	6	17
12	GER				10			6	16
13	SRB			8	6				14
14	FRA	2		3	1	6			12
15	SVK			10					10
16	ROU		1		9				10
17	SWE			2	8				10
18	CRO		3		2	3			8
19	EST						6		6
20	MDA		4						4
21	POR				4				4
22	CZE							2	2
23	ITA						2		2
24	ALB								0
24	AUT								0
24	DEN								0
24	ESP								0
24	FIN								0
24	GBR								0
24	GRE								0
24	ISR								0
24	LAT								0
24	MNE								0



Classement par équipe / Teams ranking

Senior European Championship 2012



STYLE GR

Rang	Equipe	120 KG	55 KG	60 KG	66 KG	74 KG	84 KG	96 KG	TOTAL
24	NOR								0
24	SLO								0
24	SUI								0

SENIOR WRESTLING ECH - BELGRAD (SRB) - 2012. / all competitors - medals

sn	Nat.	FW					FS					GR					TOTAL						
		Numb. comp.		Medals			Total points		Numb. comp.		Medals			Total points		Numb. comp.		Medals			Total points		
		I	II	III	tot.	Med	Total	I	II	III	tot.	Med	Total	I	II	III	tot.	Med	Total	I	II	III	tot.
1	RUS	7	1	4	5	53	7	4	2	6	52	7	1	1	2	4	45	21	5	2	8	15	150
2	UKR	7	4	3	7	67	7	1	1	1	30	7	1	3	3	36	21	4	4	3	11	133	
3	BUL	4		1	1	15	7	3	1	4	49	7	1	1	3	30	18	1	4	3	8	94	
4	AZE	7	2	2	2	31	7	1	1	2	26	7	1	1	2	34	21	2	0	4	6	91	
5	TUR	6		1	1	14	7	1	2	3	44	7	1	1	2	23	20	2	0	4	6	81	
6	GEO						7	1	2	5	60	7	1	1	0	19	14	1	3	2	6	79	
7	HUN	4			0	9	7	1	2	3	27	6	1	1	2	26	17	0	2	3	5	62	
8	BLR	7			0	13	7		2	2	28	7			0	18	21	0	0	2	2	59	
9	POL	5	1	1	2	30	7			0	7	6	1		1	17	18	1	1	1	3	54	
10	ROU	7	1	1	2	23	7	1	1	1	16	7	1	1	1	10	21	0	2	2	4	49	
11	ARM	1			0	0	7	1	1	1	19	7	1	2	3	27	15	1	0	3	4	46	
12	GER	7	2	2	2	20	7			0	9	7	1		1	16	21	1	0	2	3	45	
13	SWE	7	1	1	2	31						7		1	1	10	14	1	1	1	3	41	
14	LTU	1			0	0	3			0	0	6	1	1	2	26	10	0	1	1	2	26	
15	LAT	4		1	1	15	3			0	6	4			0	0	11	0	1	0	1	21	
16	MDA	3		1	1	9	7			0	8	6			0	4	16	0	0	1	1	21	
17	FRA	4			0	7	3			0	0	5			0	0	12	0	0	0	0	19	
18	SRB	7			0	3	7			0	0	7	1	1	1	14	21	0	0	1	1	17	
19	NOR	3	1		1	16						4			0	0	7	1	0	0	1	16	
20	ITA	5			0	9	3			0	3	7			0	2	15	0	0	0	0	14	
21	SVK	1			0	0	6			0	3	5	1		1	10	12	1	0	0	1	13	
22	ESP	4		1	1	8	4			0	2	2			0	0	10	0	0	1	1	10	
23	GRE	3			0	6	6			0	2	7			0	0	16	0	0	0	0	8	
24	CRO											7			0	8	7	0	0	0	0	8	
25	EST	2			0	0	1			0	0	4			0	6	7	0	0	0	0	6	
26	ISR	1			0	2	1			0	3	4			0	0	6	0	0	0	0	5	
27	FIN	2			0	4	2			0	0	5			0	0	8	0	0	0	0	4	
28	MNE	1			0	4	1					2			0	0	3	0	0	0	0	4	
29	NED	1			0	4											1	0	0	0	0	4	
30	POR	2			0	0						2			0	4	4	0	0	0	0	4	
31	ALB						3			0	3	3			0	0	5	0	0	0	0	3	
32	AUT	3			0	3	3			0	0	2			0	0	9	0	0	0	0	3	
33	SUI	3			0	3	3			0	0	4			0	0	10	0	0	0	0	3	
34	GBR	2			0	0	4			0	2	1			0	0	7	0	0	0	0	2	
35	CZE	2			0	0	2			0	0	5			0	2	8	0	0	0	0	2	
36	CYP						2			0	0						2	0	0	0	0	0	
37	IRL						1			0	0				0	0	1	0	0	0	0	0	
38	MKD						6			0	0						6	0	0	0	0	0	
39	MON						1			0	0						1	0	0	0	0	0	
40	DEN											3					3	0	0	0	0	0	
41	SLO											1					1	0	0	0	0	0	
Total		123	7	7	14	28	153	7	7	14	28	185	7	7	14	28	399	461	21	21	42	84	1197
NATION		32					33					36					41						

SENIOR WRESTLING ECH - BELGRAD (SRB) - 2012.

All medals - Olympic ranking

sn	Nat.	FW				FS				GR				TOTAL			
		Medals			Med	Medals			Med	Medals			Med	Medals			Med
		I	II	III	tot.	I	II	III	tot.	I	II	III	tot.	I	II	III	tot.
1	RUS		1	4	5	4		2	6	1	1	2	4	5	2	8	15
2	UKR	4	3		7		1		1			3	3	4	4	3	11
3	AZE			2	2	1		1	2	1		1	2	2	0	4	6
4	TUR			1	1	1		2	3	1		1	2	2	0	4	6
5	BUL			1	1		3	1	4	1	1	1	3	1	4	3	8
6	GEO					1	2	2	5		1		1	1	3	2	6
7	SWE	1	1		2							1	1	1	1	1	3
8	POL	1		1	2				0		1		1	1	1	1	3
9	ARM				0			1	1	1		2	3	1	0	3	4
10	GER			2	2				0	1			1	1	0	2	3
11	NOR	1			1				0				0	1	0	0	1
11	SVK				0				0	1			1	1	0	0	1
13	HUN				0		1	2	3		1	1	2	0	2	3	5
14	ROU		1	1	2			1	1		1		1	0	2	2	4
15	LTU				0				0		1	1	2	0	1	1	2
16	LAT		1		1				0				0	0	1	0	1
17	BLR				0			2	2				0	0	0	2	2
18	MDA			1	1				0				0	0	0	1	1
18	SRB				0				0		1	1	1	0	0	1	1
18	ESP			1	1				0				0	0	0	1	1
21	FRA				0				0				0	0	0	0	0
22	ITA				0				0				0	0	0	0	0
23	GRE				0				0				0	0	0	0	0
24	CRO				0				0				0	0	0	0	0
25	EST				0				0				0	0	0	0	0
26	ISR				0				0				0	0	0	0	0
27	FIN				0				0				0	0	0	0	0
28	MNE				0				0				0	0	0	0	0
29	NED				0				0				0	0	0	0	0
30	POR				0				0				0	0	0	0	0
31	ALB				0				0				0	0	0	0	0
32	AUT				0				0				0	0	0	0	0
33	SUI				0				0				0	0	0	0	0
34	GBR				0				0				0	0	0	0	0
35	CZE				0				0				0	0	0	0	0
36	CYP				0				0				0	0	0	0	0
37	IRL				0				0				0	0	0	0	0
38	MKD				0				0				0	0	0	0	0
39	MON				0				0				0	0	0	0	0
40	DEN				0				0				0	0	0	0	0
41	SLO				0				0				0	0	0	0	0
Total =		7	7	14	28	7	7	14	28	7	7	14	28	21	21	42	84

GR - SENIOR WRESTLING ECH - BELGRAD (SRB) - 2012.**Medals - Olympic ranking**

		GR			
		Medals			Med
sn	Nat.	I	II	III	tot.
1	RUS	1	1	2	4
2	BUL	1	1	1	3
3	ARM	1		2	3
4	AZE	1		1	2
5	TUR	1		1	2
6	GER	1			1
6	SVK	1			1
8	HUN		1	1	2
8	LTU		1	1	2
10	POL		1		1
10	ROU		1		1
10	GEO		1		1
13	UKR			3	3
14	SRB			1	1
14	SWE			1	1
16	ALB				0
17	AUT				0
18	BLR				0
19	CRO				0
20	CZE				0
21	DEN				0
22	ESP				0
23	EST				0
24	FIN				0
25	FRA				0
26	GBR				0
27	GRE				0
28	ISR				0
29	ITA				0
30	LAT				0
31	MDA				0
32	MNE				0
33	NOR				0
34	POR				0
35	SLO				0
36	SUI				0
Total =		7	7	14	28

FS - SENIOR WRESTLING ECH - BELGRAD (SRB) - 2012 /**Medals - Olympic ranking**

		FS			
		Medals			Med
sn	Nat.	I	II	III	tot.
1	RUS	4		2	6
2	GEO	1	2	2	5
3	TUR	1		2	3
4	AZE	1		1	2
5	BUL		3	1	4
6	UKR		1		1
7	HUN		1	2	3
8	ROU			1	1
9	ARM			1	1
10	BLR			2	2
11	ALB				0
12	AUT				0
13	CYP				0
14	CZE				0
15	ESP				0
16	EST				0
17	FIN				0
18	FRA				0
19	GBR				0
20	GER				0
21	GRE				0
22	IRL				0
23	ISR				0
24	ITA				0
25	LAT				0
26	LTU				0
27	MDA				0
28	MKD				0
29	MON				0
30	POL				0
31	SRB				0
32	SUI				0
33	SVK				0
Total =		7	7	14	28

FW - SENIOR WRESTLING ECH - BELGRAD (SRB) - 2012.**Medals - Olympic ranking**

		FW			
		Medals			Med
sn	Nat.	I	II	III	tot.
1	UKR	4	3		7
2	SWE	1	1		2
3	POL	1		1	2
4	NOR	1			1
5	RUS		1	4	5
6	ROU		1	1	2
7	LAT		1		1
8	AZE			2	2
8	GER			2	2
10	TUR			1	1
10	BUL			1	1
10	MDA			1	1
10	ESP			1	1
14	ARM				0
15	AUT				0
16	BLR				0
17	CZE				0
18	EST				0
19	FIN				0
20	FRA				0
21	GBR				0
22	GRE				0
23	HUN				0
24	ISR				0
25	ITA				0
26	LTU				0
27	MNE				0
28	NED				0
29	POR				0
30	SRB				0
31	SUI				0
32	SVK				0
Total =		7	7	14	28

SENIOR WRESTLING ECH - BELGRAD (SRB) - 2012

Number competitors all styles

sn	Nat.	FW	FS	GR	Total
		Numb . comp.	Numb . comp.	Numb . comp.	
1	RUS	7	7	7	21
2	UKR	7	7	7	21
3	AZE	7	7	7	21
4	BLR	7	7	7	21
5	ROU	7	7	7	21
6	GER	7	7	7	21
7	SRB	7	7	7	21
8	TUR	6	7	7	20
9	BUL	4	7	7	18
10	POL	5	7	6	18
11	HUN	4	7	6	17
12	MDA	3	7	6	16
13	GRE	3	6	7	16
14	ARM	1	7	7	15
15	ITA	5	3	7	15
16	GEO		7	7	14
17	SWE	7		7	14
18	FRA	4	3	5	12
19	SVK	1	6	5	12
20	LAT	4	3	4	11
21	LTU	1	3	6	10
22	ESP	4	4	2	10
23	SUI	3	3	4	10
24	AUT	3	3	3	9
25	FIN	2	1	5	8
26	CZE	2	1	5	8
27	NOR	3		4	7
28	CRO			7	7
29	EST	2	1	4	7
30	GBR	2	4	1	7
31	ISR	1	1	4	6
32	MKD		6		6
33	ALB		3	2	5
34	POR	2		2	4
35	MNE	1		2	3
36	DEN			3	3
37	CYP		2		2
38	NED	1			1
39	IRL		1		1
40	MON		1		1
41	SLO			1	1
Total com.		123	153	185	461
NATION		32	33	36	41